

127-1262

AOP534 LED-FT

**we-ef**



### Description

IP55. Classe I. Classe II sur demande. IK10. Corps en fonte d'aluminium. Visserie inox avec traitement PCS. Protection contre la corrosion 5CE. Joint silicone. Vasque en polycarbonate. Lentille diffusante FT 360° LED en PMMA. Le parasurtenseur et livré avec un boîtier contre les surtensions.

Hauteur de mât recommandée selon la puissance: 3 à 4.5m.

Poids	7.60 kg
Distribution de la lumière	symétrique, lentille diffusante circulaire 360° [C60]
Source lumineuse	LED-FT-24W / 700 mA - 3000 K
IRC	80
Alimentation électrique	ballast électronique
LEDs	1
Rated input power	27 W

### Rated lumens (lm)

LED Lumen	2885.4
Total Lumen	2885.4
Ta	25

### Flux lumineux nominal (lm)

LED Lumen	4220
Total Lumen	4220
Tc	25

### WE-EF Switzerland AG

Himmelrichstrasse 6, 6003 Luzern - Téléphone: +41 22 752 49 94

info.switzerland@we-ef.com - [https://we-ef.com/ch\\_fr](https://we-ef.com/ch_fr)

Sous réserve de modifications techniques et d'erreurs. - Généré le 23/11/2024

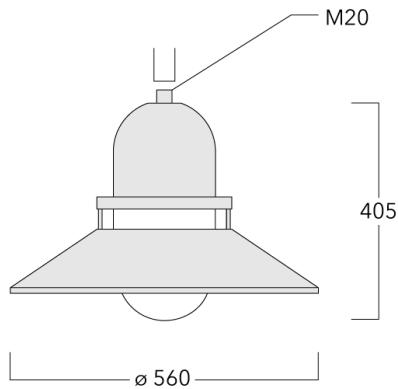

## Spécifications

### Description du matériel

Corps	Corps en fonte d'aluminium, visserie inox avec traitement PCS
Lentille	Vasque en polycarbonate
Couleurs	<div style="display: flex; align-items: center;"> <div style="width: 20px; height: 15px; background-color: black; margin-right: 5px;"></div> <span>RAL9004 Noir de sécurité</span> </div> <div style="display: flex; align-items: center; margin-top: 5px;"> <div style="width: 20px; height: 15px; background-color: gray; margin-right: 5px;"></div> <span>RAL9007 Aluminium gris</span> </div> <div style="display: flex; align-items: center; margin-top: 5px;"> <div style="width: 20px; height: 15px; background-color: darkgray; margin-right: 5px;"></div> <span>RAL7016 Gris anthracite</span> </div> <div style="display: flex; align-items: center; margin-top: 5px;"> <div style="width: 20px; height: 15px; background-color: lightgray; margin-right: 5px;"></div> <span>RAL9016 Blanc signalisation</span> </div>
Joint	Joint silicone
Visserie	PCS Inox avec revêtement polymère
IP	IP55
IK	IK10
Protection contre la corrosion	5CE
Surface exposée au vent	0.12 m <sup>2</sup>

### Description électrique

Alimentation électrique	220-240V / 50-60 Hz
Driver	Driver électronique. DALI
Power factor	> 0.9

#### WE-EF Switzerland AG

Himmelrichstrasse 6, 6003 Luzern - Téléphone: +41 22 752 49 94

info.switzerland@we-ef.com - [https://we-ef.com/ch\\_fr](https://we-ef.com/ch_fr)

Sous réserve de modifications techniques et d'erreurs. - Généré le 23/11/2024

**127-1262**

**AOP534 LED-FT**

**we-ef**

### **Informations complémentaires**

---

Durée de vie Ta=25° L70B50 > 50000h

Classe d'efficacité  
énergétique D

---

**WE-EF Switzerland AG**

Himmelrichstrasse 6, 6003 Luzern - Téléphone: +41 22 752 49 94

info.switzerland@we-ef.com - [https://we-ef.com/ch\\_fr](https://we-ef.com/ch_fr)

Sous réserve de modifications techniques et d'erreurs. - Généré le 23/11/2024

**127-1262**

**AOP534 LED-FT**

**we-ef**

## **Control**

### **Eco Step Dim® Basic**

Description	Référence
Eco Step Dim® Basic LED	430-0001

### **Eco Step Dim® Advanced**

Description	Référence
Eco Step Dim® Advanced LED	430-0002

#### **WE-EF Switzerland AG**

Himmelrichstrasse 6, 6003 Luzern - Téléphone: +41 22 752 49 94

info.switzerland@we-ef.com - [https://we-ef.com/ch\\_fr](https://we-ef.com/ch_fr)

Sous réserve de modifications techniques et d'erreurs. - Généré le 23/11/2024

## Accessoires d'installation

## Crosses murales et Crosses pour mât BA

Description	Référence	C1	D x L1	H1	H2	M1	Poids (kg)	C	H
BA0-420 crose murale	300-0152	460		1000	132	9	2	460	1000

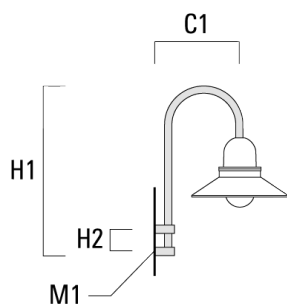

BA1-420 crose simple	300-0099	420	76 x 80	1000			4	420	1000
----------------------	----------	-----	---------	------	--	--	---	-----	------

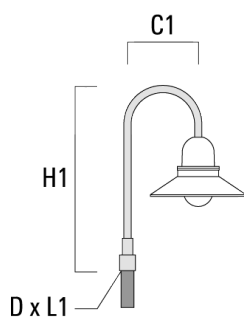

## AOP534 LED-FT

Description	Référence	C1	D x L1	H1	H2	M1	Poids (kg)	C	H
BA2-420 crosse double	300-0104	500	76 x 80	1000			8	500	1000

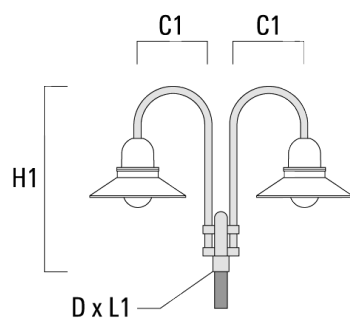

BA3-420 crosse triple	300-0109	500	76 x 80	1000			10	500	1000
-----------------------	----------	-----	---------	------	--	--	----	-----	------

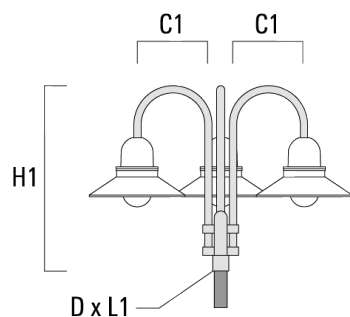

## Crosses murales et Crosses pour mât BC

Description	Référence	C1	H1	H2	M1	Poids (kg)	C	H
BC0-420 crosse murale	300-0808	460	1230	300	8	2.30	460	1230

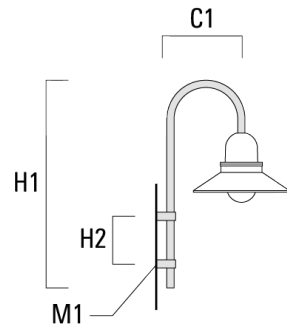

BC1-420 crosse simple	300-0768	500	1230	300	8	2.30	500	1230
-----------------------	----------	-----	------	-----	---	------	-----	------

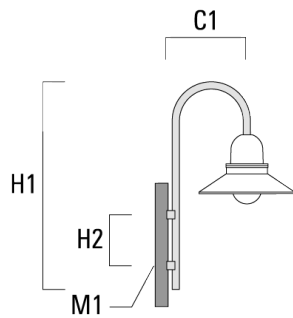

## AOP534 LED-FT

Description	Référence	C1	H1	H2	M1	Poids (kg)	C	H
BC2-420 crosse double	300-0767	500	1230	300	8	4.60	500	1230

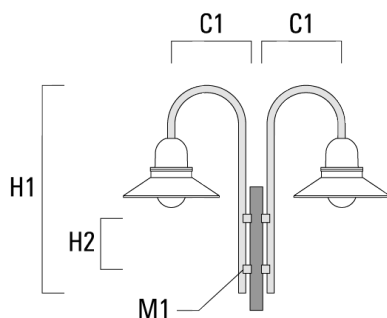

## Crosses murales et Crosses pour mât DA

Description	Référence	C1	C2	D × L1	H1	Poids (kg)	C	H
DA0-500 crosse murale	300-0146	510	70		650	5.70	510	650

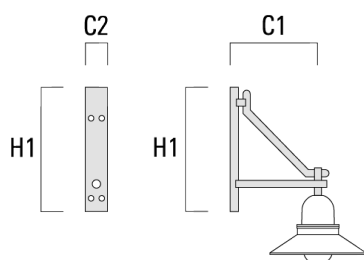

## WE-EF Switzerland AG

Himmelrichstrasse 6, 6003 Luzern - Téléphone: +41 22 752 49 94

info.switzerland@we-ef.com - [https://we-ef.com/ch\\_fr](https://we-ef.com/ch_fr)

Sous réserve de modifications techniques et d'erreurs. - Généré le 23/11/2024



## AOP534 LED-FT

Description	Référence	C1	C2	D x L1	H1	Poids (kg)	C	H
DA1-500 crosse simple	300-0138	510		76 x 80	700	5.70	510	700

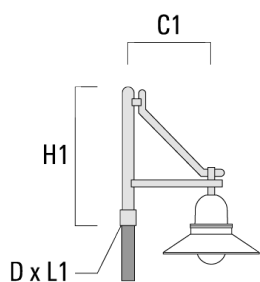

DA2-500 crosse double	300-0141	510		76 x 80	700	8.30	510	700
-----------------------	----------	-----	--	---------	-----	------	-----	-----

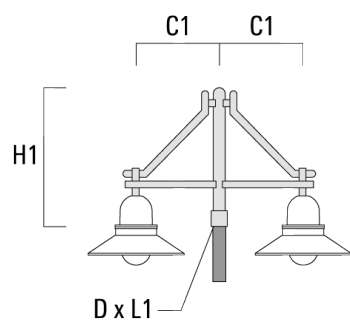

## AOP534 LED-FT

Description	Référence	C1	C2	D × L1	H1	Poids (kg)	C	H
DA3-500 crosse triple	300-0144	510		76 x 80	700	10.90	510	700

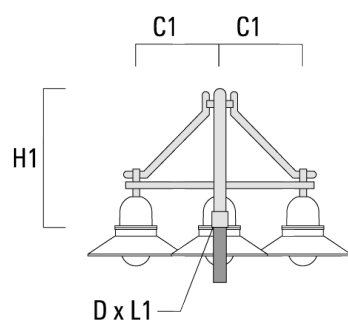

## Crosses murales et Crosses pour mât DB

Description	Référence	C1	C2	D × L1	H1	Poids (kg)	C	H
DB0-500 crosse murale	300-0169	510	70		650	5.50	510	650

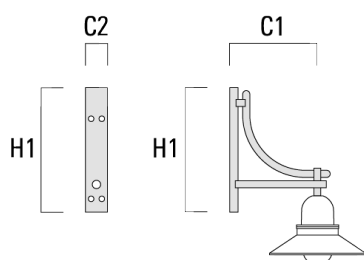

## AOP534 LED-FT

Description	Référence	C1	C2	D x L1	H1	Poids (kg)	C	H
DB1-500 crosse single	300-0190	510		76 x 80	700	5.50	510	700

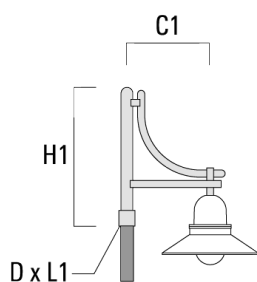

DB2-500 crosse double	300-0191	510		76 x 80	700	7.90	510	700
-----------------------	----------	-----	--	---------	-----	------	-----	-----

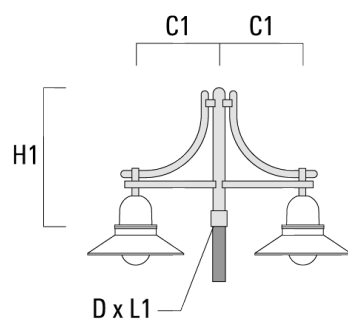

## AOP534 LED-FT

Description	Référence	C1	C2	D × L1	H1	Poids (kg)	C	H
DB3-500 crosse triple	300-0192	510		76 x 80	700	10.30	510	700

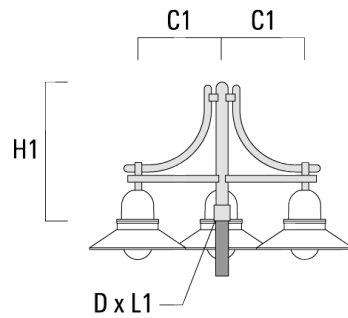

## Crosses murales et Crosses pour mât DS

Description	Référence	C1	C2	D × L1	H1	Poids (kg)	C	H
DS0-500 crosse murale	300-0064	510	70		650	2.50	510	650

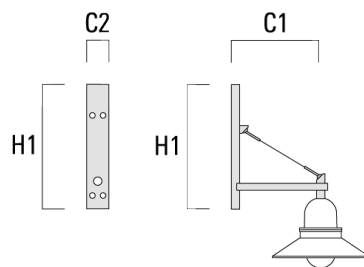

## AOP534 LED-FT

Description	Référence	C1	C2	D x L1	H1	Poids (kg)	C	H
DS1-500 crosse simple	300-0063	510		76 x 80	725	3.90	510	725

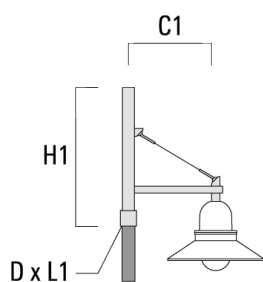

DS2-500 crosse double	300-0066	510		76 x 80	725	5.30	510	725
-----------------------	----------	-----	--	---------	-----	------	-----	-----

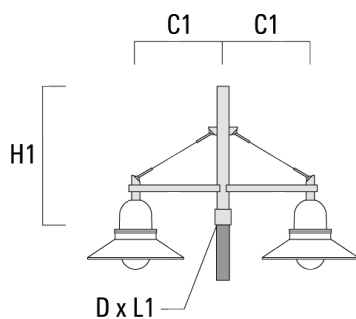

127-1262

AOP534 LED-FT

**we-ef**

Description	Référence	C1	C2	D x L1	H1	Poids (kg)	C	H
DS3-500 crosse triple	300-0069	510		76 x 80	725	6.70	510	725

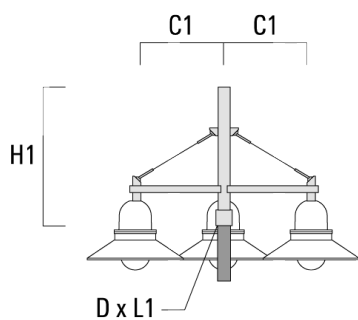

**WE-EF Switzerland AG**

Himmelrichstrasse 6, 6003 Luzern - Téléphone: +41 22 752 49 94

info.switzerland@we-ef.com - [https://we-ef.com/ch\\_fr](https://we-ef.com/ch_fr)

Sous réserve de modifications techniques et d'erreurs. - Généré le 23/11/2024