

127-1270

BSP534 LED

**we-ef**



### Description

IP55, Class I. Class II on request. IK10. Marine-grade, die-cast aluminium alloy. 5CE superior corrosion protection including PCS hardware. Silicone rubber gasket. Polycarbonate main lens. Integral EC electronic converter in thermally separated compartment. CAD-optimised optics for superior illumination and glare control. OLC® One LED Concept. Factory installed LED circuit board. The luminaire is factory-sealed and does not need to be opened during installation.

Optional 2200 K version available. To be specified at time of ordering.

Brackets to be ordered separately.

Weight	5.90 kg
Light distribution	asymmetric, side throw beam [S65]
Light source	LED-24/48W / 700 mA - 3000 K
CRI	80
Power supply	EC
LEDs	24
Rated input power	54 W

### Nominal Lumen (lm)

LED Lumen	290
Total Lumen	6960
Tj	85

### Rated lumens (lm)

LED Lumen	246.7
Total Lumen	5920.9
Ta	25

### Fagerhult Lighting Ltd

33-34 Dolben Street, SE1 0UQ London, United Kingdom

<https://we-ef.com/uk>

Subject to technical changes and errors. - Generated on 23/11/2024

127-1270



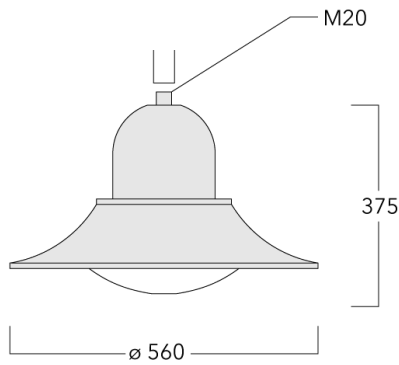

BSP534 LED

we-ef



## Specifications

### Material description

Body	Marine-grade, die-cast aluminium alloy
Lens	Polycarbonate lens
Colours	 RAL9004 Signal black  RAL9006 White aluminium  RAL9007 Grey aluminium  RAL7016 Anthracite grey  RAL9016 Traffic white
Gasket	Silicone rubber gasket
Fasteners	PCS Polymer Coated Stainless Steel Hardware
Ingress protection	IP55
Impact resistance	IK10
Corrosion resistance	5CE
Windage	0.0930 m <sup>2</sup>

### Electrical description

Power supply	220-240V / 50-60 Hz
Driver / Ballast	Integral EC electronic converter. DALI
Power factor	> 0.9
Surge protection	6/6 kV (optional SP10)

#### Fagerhult Lighting Ltd

33-34 Dolben Street, SE1 0UQ London, United Kingdom

<https://we-ef.com/uk>

Subject to technical changes and errors. - Generated on 23/11/2024

**127-1270**

**BSP534 LED**

**we-ef**

**Additional information**

---

Lifetime Ta=25° L90B10 > 90000h

Energy efficiency class C-D (Light source)

---

**127-1270**

**BSP534 LED**

**we-ef**

## **Control**

### **Eco Step Dim® Basic**

Description	Part ID
Eco Step Dim® Basic LED	430-0001

### **Eco Step Dim® Advanced**

Description	Part ID
Eco Step Dim® Advanced LED	430-0002

**Fagerhult Lighting Ltd**

33-34 Dolben Street, SE1 0UQ London, United Kingdom

<https://we-ef.com/uk>

Subject to technical changes and errors. - Generated on 23/11/2024

**Mounting Accessories**

**Wall and pole brackets BA**

Description	Part ID	C1	D × L1	H1	H2	M1	Weight (kg)	C	H
BA0-420 Wall bracket, single	300-0152	460		1000	132	9	2	460	1000

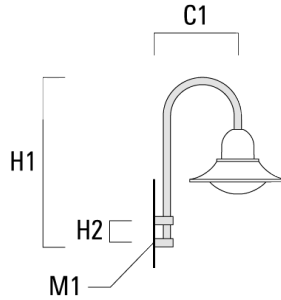

BA1-420 Pole bracket, single	300-0099	420	76 x 80	1000			4	420	1000
------------------------------	----------	-----	---------	------	--	--	---	-----	------

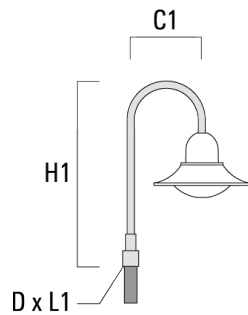

**BSP534 LED**

Description	Part ID	C1	D x L1	H1	H2	M1	Weight (kg)	C	H
BA2-420 Pole bracket, double	300-0104	500	76 x 80	1000			8	500	1000

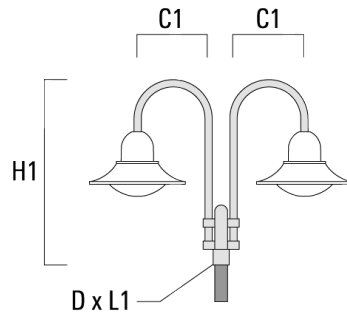

BA3-420 Pole bracket, triple	300-0109	500	76 x 80	1000			10	500	1000
------------------------------	----------	-----	---------	------	--	--	----	-----	------

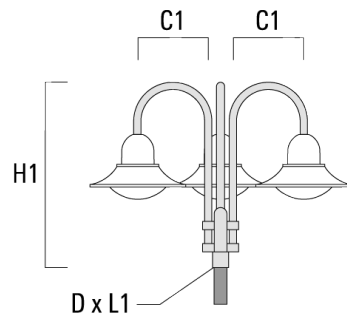

**Wall and pole brackets BC**

Description	Part ID	C1	H1	H2	M1	Weight (kg)	C	H
BC0-420 Wall bracket, single	300-0808	460	1230	300	8	2.30	460	1230

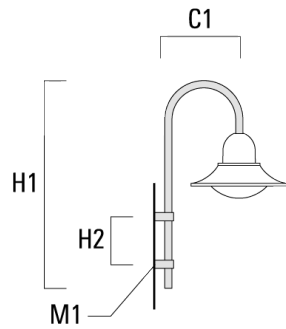

BC1-420 Pole bracket, single	300-0768	500	1230	300	8	2.30	500	1230
------------------------------	----------	-----	------	-----	---	------	-----	------

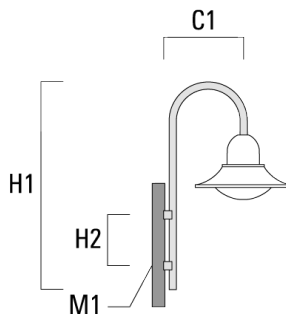

**BSP534 LED**

Description	Part ID	C1	H1	H2	M1	Weight (kg)	C	H
BC2-420 Pole bracket, double	300-0767	500	1230	300	8	4.60	500	1230

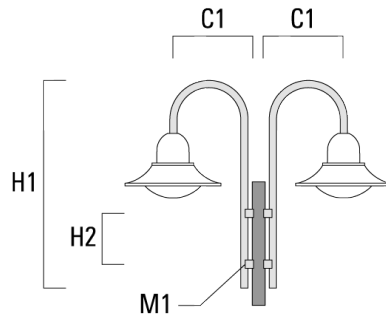

**Wall and pole brackets DA**

Description	Part ID	C1	C2	D × L1	H1	Weight (kg)	C	H
DA0-500 Wall bracket, single	300-0146	510	70		650	5.70	510	650

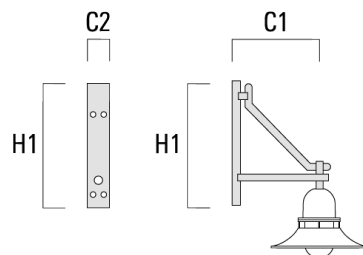



**BSP534 LED**

Description	Part ID	C1	C2	D x L1	H1	Weight (kg)	C	H
DA1-500 Pole bracket, single	300-0138	510		76 x 80	700	5.70	510	700

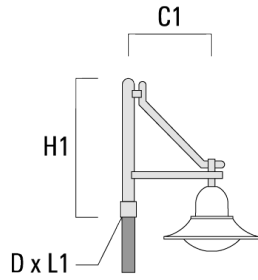

DA2-500 Pole bracket, double	300-0141	510		76 x 80	700	8.30	510	700
------------------------------	----------	-----	--	---------	-----	------	-----	-----

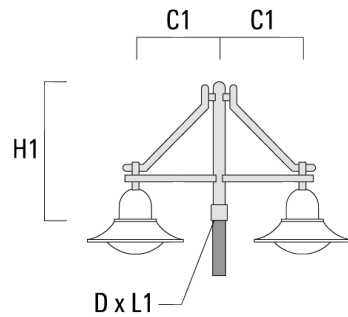

**BSP534 LED**

Description	Part ID	C1	C2	D × L1	H1	Weight (kg)	C	H
DA3-500 Pole bracket, triple	300-0144	510		76 x 80	700	10.90	510	700

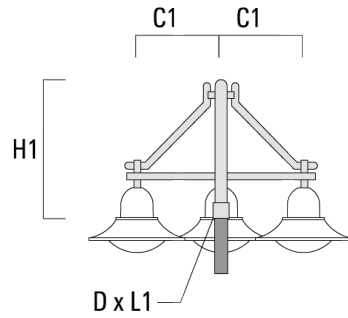

**Wall and pole brackets DB**

Description	Part ID	C1	C2	D × L1	H1	Weight (kg)	C	H
DB0-500 Wall bracket, single	300-0169	510	70		650	5.50	510	650

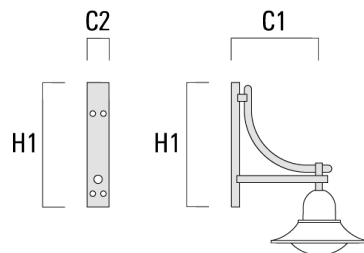

**BSP534 LED**

Description	Part ID	C1	C2	D x L1	H1	Weight (kg)	C	H
DB1-500 Pole bracket, single	300-0190	510		76 x 80	700	5.50	510	700

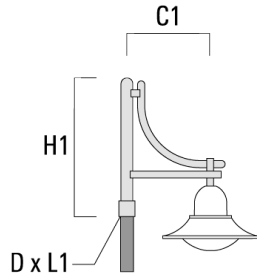

DB2-500 Pole bracket, double	300-0191	510		76 x 80	700	7.90	510	700
------------------------------	----------	-----	--	---------	-----	------	-----	-----

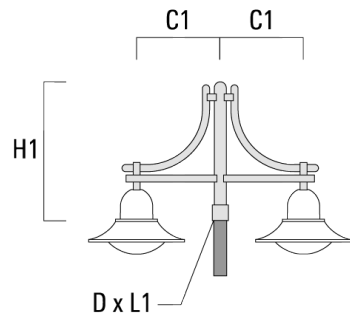

**BSP534 LED**

Description	Part ID	C1	C2	D × L1	H1	Weight (kg)	C	H
DB3-500 Pole bracket, triple	300-0192	510		76 x 80	700	10.30	510	700

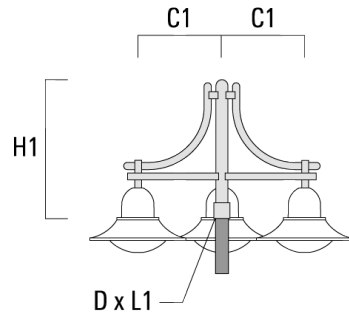

**Wall and pole brackets DS**

Description	Part ID	C1	C2	D × L1	H1	Weight (kg)	C	H
DS0-500 Wall bracket, single	300-0064	510	70		650	2.50	510	650

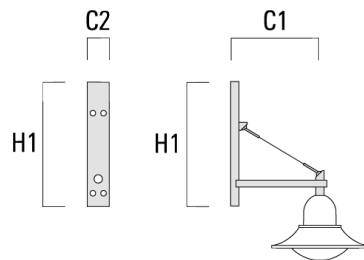

**BSP534 LED**

Description	Part ID	C1	C2	D x L1	H1	Weight (kg)	C	H
DS1-500 Pole bracket, single	300-0063	510		76 x 80	725	3.90	510	725

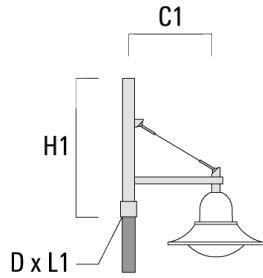

DS2-500 Pole bracket, double	300-0066	510		76 x 80	725	5.30	510	725
------------------------------	----------	-----	--	---------	-----	------	-----	-----

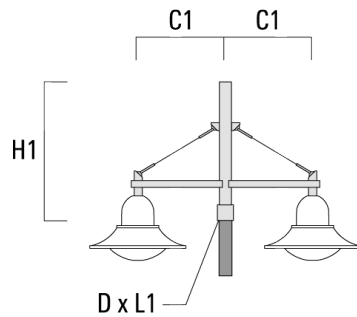

127-1270

BSP534 LED

**we-ef**

Description	Part ID	C1	C2	D x L1	H1	Weight (kg)	C	H
DS3-500 Pole bracket, triple	300-0069	510		76 x 80	725	6.70	510	725

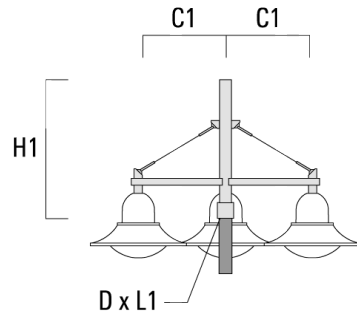

**127-1270**

**BSP534 LED**

**we-ef**

## **Optical Accessories**

### **Light shield**

Description	Part ID	Additional information
LS180	430-0029	Glare Shield for backlight spill. Glare Shield factory-installed or available as retrofit kit. Suitable for [S60], [S65], [S70], [R65], [P65] lenses. Must be specified at time of ordering.