



Description

IP55. Classe I. Classe II sur demande. IK10. Corps en fonte d'aluminium. Visserie inox avec traitement PCS. Protection contre la corrosion 5CE. Joint silicone. Modules LED interchangeables avec dissipateur de chaleur. Lentille PMMA avec technologie OLC® pour la maîtrise du flux et la précision de l'éclairage.

Version en 2200K disponible. À préciser lors de la demande de devis.

| | |
|----------------------------|---|
| Poids | 5.90 kg |
| Distribution de la lumière | [R65] Bi-asymétrique - parkings et voiries larges |
| Source lumineuse | LED-24/48W / 700 mA - 3000 K |
| IRC | 80 |
| Alimentation électrique | ballast électronique |
| LEDs | 24 |
| Rated input power | 54 W |

Flux lumineux nominal (lm)

| | |
|-------------|------|
| LED Lumen | 290 |
| Total Lumen | 6960 |
| Tj | 85 |

Rated lumens (lm)

| | |
|-------------|--------|
| LED Lumen | 225 |
| Total Lumen | 5398.9 |
| Ta | 25 |

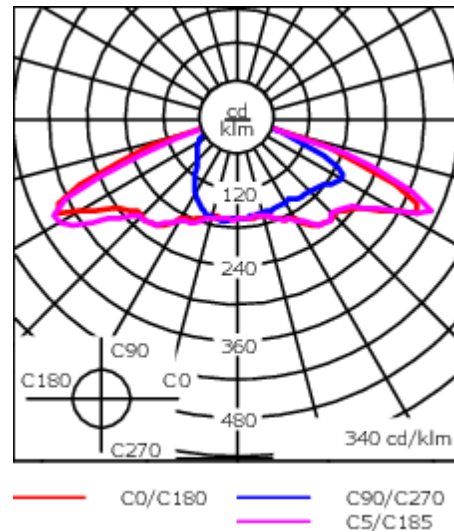
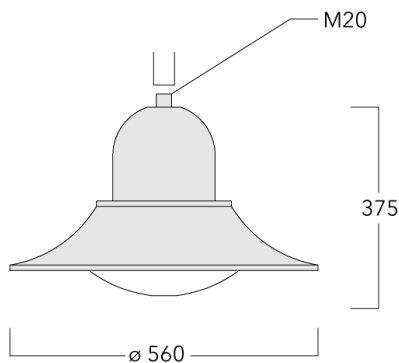

Spécifications

Description du matériel

| | |
|--------------------------------|--|
| Corps | Corps en fonte d'aluminium, visserie inox avec traitement PCS |
| Lentille | Lentille LED en PMMA, technologie OLC® - Vasque polycarbonate |
| Couleurs | <div style="display: flex; align-items: center;"> <div style="width: 20px; height: 10px; background-color: black; margin-right: 5px;"></div> RAL9004 Noir de sécurité </div> <div style="display: flex; align-items: center; margin-top: 5px;"> <div style="width: 20px; height: 10px; background-color: gray; margin-right: 5px;"></div> RAL9007 Aluminium gris </div> <div style="display: flex; align-items: center; margin-top: 5px;"> <div style="width: 20px; height: 10px; background-color: darkgray; margin-right: 5px;"></div> RAL7016 Gris anthracite </div> <div style="display: flex; align-items: center; margin-top: 5px;"> <div style="width: 20px; height: 10px; background-color: lightgray; margin-right: 5px;"></div> RAL9016 Blanc signalisation </div> |
| Joint | Joint silicone |
| Visserie | PCS Inox avec revêtement polymère |
| IP | IP55 |
| IK | IK10 |
| Protection contre la corrosion | 5CE |
| Surface exposée au vent | 0.0930m ² |

Description électrique

| | |
|-------------------------|---------------------------|
| Alimentation électrique | 220-240V / 50-60 Hz |
| Driver | Driver électronique. DALI |
| Power factor | > 0.9 |

WE-EF Switzerland AG

Himmelrichstrasse 6, 6003 Luzern - Téléphone: +41 22 752 49 94

info.switzerland@we-ef.com - https://we-ef.com/ch_fr

Sous réserve de modifications techniques et d'erreurs. - Généré le 23/11/2024

127-1274

BSP534 LED

we-ef

Informations complémentaires

Durée de vie Ta=25° L90B10 > 90000h

Classe d'efficacité
énergétique C-D

WE-EF Switzerland AG

Himmelrichstrasse 6, 6003 Luzern - Téléphone: +41 22 752 49 94

info.switzerland@we-ef.com - https://we-ef.com/ch_fr

Sous réserve de modifications techniques et d'erreurs. - Généré le 23/11/2024

127-1274

BSP534 LED

we-ef

Control

Eco Step Dim® Basic

| Description | Référence |
|-------------------------|-----------|
| Eco Step Dim® Basic LED | 430-0001 |

Eco Step Dim® Advanced

| Description | Référence |
|----------------------------|-----------|
| Eco Step Dim® Advanced LED | 430-0002 |

WE-EF Switzerland AG

Himmelrichstrasse 6, 6003 Luzern - Téléphone: +41 22 752 49 94

info.switzerland@we-ef.com - https://we-ef.com/ch_fr

Sous réserve de modifications techniques et d'erreurs. - Généré le 23/11/2024

Accessoires d'installation

Crosses murales et Crosses pour mât BA

| Description | Référence | C1 | D x L1 | H1 | H2 | M1 | Poids (kg) | C | H |
|-----------------------|-----------|-----|--------|------|-----|----|------------|-----|------|
| BA0-420 crosse murale | 300-0152 | 460 | | 1000 | 132 | 9 | 2 | 460 | 1000 |

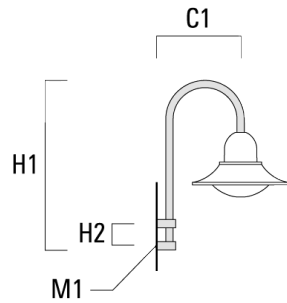

| | | | | | | | | | |
|-----------------------|----------|-----|---------|------|--|--|---|-----|------|
| BA1-420 crosse simple | 300-0099 | 420 | 76 x 80 | 1000 | | | 4 | 420 | 1000 |
|-----------------------|----------|-----|---------|------|--|--|---|-----|------|

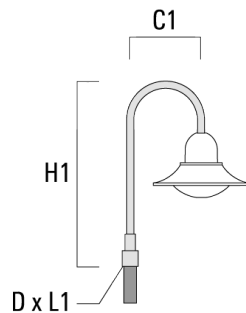

| Description | Référence | C1 | D x L1 | H1 | H2 | M1 | Poids (kg) | C | H |
|-----------------------|-----------|-----|---------|------|----|----|------------|-----|------|
| BA2-420 crosse double | 300-0104 | 500 | 76 x 80 | 1000 | | | 8 | 500 | 1000 |

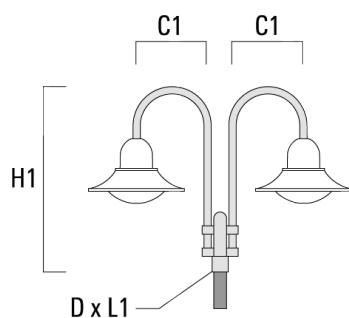

| | | | | | | | | | |
|-----------------------|----------|-----|---------|------|--|--|----|-----|------|
| BA3-420 crosse triple | 300-0109 | 500 | 76 x 80 | 1000 | | | 10 | 500 | 1000 |
|-----------------------|----------|-----|---------|------|--|--|----|-----|------|

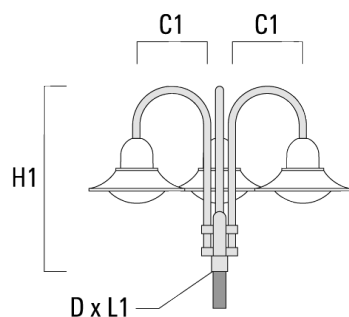

Crosses murales et Crosses pour mât BC

| Description | Référence | C1 | H1 | H2 | M1 | Poids (kg) | C | H |
|----------------------|-----------|-----|------|-----|----|------------|-----|------|
| BC0-420 crose murale | 300-0808 | 460 | 1230 | 300 | 8 | 2.30 | 460 | 1230 |

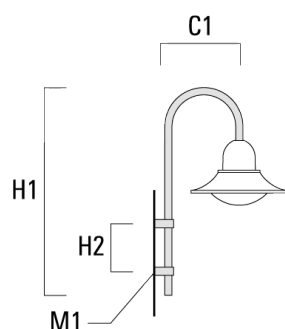

| | | | | | | | | |
|----------------------|----------|-----|------|-----|---|------|-----|------|
| BC1-420 crose simple | 300-0768 | 500 | 1230 | 300 | 8 | 2.30 | 500 | 1230 |
|----------------------|----------|-----|------|-----|---|------|-----|------|

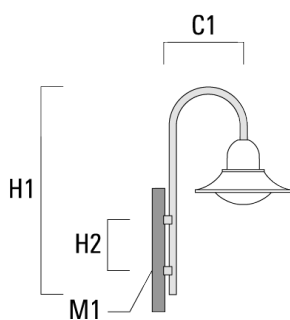

| Description | Référence | C1 | H1 | H2 | M1 | Poids (kg) | C | H |
|-----------------------|-----------|-----|------|-----|----|------------|-----|------|
| BC2-420 crosse double | 300-0767 | 500 | 1230 | 300 | 8 | 4.60 | 500 | 1230 |

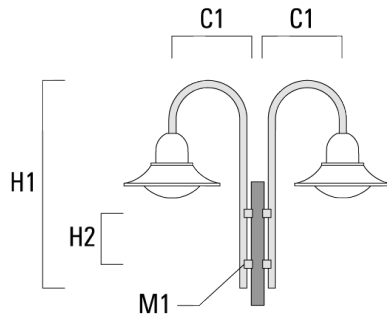

Crosses murales et Crosses pour mât DA

| Description | Référence | C1 | C2 | D × L1 | H1 | Poids (kg) | C | H |
|-----------------------|-----------|-----|----|--------|-----|------------|-----|-----|
| DA0-500 crosse murale | 300-0146 | 510 | 70 | | 650 | 5.70 | 510 | 650 |

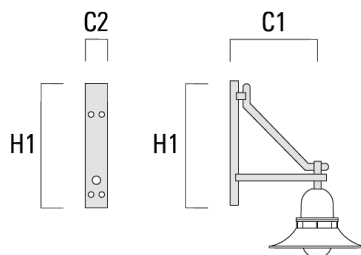

| Description | Référence | C1 | C2 | D x L1 | H1 | Poids (kg) | C | H |
|-----------------------|-----------|-----|----|---------|-----|------------|-----|-----|
| DA1-500 crosse simple | 300-0138 | 510 | | 76 x 80 | 700 | 5.70 | 510 | 700 |

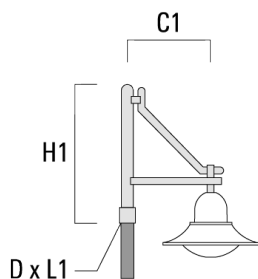

| | | | | | | | | |
|-----------------------|----------|-----|--|---------|-----|------|-----|-----|
| DA2-500 crosse double | 300-0141 | 510 | | 76 x 80 | 700 | 8.30 | 510 | 700 |
|-----------------------|----------|-----|--|---------|-----|------|-----|-----|

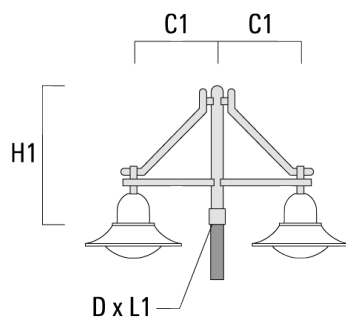

| Description | Référence | C1 | C2 | D × L1 | H1 | Poids (kg) | C | H |
|-----------------------|-----------|-----|----|---------|-----|------------|-----|-----|
| DA3-500 crosse triple | 300-0144 | 510 | | 76 x 80 | 700 | 10.90 | 510 | 700 |

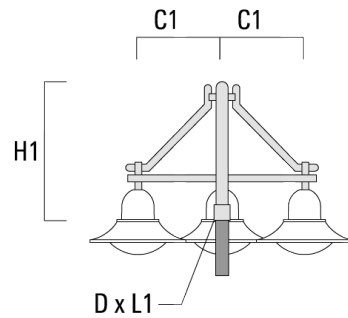

Crosses murales et Crosses pour mât DB

| Description | Référence | C1 | C2 | D × L1 | H1 | Poids (kg) | C | H |
|-----------------------|-----------|-----|----|--------|-----|------------|-----|-----|
| DB0-500 crosse murale | 300-0169 | 510 | 70 | | 650 | 5.50 | 510 | 650 |

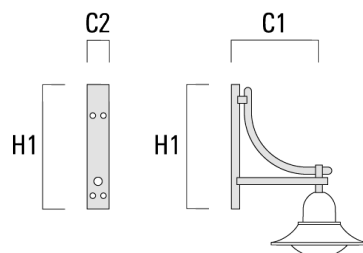

| Description | Référence | C1 | C2 | D x L1 | H1 | Poids (kg) | C | H |
|-----------------------|-----------|-----|----|---------|-----|------------|-----|-----|
| DB1-500 crosse single | 300-0190 | 510 | | 76 x 80 | 700 | 5.50 | 510 | 700 |

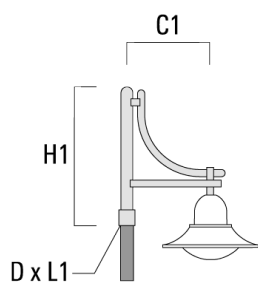

| | | | | | | | | |
|-----------------------|----------|-----|--|---------|-----|------|-----|-----|
| DB2-500 crosse double | 300-0191 | 510 | | 76 x 80 | 700 | 7.90 | 510 | 700 |
|-----------------------|----------|-----|--|---------|-----|------|-----|-----|

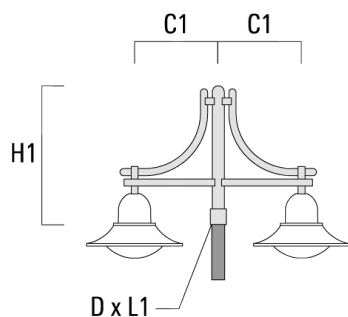

| Description | Référence | C1 | C2 | D × L1 | H1 | Poids (kg) | C | H |
|-----------------------|-----------|-----|----|---------|-----|------------|-----|-----|
| DB3-500 crosse triple | 300-0192 | 510 | | 76 x 80 | 700 | 10.30 | 510 | 700 |

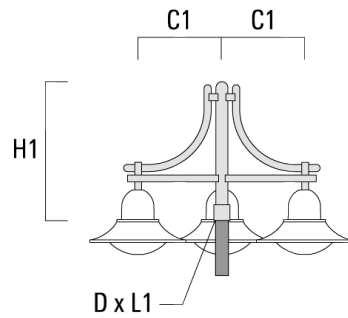

Crosses murales et Crosses pour mât DS

| Description | Référence | C1 | C2 | D × L1 | H1 | Poids (kg) | C | H |
|-----------------------|-----------|-----|----|--------|-----|------------|-----|-----|
| DS0-500 crosse murale | 300-0064 | 510 | 70 | | 650 | 2.50 | 510 | 650 |

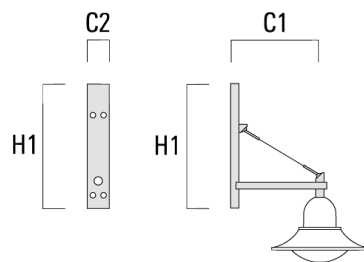

| Description | Référence | C1 | C2 | D x L1 | H1 | Poids (kg) | C | H |
|-----------------------|-----------|-----|----|---------|-----|------------|-----|-----|
| DS1-500 crosse simple | 300-0063 | 510 | | 76 x 80 | 725 | 3.90 | 510 | 725 |

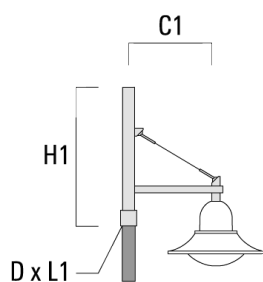

| | | | | | | | | |
|-----------------------|----------|-----|--|---------|-----|------|-----|-----|
| DS2-500 crosse double | 300-0066 | 510 | | 76 x 80 | 725 | 5.30 | 510 | 725 |
|-----------------------|----------|-----|--|---------|-----|------|-----|-----|

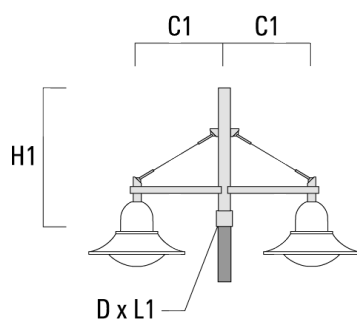

127-1274

BSP534 LED

we-ef

| Description | Référence | C1 | C2 | D x L1 | H1 | Poids (kg) | C | H |
|-----------------------|-----------|-----|----|---------|-----|------------|-----|-----|
| DS3-500 crosse triple | 300-0069 | 510 | | 76 x 80 | 725 | 6.70 | 510 | 725 |

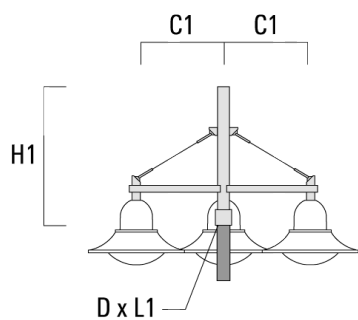

WE-EF Switzerland AG

Himmelrichstrasse 6, 6003 Luzern - Téléphone: +41 22 752 49 94

info.switzerland@we-ef.com - https://we-ef.com/ch_fr

Sous réserve de modifications techniques et d'erreurs. - Généré le 23/11/2024

Accessoires Optiques**Light shield**

| Description | Référence | Informations complémentaires |
|-------------|-----------|--|
| LS180 | 430-0029 | Coupe-flux arrière adapté pour les optiques [S60], [S65], [S70], [R65], [P65]. Coupe-flux arrière assemblé sur le luminaire en usine ou disponible pour le rétrofit. Cela doit être déterminé à la commande. |