

127-1275

BSP534 LED

**we-ef**



**Description**

IP55. Class I. IK10. Marine-grade, die-cast aluminum alloy. 5CE superior corrosion protection including PCS hardware. Silicone CCG® Controlled Compression Gasket. Polycarbonate main lens. CAD-optimized optics for superior illumination and glare control. Integral driver in thermally separated compartment. OLC® One LED Concept. Factory-installed LED circuit board.

Recommended mounting height 10-13 ft, depending on lamp type selected; brackets to be ordered separately.

Specify product with 7 Digit product code - Finish Color. Accessories, such as mounting, optical, and electrical, must be specified separately.

Example: XXX-XXXX-9004 (Black)  
+ XXX-XXXX (Accessory 1)

Weight	13.00 lb
Light distribution	[R65] Type IV Medium
Light source	LED-24/48W / 700 mA - 4000 K
CRI	80
Power supply	electronic gear
BUG	B2 U1 G1
LEDs	24
Rated input power	54 W

**Nominal Lumen (lm)**

LED Lumen	310
Total Lumen	7440
Tj	85

**Rated lumens (lm)**

LED Lumen	240.5
Total Lumen	5771.2
Ta	25

**WE-EF LIGHTING USA, LLC**

410-D Keystone Drive, 15086 Warrendale, PA 15086 - Phone: +1 724 742 0030  
customersupport.usa@we-ef.com - <https://we-ef.com/us>  
Subject to technical changes and errors. - Generated on 11/23/2024

**127-1275**  
**BSP534 LED**

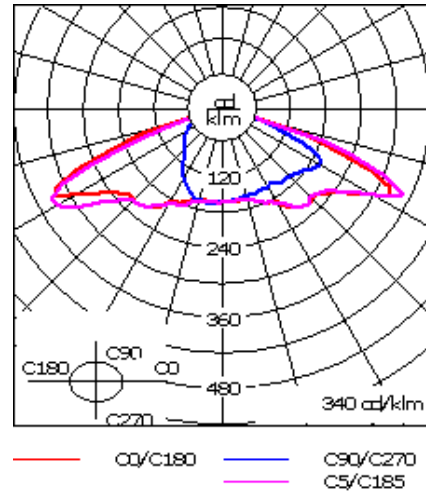
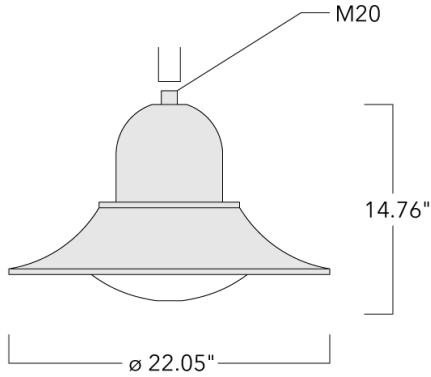

**Specifications**  
**Material description**

Body	Marine-grade die-cast aluminium alloy
Lens	Polycarbonate lens
Colors	<div style="display: flex; align-items: center; margin-bottom: 5px;"> <div style="width: 20px; height: 10px; background-color: black; margin-right: 5px;"></div> <span>RAL9004 Black</span> </div> <div style="display: flex; align-items: center; margin-bottom: 5px;"> <div style="width: 20px; height: 10px; background-color: grey; margin-right: 5px;"></div> <span>RAL9007 Grey Metallic</span> </div> <div style="display: flex; align-items: center; margin-bottom: 5px;"> <div style="width: 20px; height: 10px; background-color: white; margin-right: 5px;"></div> <span>RAL9016 White</span> </div> <div style="display: flex; align-items: center;"> <div style="width: 20px; height: 10px; background-color: darkgrey; margin-right: 5px;"></div> <span>RAL8019 Dark Bronze</span> </div>
Gasket	Silicone rubber gasket
Fasteners	PCS Polymer Coated Stainless Steel hardware
Ingress protection	IP55
Impact resistance	IK10
Corrosion resistance	5CE
Windage	1 ft <sup>2</sup>

**127-1275**

**BSP534 LED**

**we-ef**

**Electrical description**

---

Power supply	Integral [ECG] electronic driver 120V-277V. 0-10V dimmable, to be specified with order.
Driver / Ballast	Integral EC electronic converter
Power factor	> 0.9
Surge protection	Integral 10kV Surge Protector

---

**Additional information**

---

Lifetime	Ta=25°/40° L90B10 > 90000h
BUG Rating	Please see individual Spec Sheets for classification of Backlight, Uplight and Glare.
Listings	ETL, UL-1598, CSA-C22.2#250.0. Suitable for Wet Locations.

---

**WE-EF LIGHTING USA, LLC**

410-D Keystone Drive, 15086 Warrendale, PA 15086 - Phone: +1 724 742 0030

customersupport.usa@we-ef.com - <https://we-ef.com/us>

Subject to technical changes and errors. - Generated on 11/23/2024

**Mounting Accessories**

**Wall and pole brackets BA**

Description	Part ID	C1	D x L1	H1	H2	L	M1	Weight (lb)	C	H
BA0-420 Wall bracket, single	300-0152	18.11		39.37	5.2		0.35	4.41	460	1000

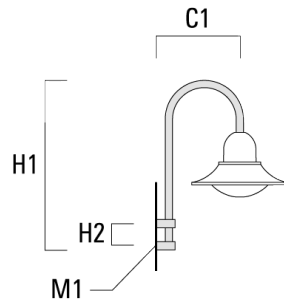

BA1-420 Pole bracket, single	300-0099	16.54	3 x 3	39.37		2.99		8.82	420	1000
------------------------------	----------	-------	-------	-------	--	------	--	------	-----	------

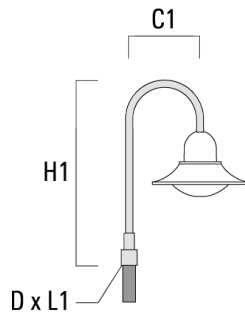

**BSP534 LED**

Description	Part ID	C1	D x L1	H1	H2	L	M1	Weight (lb)	C	H
BA2-420 Pole bracket, double	300-0104	19.69	3 x 3	39.37		2.99		17.64	500	1000

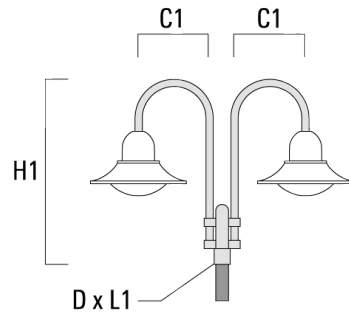

BA3-420 Pole bracket, triple	300-0109	19.69	3 x 3	39.37		2.99		22.05	500	1000
------------------------------	----------	-------	-------	-------	--	------	--	-------	-----	------

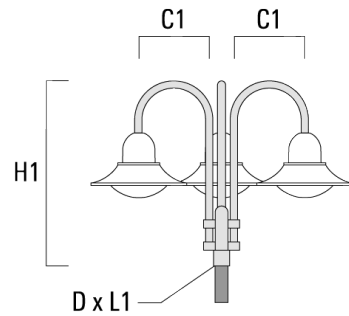

**WE-EF LIGHTING USA, LLC**

410-D Keystone Drive, 15086 Warrendale, PA 15086 - Phone: +1 724 742 0030  
 customersupport.usa@we-ef.com - <https://we-ef.com/us>

Subject to technical changes and errors. - Generated on 11/23/2024

**Wall and pole brackets BC**

Description	Part ID	C1	H1	H2	M1	Weight (lb)	C	H
BC0-420 Wall bracket, single	300-0808	460	1230	11.81	8	2.30	460	1230



BC1-420 Pole bracket, single	300-0768	500	1230	300	8	2.30	500	1230
------------------------------	----------	-----	------	-----	---	------	-----	------



**BSP534 LED**

Description	Part ID	C1	H1	H2	M1	Weight (lb)	C	H
BC2-420 Pole bracket, double	300-0767	500	1230	300	8	4.60	500	1230

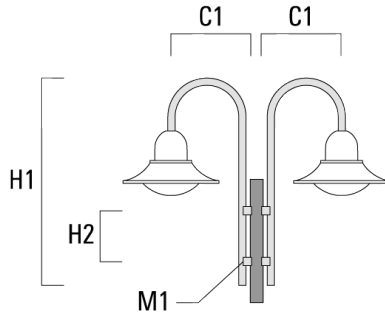

**Wall and pole brackets DA**

Description	Part ID	C1	C2	D × L1	H1	L	Weight (lb)	C	H
DA0-500 Wall bracket, single	300-0146	20.08	2.76		25.59		12.57	510	650

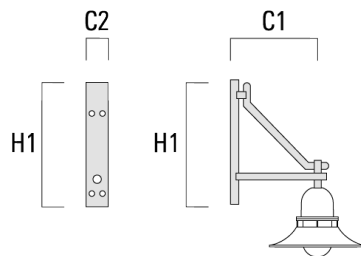

**WE-EF LIGHTING USA, LLC**

410-D Keystone Drive, 15086 Warrendale, PA 15086 - Phone: +1 724 742 0030

customersupport.usa@we-ef.com - <https://we-ef.com/us>

Subject to technical changes and errors. - Generated on 11/23/2024

**BSP534 LED**

Description	Part ID	C1	C2	D × L1	H1	L	Weight (lb)	C	H
DA1-500 Pole bracket, single	300-0138	20.08		3 x 3	27.56	2.99	12.57	510	700

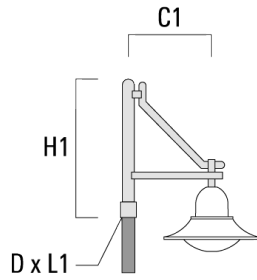

DA2-500 Pole bracket, double	300-0141	20.08		3 x 3	27.56	2.99	18.30	510	700
------------------------------	----------	-------	--	-------	-------	------	-------	-----	-----

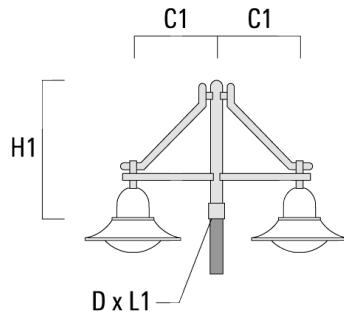

**WE-EF LIGHTING USA, LLC**

410-D Keystone Drive, 15086 Warrendale, PA 15086 - Phone: +1 724 742 0030  
 customersupport.usa@we-ef.com - <https://we-ef.com/us>

Subject to technical changes and errors. - Generated on 11/23/2024



**BSP534 LED**

Description	Part ID	C1	C2	D x L1	H1	L	Weight (lb)	C	H
DA3-500 Pole bracket, triple	300-0144	20.08		3 x 3	27.56	2.99	24.03	510	700

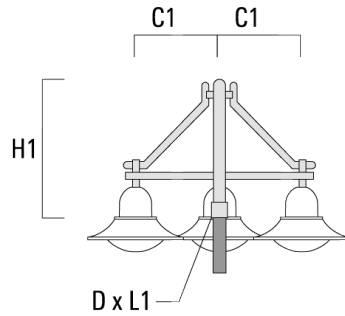

**Wall and pole brackets DB**

Description	Part ID	C1	C2	D x L1	H1	L	Weight (lb)	C	H
DB0-500 Wall bracket, single	300-0169	20.08	2.76		25.59		12.13	510	650

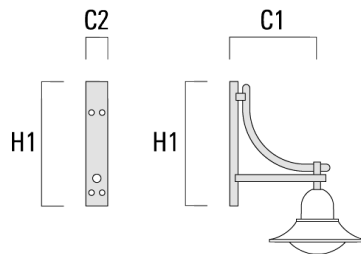

**WE-EF LIGHTING USA, LLC**

410-D Keystone Drive, 15086 Warrendale, PA 15086 - Phone: +1 724 742 0030  
 customersupport.usa@we-ef.com - <https://we-ef.com/us>  
 Subject to technical changes and errors. - Generated on 11/23/2024

127-1275

**we-ef**

**BSP534 LED**

Description	Part ID	C1	C2	D x L1	H1	L	Weight (lb)	C	H
DB1-500 Pole bracket, single	300-0190	20.08		3 x 3	27.56	2.99	12.13	510	700

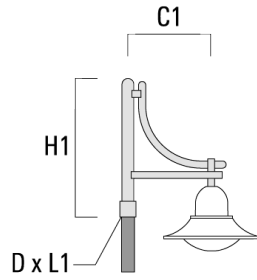

DB2-500 Pole bracket, double	300-0191	20.08		3 x 3	27.56	2.99	17.42	510	700
------------------------------	----------	-------	--	-------	-------	------	-------	-----	-----

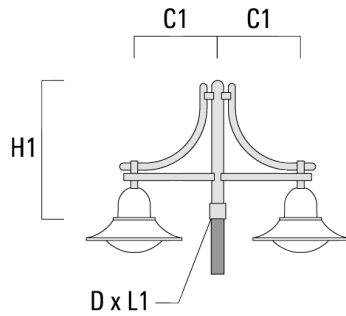

**WE-EF LIGHTING USA, LLC**

410-D Keystone Drive, 15086 Warrendale, PA 15086 - Phone: +1 724 742 0030  
customersupport.usa@we-ef.com - <https://we-ef.com/us>

Subject to technical changes and errors. - Generated on 11/23/2024

**BSP534 LED**

Description	Part ID	C1	C2	D × L1	H1	L	Weight (lb)	C	H
DB3-500 Pole bracket, triple	300-0192	20.08		3 x 3	27.56	2.99	22.71	510	700

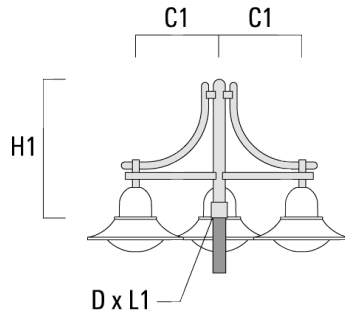

**Wall and pole brackets DS**

Description	Part ID	C1	C2	D × L1	H1	L	Weight (lb)	C	H
DS0-500 Wall bracket, single	300-0064	20.08	2.76		25.59		5.51	510	650

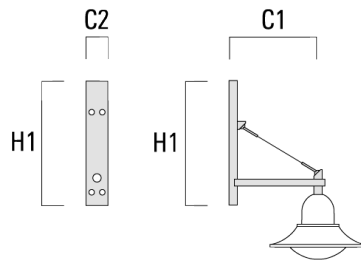

**WE-EF LIGHTING USA, LLC**

410-D Keystone Drive, 15086 Warrendale, PA 15086 - Phone: +1 724 742 0030

customersupport.usa@we-ef.com - <https://we-ef.com/us>

Subject to technical changes and errors. - Generated on 11/23/2024

**BSP534 LED**

Description	Part ID	C1	C2	D x L1	H1	L	Weight (lb)	C	H
DS1-500 Pole bracket, single	300-0063	20.08		3 x 3	28.54	2.99	8.60	510	725



DS2-500 Pole bracket, double	300-0066	20.08		3 x 3	28.54	2.99	11.68	510	725
------------------------------	----------	-------	--	-------	-------	------	-------	-----	-----



**WE-EF LIGHTING USA, LLC**

410-D Keystone Drive, 15086 Warrendale, PA 15086 - Phone: +1 724 742 0030  
 customersupport.usa@we-ef.com - <https://we-ef.com/us>

Subject to technical changes and errors. - Generated on 11/23/2024

127-1275

BSP534 LED

**we-ef**

Description	Part ID	C1	C2	D x L1	H1	L	Weight (lb)	C	H
DS3-500 Pole bracket, triple	300-0069	20.08		3 x 3	28.54	2.99	14.77	510	725

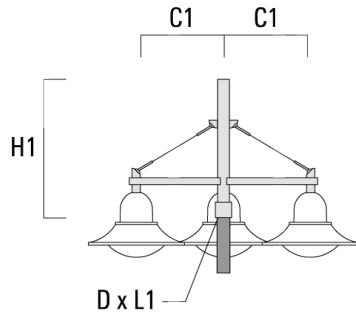

**WE-EF LIGHTING USA, LLC**

410-D Keystone Drive, 15086 Warrendale, PA 15086 - Phone: +1 724 742 0030  
customersupport.usa@we-ef.com - <https://we-ef.com/us>

Subject to technical changes and errors. - Generated on 11/23/2024

**127-1275**

**BSP534 LED**

**we-ef**

## **Optical Accessories**

### **Light shield**

Description	Part ID	Additional information
LS180	430-0029	Glare Shield for backlight spill. Glare Shield factory-installed or available as retrofit kit. Suitable for [S60], [S65], [S70], [R65], [P65] lenses. Must be specified at time of ordering.

**WE-EF LIGHTING USA, LLC**

410-D Keystone Drive, 15086 Warrendale, PA 15086 - Phone: +1 724 742 0030  
customersupport.usa@we-ef.com - <https://we-ef.com/us>

Subject to technical changes and errors. - Generated on 11/23/2024