

102-0837

AFL120-R2S

**we-ef**



### Description

R2S. IP66, Class III. IK08. Marine-grade, die-cast aluminium alloy. 5CE superior corrosion protection including PCS hardware. CCG® Controlled Compression Gasket. Non-reflective flat safety glass cover, hinged. Integral LED driver. The luminaire only has one input for the 24V DC supply voltage. Controls or sensors are not included and must be ordered separately depending on the solar system selected. CAD-optimised optics for superior illumination and glare control. OLC® One LED Concept. Factory installed LED circuit board. The luminaire is factory-sealed and does not need to be opened during installation. Can be used as post top or side entry version. Specification at time of order is recommended.

Spigot Ø 76 x 100 mm. Spigot Ø 60 x 100 mm or 42 x 100 mm option available. Must be indicated during order placement.

Contact WE-EF direct or your local WE-EF sales representative for an individual solution designed to precisely meet your needs.

Photometric files (IES, LDT) for light distributions [A61] [P66] with Backlight Shield on request.

Weight	7.00 kg
Light distribution	pedestrian/bicycle lane [P66]
Light source	LED-24/24W / 350mA - Amber
CRI	NA
Power supply	EC
LEDs	24
Rated input power	20 W

### Nominal Lumen (lm)

LED Lumen	40
Total Lumen	960
Tj	25

### Rated lumens (lm)

LED Lumen	35.2
Total Lumen	844
Ta	25

### WE-EF LIGHTING Pty Ltd

47 Tarnard Drive, 3195 Braeside, Victoria - Phone: +61 3 8587 0444 - Fax: +61 3 8587 0499

info.australia@we-ef.com - <https://we-ef.com/aus>

Subject to technical changes and errors. - Generated on 19/04/2025

102-0837

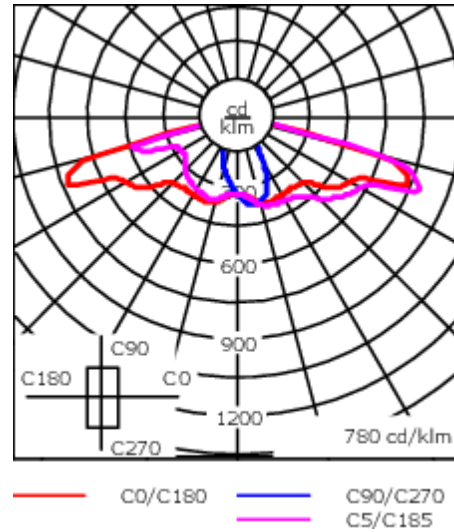
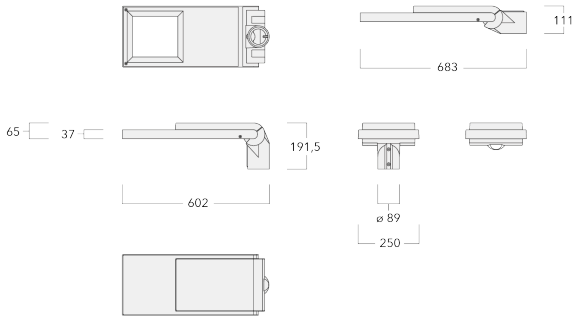

AFL120-R2S

**we-ef**



## Specifications

### Material description

Body	Marine-grade, die-cast aluminium alloy
Lens	Non-reflective safety glass lens
Colours	 RAL9004 Signal black  RAL9006 White aluminium  RAL9007 Grey aluminium
Gasket	CCG® Controlled Compression Gasket
Fasteners	PCS Polymer Coated Stainless Steel Hardware
Ingress protection	IP66
Impact resistance	IK08
Corrosion resistance	5CE+Primer
Windage	0.146 m <sup>2</sup>

### Electrical description

Power supply	24V DC (0 HZ) battery voltage
Driver / Ballast	PWM. DALI and analogue dimming on request
Surge protection	75-100V automatic recovery

### Additional information

Lifetime	Ta=40° L90B10 > 90000h
----------	------------------------

#### WE-EF LIGHTING Pty Ltd

47 Tarnard Drive, 3195 Braeside, Victoria - Phone: +61 3 8587 0444 - Fax: +61 3 8587 0499

info.australia@we-ef.com - <https://we-ef.com/aus>

Subject to technical changes and errors. - Generated on 19/04/2025

**102-0837**

**AFL120-R2S**

**we-ef**

## Optical Accessories

### Backlight shield

Description	Part ID	Additional information
Backlight shield LS180	102-0959-24LED	Glare Shield for backlight spill. Suitable for [S65] [R60] lenses. Glare Shield factory-installed or available as retrofit kit. Must be specified at time of ordering.



**WE-EF LIGHTING Pty Ltd**

47 Tarnard Drive, 3195 Braeside, Victoria - Phone: +61 3 8587 0444 - Fax: +61 3 8587 0499

info.australia@we-ef.com - <https://we-ef.com/aus>

Subject to technical changes and errors. - Generated on 19/04/2025

**102-0837**

**AFL120-R2S**

**we-ef**

## Mounting Accessories

### Bird deterrent

---

Description	Part ID
Bird deterrent BD	430-0015

---



---

### Adaptor

---

Description	Part ID
Adaptor AFL100	102-0392

---



---

#### **WE-EF LIGHTING Pty Ltd**

47 Tarnard Drive, 3195 Braeside, Victoria - Phone: +61 3 8587 0444 - Fax: +61 3 8587 0499

info.australia@we-ef.com - <https://we-ef.com/aus>

Subject to technical changes and errors. - Generated on 19/04/2025