

102-0843

AFL120-R2S

we-ef



### Description

R2S. IP66, Class III. IK08. Marine-grade, die-cast aluminium alloy. 5CE superior corrosion protection including PCS hardware. CCG® Controlled Compression Gasket. Non-reflective flat safety glass cover, hinged. Integral LED driver, PMW interface (DALI, analogue dimming interface on request). The luminaire only has one input for the 24V DC supply voltage. Controls or sensors are not included and must be ordered separately depending on the solar system selected. CAD-optimised optics for superior illumination and glare control. OLC® One LED Concept. Factory installed LED circuit board (Zhaga Book 15 compliant). The luminaire is factory-sealed and does not need to be opened during installation. Can be used as post top or side entry version. Specification at time of order is recommended.

Spigot Ø 76 x 100 mm. Spigot Ø 60 x 100 mm or 42 x 100 mm option available. Must be indicated during order placement.

Contact WE-EF direct or your local WE-EF sales representative for an individual solution designed to precisely meet your needs.

Photometric files (IES, LDT) for light distributions [S70] [R60] [A61] [P66] with Backlight Shield on request.

### WE-EF LIGHTING (Thailand) Co., Ltd.

57 Moo 5, Kingkaew Rd., Bangplee, 10540 Samutprakarn - Phone: +66 2 738 96 20 - Fax: +66 2 738 96 29

<https://we-ef.com/asia>

Subject to technical changes and errors. - Generated on 23/10/2024

Weight	7.00 kg
Light distribution	rectangular, side throw [R60]
Light source	LED-24/36W / 500 mA - 2700K
CRI	80
Power supply	EC
LEDs	24
Rated input power	39 W

### Nominal Lumen (lm)

LED Lumen	200
Total Lumen	4800
Tj	85

### Rated lumens (lm)

LED Lumen	182.3
Total Lumen	4375.7
Ta	25

**102-0843**

**AFL120-R2S**

**we-ef**

\*\*\* IMPORTANT: Solar Panel not included (Third party supply) \*\*\*

**WE-EF LIGHTING (Thailand) Co., Ltd.**

57 Moo 5, Kingkaew Rd., Bangplee, 10540 Samutprakarn - Phone: +66 2 738 96 20 - Fax: +66 2 738 96 29

<https://we-ef.com/asia>

Subject to technical changes and errors. - Generated on 23/10/2024

2 of 5

102-0843



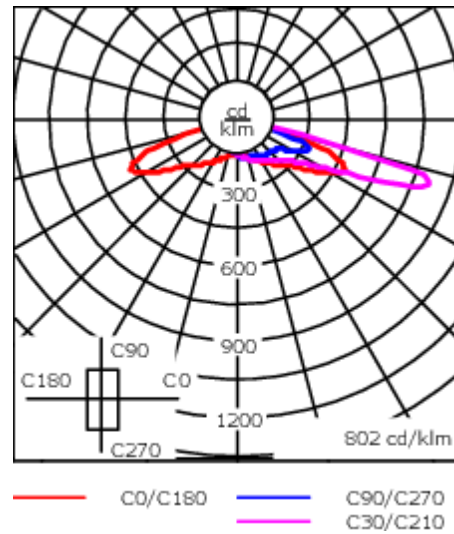
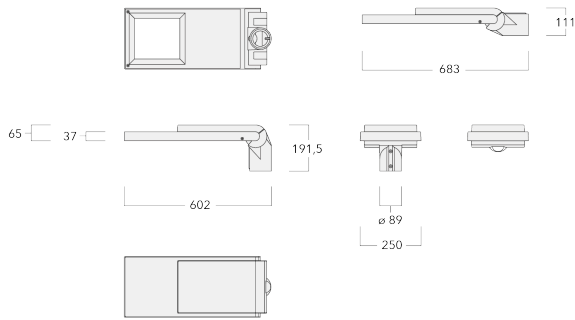

AFL120-R2S

**we-ef**



## Specifications

### Material description

Body	Marine-grade, die-cast aluminium alloy
Lens	Non-reflective safety glass lens
Colours	 RAL9004 Signal black  RAL9007 Grey aluminium  RAL7016 Anthracite grey  RAL9016 Traffic white
Gasket	CCG® Controlled Compression Gasket
Fasteners	PCS Polymer Coated Stainless Steel Hardware
Ingress protection	IP66
Impact resistance	IK08
Corrosion resistance	5CE
Windage	0.146 m <sup>2</sup>

### Electrical description

Power supply	24V DC (0 HZ) battery voltage
Driver / Ballast	PWM. DALI and analogue dimming on request
Surge protection	75-100V automatic recovery

### Additional information

Lifetime	Ta=25° L90B10 > 90000h
----------	------------------------

**WE-EF LIGHTING (Thailand) Co., Ltd.**

57 Moo 5, Kingkaew Rd., Bangplee, 10540 Samutprakarn - Phone: +66 2 738 96 20 - Fax: +66 2 738 96 29

<https://we-ef.com/asia>

Subject to technical changes and errors. - Generated on 23/10/2024

## Optical Accessories

### Backlight shield

Description	Part ID	Additional information
Backlight shield LS180	102-0959-24LED	Glare Shield for backlight spill. Suitable for [S65] [R60] lenses. Glare Shield factory-installed or available as retrofit kit. Must be specified at time of ordering.

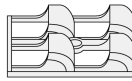

Backlight shield LS180	102-0395-24LED	Glare Shield for backlight spill. Suitable for [S61], [S66], [R61], [P66] [Q66], [A61] lenses. Glare Shield factory-installed or available as retrofit kit. Must be specified at time of ordering.
------------------------	----------------	---

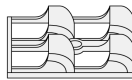

**102-0843**

**AFL120-R2S**

**we-ef**

## Mounting Accessories

### Bird deterrent

---

Description	Part ID
Bird deterrent BD	430-0015

---

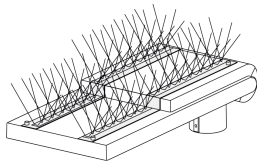

---

### Adaptor

---

Description	Part ID
Adaptor AFL100	102-0392

---

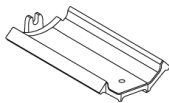

---

**WE-EF LIGHTING (Thailand) Co., Ltd.**

57 Moo 5, Kingkaew Rd., Bangplee, 10540 Samutprakarn - Phone: +66 2 738 96 20 - Fax: +66 2 738 96 29

<https://we-ef.com/asia>

Subject to technical changes and errors. - Generated on 23/10/2024

**102-0843**

**AFL120-R2S**

**WE-EF LIGHTING (Thailand) Co., Ltd.**

57 Moo 5, Kingkaew Rd., Bangplee, 10540 Samutprakarn

Phone: +66 2 738 96 20

Fax: +66 2 738 96 29

<https://we-ef.com/asia>

Subject to technical changes and errors.

Generated on 23/10/2024