



Beschreibung

Projektor [FP] zur konturgenauen Ausleuchtung polygoner Flächen. Sphärisches / dreifaches Plankonvexlinsensystem zur Erzeugung eines parallelen Lichtbündels.

IP66, SKI. SKII auf Anfrage. IK07. Korrosionsbeständiger Aluminiumguss. PCS beschichtete Edelstahlschrauben. 5CE Korrosionsschutz. CCG® Silikondichtung. Sicherheitsglas. Eine Kabelverschraubung, eine zweite Kabelverschraubung zur Durchverdrahtung auf Anfrage. PMMA LED Linse. Eingebaute LED Platine, austauschbar. Eingebaute elektronische Betriebsgeräte, thermisch getrennt. Variante mit 2200 K bis max. 1050 mA erhältlich, bei Bestellung bitte angeben.

| | |
|--------------------|--|
| Gewicht | 10.80 kg |
| Lichtverteilung | symmetrisch Framing-Projector [FP] - min. Öffnungswinkel |
| Lichtquelle | LED-FT-48W / 1100 mA - 2700 K |
| CRI | 80 |
| Netz | EVG |
| LEDs | 1 |
| Bemessungsleistung | 53 W |

Bemessungslichtstrom (lm)

| | |
|-------------|--------|
| LED Lumen | 3684.7 |
| Total Lumen | 3684.7 |
| Ta | 25 |

Nominal Lichtstrom (lm)

| | |
|-------------|------|
| LED Lumen | 6435 |
| Total Lumen | 6435 |
| Tc | 25 |

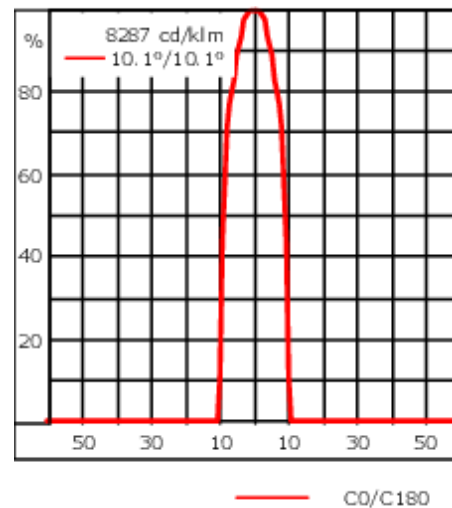

Spezifikationen

Materialbeschreibung

| | |
|-------------------------|---|
| Gehäuse | Korrosionsbeständiger Aluminiumguss |
| Abdeckung | Sicherheitsglasscheibe |
| Farben | <div style="display: flex; flex-direction: column; gap: 5px;"> <div> RAL9004 Signalschwarz</div> <div> RAL9006 Weißaluminium</div> <div> RAL9007 Graualuminium</div> <div> RAL7016 Anthrazitgrau</div> <div> RAL9016 Verkehrsweiß</div> </div> |
| Dichtung | CCG® Silikondichtung |
| Schrauben | PCS beschichtete Edelstahlschrauben |
| Schutzart | IP66 |
| Schlagfestigkeit | IK07 |
| Korrosionsbeständigkeit | 5CE |
| Windangriffsfläche | 0.114 m ² |

Elektrische Beschreibung

| | |
|-------------------------------|---|
| Netz | 220-240V / 50-60 Hz |
| Netzgerät / Vorschaltgerät | Standard. Variante mit DALI erhältlich, bei Bestellung bitte angeben. |
| Leistungsfaktor | > 0,9 |
| Überspannungsschutz | 6/6 kV (optional SP10) |

WE-EF LEUCHTEN GmbH

Töpinger Straße 16, 29646 Bispingen, Germany - Tel: +49 5194 909-0
 info.germany@we-ef.com - <https://we-ef.com/de>

Technische Änderungen und Irrtümer vorbehalten. - Erstellt am 23.11.2024

139-3002_min

FLC230 LED [FP]

we-ef

Weitere Informationen

Lebensdauer Ta=25° L70B50 > 50000h

Energieeffizienzklasse C-D (Lichtquelle)

WE-EF LEUCHTEN GmbH

Töpinger Straße 16, 29646 Bispingen, Germany - Tel: +49 5194 909-0

info.germany@we-ef.com - <https://we-ef.com/de>

Technische Änderungen und Irrtümer vorbehalten. - Erstellt am 23.11.2024

Montagezubehör

Montagesockel EM

| Beschreibung | Artikelnummer | D1 | D2 | H1 | M1 | Gewicht (kg) |
|--------------|---------------|-----|-----|-----|----|--------------|
| EM1-M16 | 270-9038 | 160 | 130 | 200 | 9 | 2 |



Mastaufsatztraverse TA

| Beschreibung | Artikelnummer | A | C1 | D x L1 | Gewicht (kg) | D x S |
|--|---------------|---|-----|----------|--------------|----------|
| TA1 Mastaufsatztraverse, einfach* (Ø 76 x 200) | 147-0023 | | 130 | 76 x 200 | 1.90 | 76 x 200 |



| Beschreibung | Artikelnummer | A | C1 | D × L1 | Gewicht (kg) | D × S |
|--|---------------|---|-----|-----------|--------------|-----------|
| TA1 Mastaufsatztraverse, einfach (Ø 108 x 200) | 147-0096 | | 130 | 108 x 200 | 7.50 | 108 x 200 |



| | | | | | | |
|--|----------|--|-----|----------|------|----------|
| TA2 Mastaufsatztraverse, zweifach (Ø 76 x 200) | 147-0024 | | 130 | 76 x 200 | 1.90 | 76 x 200 |
|--|----------|--|-----|----------|------|----------|



FLC230 LED [FP]

| Beschreibung | Artikelnummer | A | C1 | D × L1 | Gewicht (kg) | D × S |
|---|---------------|---|-----|-----------|--------------|-----------|
| TA2 Mastaufsatztraverse, zweifach (Ø 108 x 200) | 147-0097 | | 130 | 108 x 200 | 7.50 | 108 x 200 |

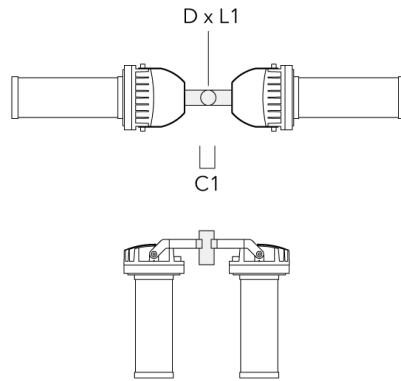

| | | | | | | |
|---|----------|------|-----|-----------|-------|-----------|
| TA2-L Mastaufsatztraverse, zweifach (Ø 108 x 200) | 147-0148 | ±90° | 420 | 108 x 200 | 20.20 | 108 x 200 |
|---|----------|------|-----|-----------|-------|-----------|



FLC230 LED [FP]

| Beschreibung | Artikelnummer | A | C1 | D x L1 | Gewicht (kg) | D x S |
|---|---------------|------|-----|----------|--------------|----------|
| TA2-L Mastaufsatztraverse, zweifach (Ø 76 x 200) | 147-0105 | ±90° | 420 | 76 x 200 | 16.10 | 76 x 200 |



| | | | | | | |
|--|----------|------|-----|----------|-------|----------|
| TA3 Mastaufsatztraverse, dreifach (Ø 89 x 200) | 147-0025 | ±90° | 650 | 89 x 200 | 17.90 | 89 x 200 |
|--|----------|------|-----|----------|-------|----------|



| Beschreibung | Artikelnummer | A | C1 | D x L1 | Gewicht (kg) | D x S |
|---|---------------|------|-----|-----------|--------------|-----------|
| TA3 Mastaufsatztraverse, dreifach (Ø 108 x 200) | 147-0098 | ±90° | 650 | 108 x 200 | 24.20 | 108 x 200 |



| | | | | | | |
|--|----------|------|-----|----------|-------|----------|
| TA4 Mastaufsatztraverse, vierfach (Ø 89 x 200) | 147-0099 | ±90° | 650 | 89 x 200 | 20.80 | 89 x 200 |
|--|----------|------|-----|----------|-------|----------|



FLC230 LED [FP]

| Beschreibung | Artikelnummer | A | C1 | D × L1 | Gewicht (kg) | D × S |
|---|---------------|------|-----|-----------|--------------|-----------|
| TA4 Mastaufsatztraverse, vierfach (Ø 108 x 200) | 147-0100 | ±90° | 650 | 108 x 200 | 24.20 | 108 x 200 |



Mastschelle TS

| Beschreibung | Artikelnummer | D1 | Gewicht (kg) | D |
|--|---------------|---------|--------------|---------|
| TS1-2/M12 Mastschelle, einfach (Ø 102-114) | 147-0526 | 102-114 | 1.50 | 102-114 |



FLC230 LED [FP]

| Beschreibung | Artikelnummer | D1 | Gewicht (kg) | D |
|--|---------------|---------|--------------|---------|
| TS1-2/M12 Mastschelle, einfach (Ø 114-133) | 147-0544 | 114-133 | 1.70 | 114-133 |

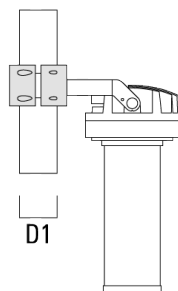
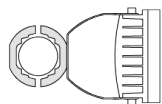

| | | | | |
|---|----------|---------|------|---------|
| TS2-2/M12 Mastschelle, zweifach (Ø 102-114) | 147-0527 | 102-114 | 1.50 | 102-114 |
|---|----------|---------|------|---------|

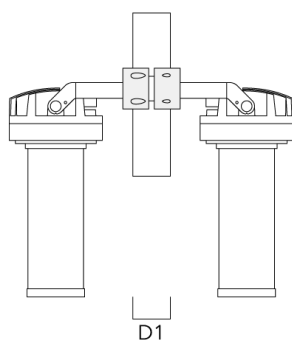
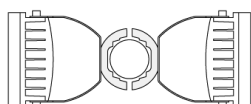

| Beschreibung | Artikelnummer | D1 | Gewicht (kg) | D |
|---|---------------|-------|--------------|-------|
| TS2-2/M12 Mastschelle, zweifach (Ø 76-89) | 147-0545 | 76-89 | 1.40 | 76-89 |

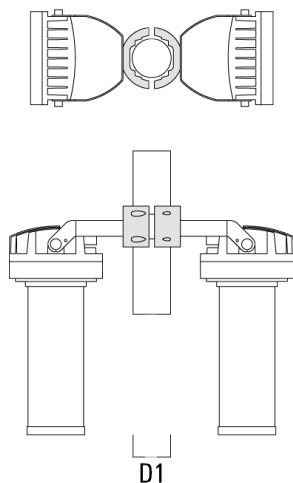

| | | | | |
|---|----------|---------|------|---------|
| TS2-2/M12 Mastschelle, zweifach (Ø 114-133) | 147-0546 | 114-133 | 1.60 | 114-133 |
|---|----------|---------|------|---------|

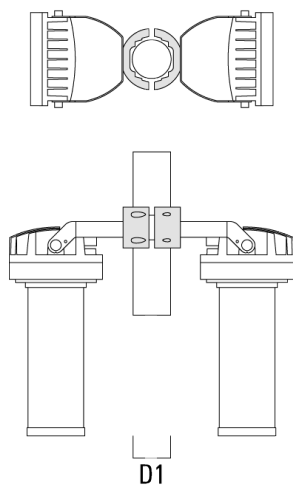

FLC230 LED [FP]

| Beschreibung | Artikelnummer | D1 | Gewicht (kg) | D |
|--|---------------|-------|--------------|-------|
| TS1-2/M12 Mastschelle, einfach (Ø 76-89) | 147-0543 | 76-89 | 1.40 | 76-89 |

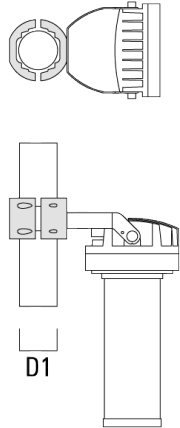

Erdstück

| Beschreibung | Artikelnummer | D1 | D2 | D3 | D4 | H1 | H2 | M1 | Gewicht (kg) |
|---------------|---------------|-----|-----|----|----|-----|-----|----|--------------|
| Erdstück ESV4 | 300-0461 | 145 | 130 | 60 | 89 | 400 | 350 | 8 | 3.83 |



Mastschelle PC

| Beschreibung | Artikelnummer | D1 | Gewicht (kg) |
|---|---------------|-------|--------------|
| PC1 76-89/60 Mastschelle, einfach (Ø 76-89) | 139-2702 | 76-89 | 1.00 |

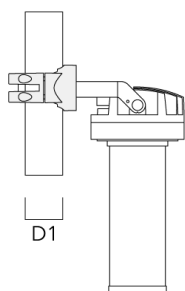
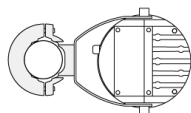

| | | | |
|--|----------|-------|------|
| PC2 76-89/60 Mastschelle, zweifach (Ø 76-89) | 139-2703 | 76-89 | 1.00 |
|--|----------|-------|------|

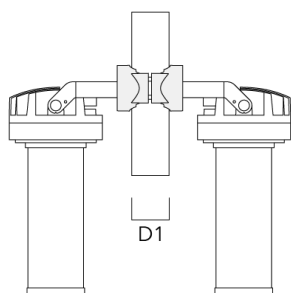
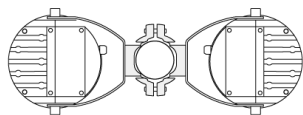

FLC230 LED [FP]

| Beschreibung | Artikelnummer | D1 | Gewicht (kg) |
|--|---------------|--------|--------------|
| PC1 82-109/60 Mastschelle, einfach (Ø 82-109) | 139-2704 | 82-109 | 1.10 |



| | | | |
|---|----------|--------|------|
| PC2 82-109/60 Mastschelle, zweifach (Ø 82-109) | 139-2705 | 82-109 | 1.10 |
|---|----------|--------|------|



FLC230 LED [FP]

| Beschreibung | Artikelnummer | D1 | Gewicht (kg) |
|---|---------------|---------|--------------|
| PC1 102-114/60 Mast­schelle, einfach (Ø 102-114) | 139-2706 | 102-114 | 1.20 |



| | | | |
|--|----------|---------|------|
| PC2 102-114/60 Mast­schelle, zweifach (Ø 102-114) | 139-2707 | 102-114 | 1.20 |
|--|----------|---------|------|



FLC230 LED [FP]

| Beschreibung | Artikelnummer | D1 | Gewicht (kg) |
|--|---------------|---------|--------------|
| PC1 114-133/60 Mastschelle, einfach (Ø 144-133) | 139-2708 | 114-133 | 1.40 |

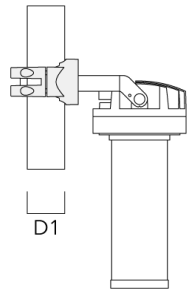
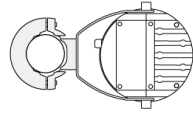

| | | | |
|---|----------|---------|------|
| PC2 114-133/60 Mastschelle, zweifach (Ø 114-133) | 139-2709 | 114-133 | 1.40 |
|---|----------|---------|------|



Steuerung**Eco Step Dim® Basic**

| Beschreibung | Artikelnummer |
|-------------------------|---------------|
| Eco Step Dim® Basic LED | 430-0001 |

Eco Step Dim® Advanced

| Beschreibung | Artikelnummer |
|----------------------------|---------------|
| Eco Step Dim® Advanced LED | 430-0002 |

R2C Ready to Connect

| Beschreibung | Artikelnummer |
|-----------------------------|---------------|
| R2C Ready to Connect (oben) | 430-0019 |