



Description

Profile Projector [FP] for framing applications, polygon shape. Spherical/triple flat convex lens system.

IP66, Class I. Class II on request. IK07. Marine-grade, die-cast aluminium alloy. 5CE superior corrosion protection including PCS hardware. Silicone CCG® Controlled Compression Gasket. Safety glass lens. One cable gland. Second gland for through wiring on request. PMMA LED lens array. Factory installed LED circuit board. LED board can be removed for upgrading. Integral EC electronic converter, thermally separated.

Optional 2200 K version up to max. 1050mA available. To be specified at time of ordering.

Weight	10.80 kg
Light distribution	symmetric Framing-Projector [FP] - max aperture angle
Light source	LED-FT-48W / 1100 mA - 3000 K
CRI	80
Power supply	EC
LEDs	1
Rated input power	53 W

Rated lumens (lm)

LED Lumen	3325
Total Lumen	3325
Ta	25

Nominal Lumen (lm)

LED Lumen	6495
Total Lumen	6495
Tc	25

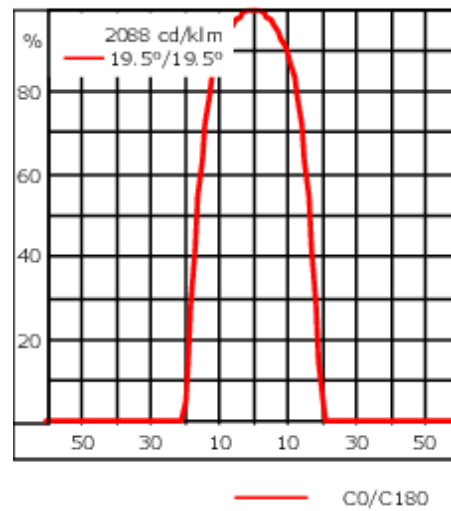

Specifications

Material description

Body	Marine-grade, die-cast aluminium alloy
Lens	Safety glass lens
Colours	<ul style="list-style-type: none"> RAL9004 Signal black RAL9006 White aluminium RAL9007 Grey aluminium RAL7016 Anthracite grey RAL9016 Traffic white
Gasket	Silicone CCG® Controlled Compression Gasket
Fasteners	PCS Polymer Coated Stainless Steel Hardware
Ingress protection	IP66
Impact resistance	IK07
Corrosion resistance	5CE
Windage	0.114 m ²

Electrical description

Power supply	220-240V / 50-60 Hz
Driver / Ballast	Standard. Optional DALI version available. To be specified at time of ordering.
Power factor	> 0.9
Surge protection	6/6 kV (optional SP10)

139-3004_max

FLC230 LED [FP]

we-ef

Additional information

Lifetime Ta=25° L70B50 > 50000h

Energy efficiency class C-D (Light source)

Fagerhult Lighting Ltd

33-34 Dolben Street, SE1 0UQ London, United Kingdom

<https://we-ef.com/uk>

Subject to technical changes and errors. - Generated on 23/10/2024

Mounting Accessories

Short post EM

Description	Part ID	D1	D2	H1	M1	Weight (kg)
EM1-M16	270-9038	160	130	200	9	2



Floodlight mounting bracket TA

Description	Part ID	A	C1	D x L1	Weight (kg)	D x S
TA1 Mounting bracket, single* (Ø 76 x 200)	147-0023		130	76 x 200	1.90	76 x 200



FLC230 LED [FP]

Description	Part ID	A	C1	D × L1	Weight (kg)	D × S
TA1 Mounting bracket, single (Ø 108 x 200)	147-0096		130	108 x 200	7.50	108 x 200



TA2 Mounting bracket, double* (Ø 76 x 200)	147-0024		130	76 x 200	1.90	76 x 200
--	----------	--	-----	----------	------	----------

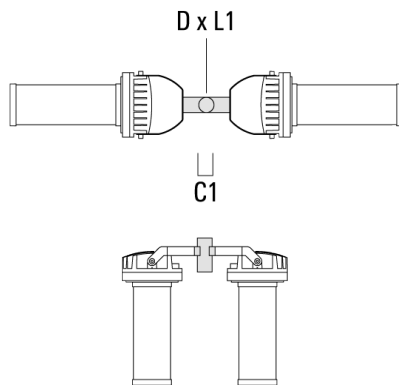

FLC230 LED [FP]

Description	Part ID	A	C1	D x L1	Weight (kg)	D x S
TA2 Mounting bracket, double (Ø 108 x 200)	147-0097		130	108 x 200	7.50	108 x 200



TA2-L Mounting bracket, double (Ø 108 x 200)	147-0148	±90°	420	108 x 200	20.20	108 x 200
--	----------	------	-----	-----------	-------	-----------



FLC230 LED [FP]

Description	Part ID	A	C1	D x L1	Weight (kg)	D x S
TA2-L Mounting bracket, double (Ø 76 x 200)	147-0105	±90°	420	76 x 200	16.10	76 x 200

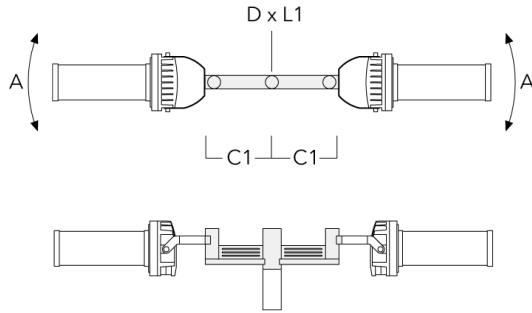

TA3 Mounting bracket, triple (Ø 89 x 200)	147-0025	±90°	650	89 x 200	17.90	89 x 200
---	----------	------	-----	----------	-------	----------

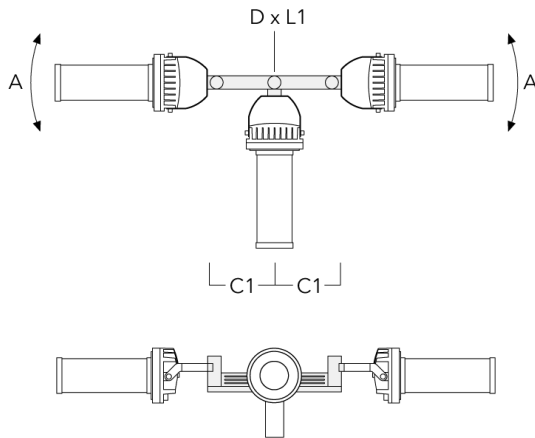

FLC230 LED [FP]

Description	Part ID	A	C1	D x L1	Weight (kg)	D x S
TA3 Mounting bracket, triple (Ø 108 x 200)	147-0098	±90°	650	108 x 200	24.20	108 x 200

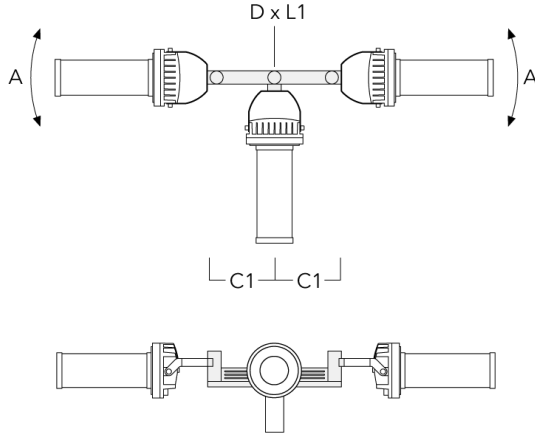

TA4 Mounting bracket, quad (Ø 89 x 200)	147-0099	±90°	650	89 x 200	20.80	89 x 200
---	----------	------	-----	----------	-------	----------



FLC230 LED [FP]

Description	Part ID	A	C1	D × L1	Weight (kg)	D × S
TA4 Mounting bracket, quad (Ø 108 x 200)	147-0100	±90°	650	108 x 200	24.20	108 x 200



Pole clamp TS

Description	Part ID	D1	Weight (kg)	D
TS1-2/M12 Pole clamp, single (Ø 102-114)	147-0526	102-114	1.50	102-114



FLC230 LED [FP]

Description	Part ID	D1	Weight (kg)	D
TS1-2/M12 Pole clamp, single (Ø 114-133)	147-0544	114-133	1.70	114-133



TS2-2/M12 Pole clamp, double (Ø 102-114)	147-0527	102-114	1.50	102-114
--	----------	---------	------	---------

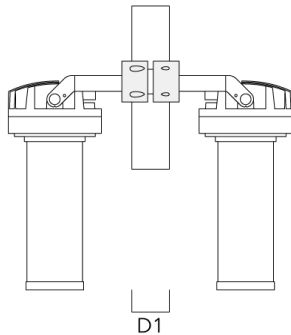

FLC230 LED [FP]

Description	Part ID	D1	Weight (kg)	D
TS2-2/M12 Pole clamp, double (Ø 76-89)	147-0545	76-89	1.40	76-89

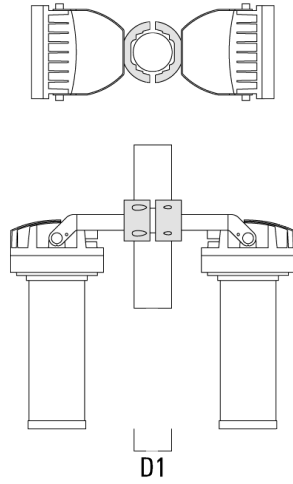

TS2-2/M12 Pole clamp, double (Ø 114-133)	147-0546	114-133	1.60	114-133
--	----------	---------	------	---------

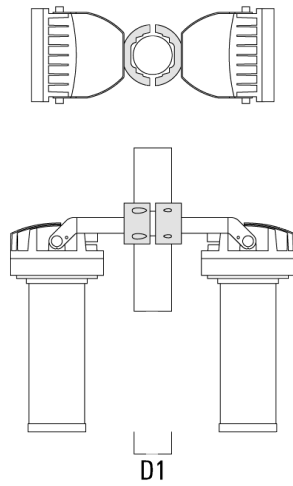

FLC230 LED [FP]

Description	Part ID	D1	Weight (kg)	D
TS1-2/M12 Pole clamp, single (Ø 76-89)	147-0543	76-89	1.40	76-89



Planted root

Description	Part ID	D1	D2	D3	D4	H1	H2	M1	Weight (kg)
Planted root ESV4	300-0461	145	130	60	89	400	350	8	3.83



Pole clamp PC

Fagerhult Lighting Ltd

33-34 Dolben Street, SE1 0UQ London, United Kingdom

<https://we-ef.com/uk>

Subject to technical changes and errors. - Generated on 23/10/2024

FLC230 LED [FP]

Description	Part ID	D1	Weight (kg)
PC1 76-89/60 Pole clamp, single (Ø 76-89)	139-2702	76-89	1.00



PC2 76-89/60 Pole clamp, double (Ø 76-89)	139-2703	76-89	1.00
---	----------	-------	------



FLC230 LED [FP]

Description	Part ID	D1	Weight (kg)
PC1 82-109/60 Pole clamp, single (Ø 82-109)	139-2704	82-109	1.10



PC2 82-109/60 Pole clamp, double (Ø 82-109)	139-2705	82-109	1.10
---	----------	--------	------



FLC230 LED [FP]

Description	Part ID	D1	Weight (kg)
PC1 102-114/60 Pole clamp, single (Ø 102-114)	139-2706	102-114	1.20



PC2 102-114/60 Pole clamp, double (Ø 102-114)	139-2707	102-114	1.20
--	----------	---------	------



FLC230 LED [FP]

Description	Part ID	D1	Weight (kg)
PC1 114-133/60 Pole clamp, single (Ø 114-133)	139-2708	114-133	1.40



PC2 114-133/60 Pole clamp, double (Ø 114-133)	139-2709	114-133	1.40
--	----------	---------	------



Control

Eco Step Dim® Basic

Description	Part ID
Eco Step Dim® Basic LED	430-0001

Eco Step Dim® Advanced

Description	Part ID
Eco Step Dim® Advanced LED	430-0002

R2C Ready to Connect

Description	Part ID
R2C Ready to Connect (top)	430-0019

139-3004_max

FLC230 LED [FP]

Fagerhult Lighting Ltd

33-34 Dolben Street, SE1 0UQ London, United Kingdom

<https://we-ef.com/uk>

Subject to technical changes and errors.

Generated on 23/10/2024