



Beschreibung

Projektor [FP] zur konturgenauen Ausleuchtung polygoner Flächen. Sphärisches / dreifaches Plankonvexlinsensystem zur Erzeugung eines parallelen Lichtbündels.

IP66, SKI. SKII auf Anfrage. IK07. Korrosionsbeständiger Aluminiumguss. PCS beschichtete Edelstahlschrauben. 5CE Korrosionsschutz. CCG® Silikondichtung. Sicherheitsglas. Eine Kabelverschraubung, eine zweite Kabelverschraubung zur Durchverdrahtung auf Anfrage. PMMA LED Linse. Eingebaute LED Platine, austauschbar. Eingebaute elektronische Betriebsgeräte, thermisch getrennt. Variante mit 2200 K bis max. 1050 mA erhältlich, bei Bestellung bitte angeben.

Gewicht	10.80 kg
Lichtverteilung	symmetrisch Framing-Projector [FP] - min. Öffnungswinkel
Lichtquelle	LED-FT-48W / 1100 mA - 4000 K
CRI	80
Netz	EVG
LEDs	1
Bemessungsleistung	53 W

Bemessungslichtstrom (lm)

LED Lumen	3985.4
Total Lumen	3985.4
Ta	25

Nominal Lichtstrom (lm)

LED Lumen	6960
Total Lumen	6960
Tc	25

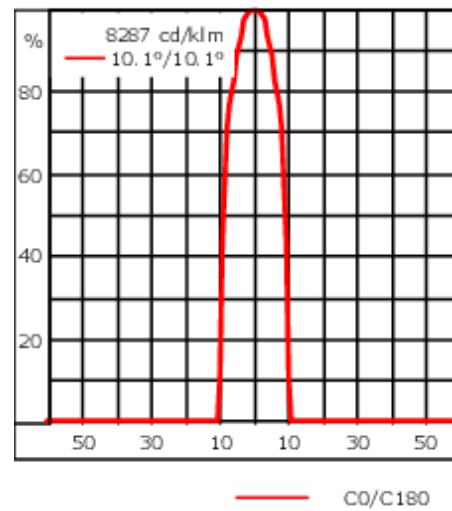

Spezifikationen

Materialbeschreibung

Gehäuse	Korrosionsbeständiger Aluminiumguss
Abdeckung	Sicherheitsglasscheibe
Farben	<div style="display: flex; align-items: center; gap: 10px;"> <div style="width: 20px; height: 15px; background-color: black; margin-right: 5px;"></div> RAL9004 Signalschwarz </div> <div style="display: flex; align-items: center; gap: 10px;"> <div style="width: 20px; height: 15px; background-color: #cccccc; margin-right: 5px;"></div> RAL9006 Weißaluminium </div> <div style="display: flex; align-items: center; gap: 10px;"> <div style="width: 20px; height: 15px; background-color: #808080; margin-right: 5px;"></div> RAL9007 Graualuminium </div> <div style="display: flex; align-items: center; gap: 10px;"> <div style="width: 20px; height: 15px; background-color: #333333; margin-right: 5px;"></div> RAL7016 Anthrazitgrau </div> <div style="display: flex; align-items: center; gap: 10px;"> <div style="width: 20px; height: 15px; background-color: #e0e0e0; margin-right: 5px;"></div> RAL9016 Verkehrsweiß </div>
Dichtung	CCG® Silikondichtung
Schrauben	PCS beschichtete Edelstahlschrauben
Schutzart	IP66
Schlagfestigkeit	IK07
Korrosionsbeständigkeit	5CE
Windangriffsfläche	0.114 m ²

Elektrische Beschreibung

Netz	220-240V / 50-60 Hz
Netzgerät / Vorschaltgerät	Standard. Variante mit DALI erhältlich, bei Bestellung bitte angeben.
Leistungsfaktor	> 0,9
Überspannungsschutz	6/6 kV (optional SP10)

WE-EF LEUCHTEN GmbH

Töpinger Straße 16, 29646 Bispingen, Germany - Tel: +49 5194 909-0

info.germany@we-ef.com - <https://we-ef.com/de>

Technische Änderungen und Irrtümer vorbehalten. - Erstellt am 23.11.2024

139-3006_min

FLC230 LED [FP]

we-ef

Weitere Informationen

Lebensdauer Ta=25° L70B50 > 50000h

Energieeffizienzklasse C-D (Lichtquelle)

WE-EF LEUCHTEN GmbH

Töpinger Straße 16, 29646 Bispingen, Germany - Tel: +49 5194 909-0

info.germany@we-ef.com - <https://we-ef.com/de>

Technische Änderungen und Irrtümer vorbehalten. - Erstellt am 23.11.2024

Montagezubehör

Montagesockel EM

Beschreibung	Artikelnummer	D1	D2	H1	M1	Gewicht (kg)
EM1-M16	270-9038	160	130	200	9	2



Mastaufsatztraverse TA

Beschreibung	Artikelnummer	A	C1	D x L1	Gewicht (kg)	D x S
TA1 Mastaufsatztraverse, einfach* (Ø 76 x 200)	147-0023		130	76 x 200	1.90	76 x 200

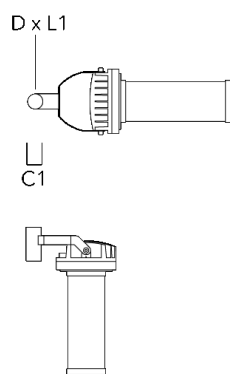

Beschreibung	Artikelnummer	A	C1	D × L1	Gewicht (kg)	D × S
TA1 Mastaufsatztraverse, einfach (Ø 108 x 200)	147-0096		130	108 x 200	7.50	108 x 200

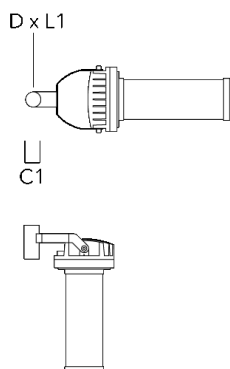

TA2 Mastaufsatztraverse, zweifach (Ø 76 x 200)	147-0024		130	76 x 200	1.90	76 x 200
--	----------	--	-----	----------	------	----------

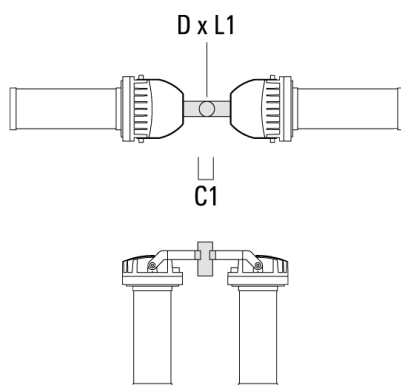

FLC230 LED [FP]

Beschreibung	Artikelnummer	A	C1	D x L1	Gewicht (kg)	D x S
TA2 Mastaufsatztraverse, zweifach (Ø 108 x 200)	147-0097		130	108 x 200	7.50	108 x 200

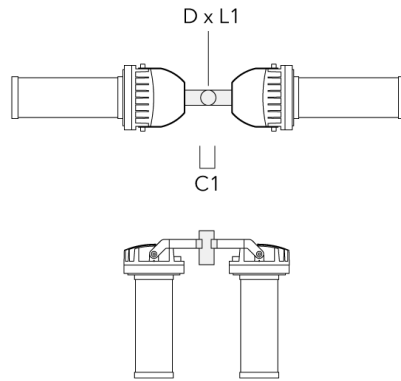

TA2-L Mastaufsatztraverse, zweifach (Ø 108 x 200)	147-0148	$\pm 90^\circ$	420	108 x 200	20.20	108 x 200
---	----------	----------------	-----	-----------	-------	-----------



FLC230 LED [FP]

Beschreibung	Artikelnummer	A	C1	D x L1	Gewicht (kg)	D x S
TA2-L Mastaufsatztraverse, zweifach (Ø 76 x 200)	147-0105	±90°	420	76 x 200	16.10	76 x 200

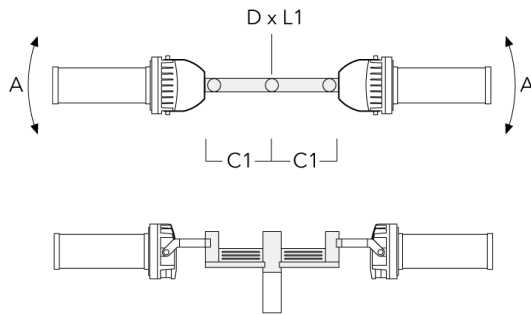

TA3 Mastaufsatztraverse, dreifach (Ø 89 x 200)	147-0025	±90°	650	89 x 200	17.90	89 x 200
--	----------	------	-----	----------	-------	----------



Beschreibung	Artikelnummer	A	C1	D x L1	Gewicht (kg)	D x S
TA3 Mastaufsatztraverse, dreifach (Ø 108 x 200)	147-0098	±90°	650	108 x 200	24.20	108 x 200



TA4 Mastaufsatztraverse, vierfach (Ø 89 x 200)	147-0099	±90°	650	89 x 200	20.80	89 x 200
--	----------	------	-----	----------	-------	----------

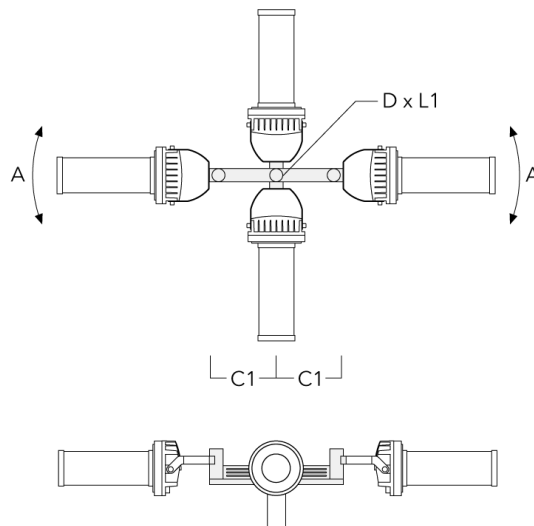

FLC230 LED [FP]

Beschreibung	Artikelnummer	A	C1	D × L1	Gewicht (kg)	D × S
TA4 Mastaufsatztraverse, vierfach (Ø 108 x 200)	147-0100	±90°	650	108 x 200	24.20	108 x 200



Mastschelle TS

Beschreibung	Artikelnummer	D1	Gewicht (kg)	D
TS1-2/M12 Mastschelle, einfach (Ø 102-114)	147-0526	102-114	1.50	102-114



FLC230 LED [FP]

Beschreibung	Artikelnummer	D1	Gewicht (kg)	D
TS1-2/M12 Mastschelle, einfach (Ø 114-133)	147-0544	114-133	1.70	114-133

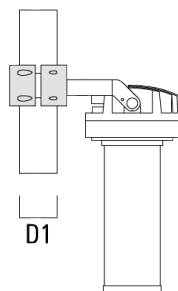
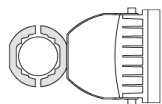

TS2-2/M12 Mastschelle, zweifach (Ø 102-114)	147-0527	102-114	1.50	102-114
---	----------	---------	------	---------

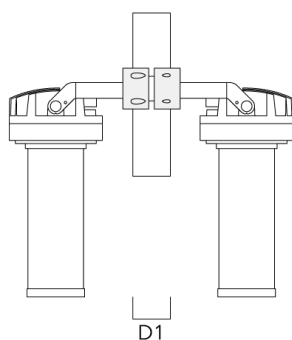
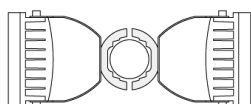

FLC230 LED [FP]

Beschreibung	Artikelnummer	D1	Gewicht (kg)	D
TS2-2/M12 Mastschelle, zweifach (Ø 76-89)	147-0545	76-89	1.40	76-89

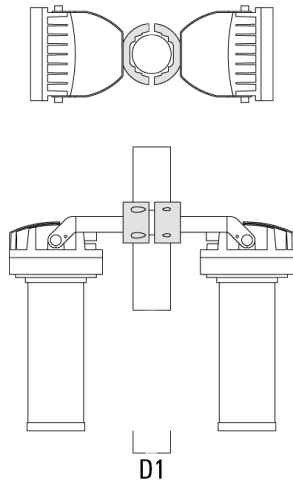

TS2-2/M12 Mastschelle, zweifach (Ø 114-133)	147-0546	114-133	1.60	114-133
---	----------	---------	------	---------



Beschreibung	Artikelnummer	D1	Gewicht (kg)	D
TS1-2/M12 Mastschelle, einfach (Ø 76-89)	147-0543	76-89	1.40	76-89

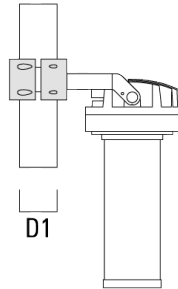
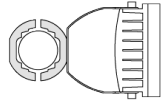

Erdstück

Beschreibung	Artikelnummer	D1	D2	D3	D4	H1	H2	M1	Gewicht (kg)
Erdstück ESV4	300-0461	145	130	60	89	400	350	8	3.83

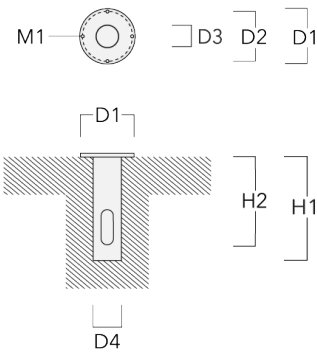

Mastschelle PC

Beschreibung	Artikelnummer	D1	Gewicht (kg)
PC1 76-89/60 Mastschelle, einfach (Ø 76-89)	139-2702	76-89	1.00

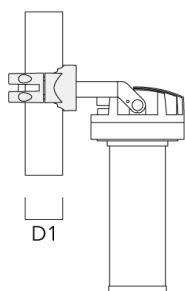
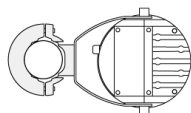

PC2 76-89/60 Mastschelle, zweifach (Ø 76-89)	139-2703	76-89	1.00
--	----------	-------	------

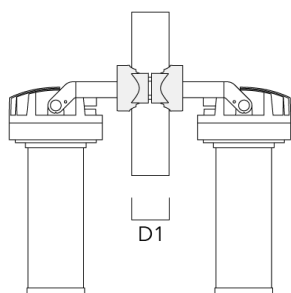
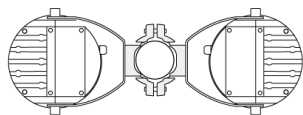

FLC230 LED [FP]

Beschreibung	Artikelnummer	D1	Gewicht (kg)
PC1 82-109/60 Mastschelle, einfach (Ø 82-109)	139-2704	82-109	1.10



PC2 82-109/60 Mastschelle, zweifach (Ø 82-109)	139-2705	82-109	1.10
---	----------	--------	------



FLC230 LED [FP]

Beschreibung	Artikelnummer	D1	Gewicht (kg)
PC1 102-114/60 Mastschelle, einfach (Ø 102-114)	139-2706	102-114	1.20

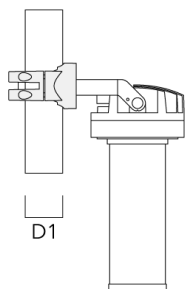
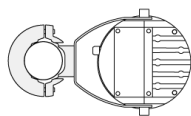

PC2 102-114/60 Mastschelle, zweifach (Ø 102-114)	139-2707	102-114	1.20
---	----------	---------	------

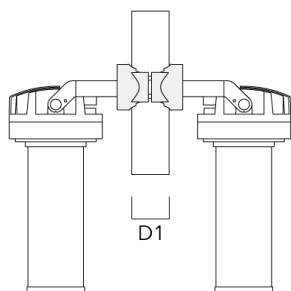

FLC230 LED [FP]

Beschreibung	Artikelnummer	D1	Gewicht (kg)
PC1 114-133/60 Mastschelle, einfach (Ø 144-133)	139-2708	114-133	1.40

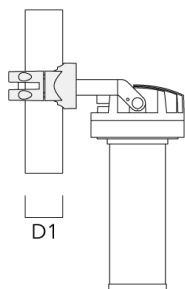
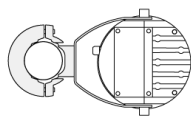

PC2 114-133/60 Mastschelle, zweifach (Ø 114-133)	139-2709	114-133	1.40
---	----------	---------	------

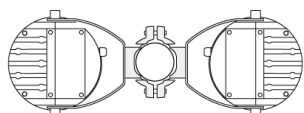

Steuerung**Eco Step Dim® Basic**

Beschreibung	Artikelnummer
Eco Step Dim® Basic LED	430-0001

Eco Step Dim® Advanced

Beschreibung	Artikelnummer
Eco Step Dim® Advanced LED	430-0002

R2C Ready to Connect

Beschreibung	Artikelnummer
R2C Ready to Connect (oben)	430-0019