



Description

Profile Projector [GP] for projection of gobos on a surface. Spherical/triple flat convex lens system. Gobo motif on request, to be ordered separately.

IP66, Class I. Class II on request. IK07. Marine-grade, die-cast aluminium alloy. 5CE superior corrosion protection including PCS hardware. Silicone CCG® Controlled Compression Gasket. Safety glass main lens. One cable gland. Second gland for through wiring on request. Integral EC electronic converter, thermally separated. LED boards can be removed for upgrading. PMMA LED lenses.

Optional 2200 K version up to max. 1050mA available. To be specified at time of ordering.

Gobo outside diameter 86 mm, max. printable area $d = 60$ mm. WE-EF recommendation = $d = 48$ mm.

| | |
|--------------------|--|
| Weight | 10.80 kg |
| Light distribution | symmetric Gobo-Projector [GP] - min aperture angle |
| Light source | LED-FT-48W / 1100 mA - 4000 K |
| CRI | 80 |
| Power supply | EC |
| LEDs | 1 |
| Rated input power | 53 W |

Rated lumens (lm)

| | |
|-------------|--------|
| LED Lumen | 3205.3 |
| Total Lumen | 3205.3 |
| Ta | 25 |

Nominal Lumen (lm)

| | |
|-------------|------|
| LED Lumen | 6960 |
| Total Lumen | 6960 |
| Tc | 25 |



Specifications

Material description

| | |
|----------------------|--|
| Body | Marine-grade, die-cast aluminium alloy |
| Lens | Safety glass lens |
| Colours | <div style="display: flex; align-items: center; margin-bottom: 5px;"> <div style="width: 20px; height: 15px; background-color: black; margin-right: 5px;"></div> RAL9004 Signal black </div> <div style="display: flex; align-items: center; margin-bottom: 5px;"> <div style="width: 20px; height: 15px; background-color: #cccccc; margin-right: 5px;"></div> RAL9006 White aluminium </div> <div style="display: flex; align-items: center; margin-bottom: 5px;"> <div style="width: 20px; height: 15px; background-color: #808080; margin-right: 5px;"></div> RAL9007 Grey aluminium </div> <div style="display: flex; align-items: center; margin-bottom: 5px;"> <div style="width: 20px; height: 15px; background-color: #333333; margin-right: 5px;"></div> RAL7016 Anthracite grey </div> <div style="display: flex; align-items: center;"> <div style="width: 20px; height: 15px; background-color: #e0e0e0; margin-right: 5px;"></div> RAL9016 Traffic white </div> |
| Gasket | Silicone CCG® Controlled Compression Gasket |
| Fasteners | PCS Polymer Coated Stainless Steel Hardware |
| Ingress protection | IP66 |
| Impact resistance | IK07 |
| Corrosion resistance | 5CE |
| Windage | 0.114 m ² |

Electrical description

| | |
|------------------|---|
| Power supply | 220-240V / 50-60 Hz |
| Driver / Ballast | Standard. Optional DALI version available. To be specified at time of ordering. |
| Power factor | > 0.9 |
| Surge protection | 6/6 kV (optional SP10) |

WE-EF LEUCHTEN GmbH

Töpinger Straße 16, 29646 Bispingen, Germany - Phone: +49 5194 909-0

info@we-ef.com - <https://we-ef.com>

Subject to technical changes and errors. - Generated on 23/10/2024

139-2994_min

FLC230 LED [GP]

we-ef

Additional information

Lifetime Ta=25° L70B50 > 50000h

Energy efficiency class C-D (Light source)

WE-EF LEUCHTEN GmbH

Töpinger Straße 16, 29646 Bispingen, Germany - Phone: +49 5194 909-0

info@we-ef.com - <https://we-ef.com>

Subject to technical changes and errors. - Generated on 23/10/2024

Mounting Accessories

Short post EM

| Description | Part ID | D1 | D2 | H1 | M1 | Weight (kg) |
|-------------|----------|-----|-----|-----|----|-------------|
| EM1-M16 | 270-9038 | 160 | 130 | 200 | 9 | 2 |



Floodlight mounting bracket TA

| Description | Part ID | A | C1 | D x L1 | Weight (kg) | D x S |
|--|----------|---|-----|----------|-------------|----------|
| TA1 Mounting bracket, single* (Ø 76 x 200) | 147-0023 | | 130 | 76 x 200 | 1.90 | 76 x 200 |



FLC230 LED [GP]

| Description | Part ID | A | C1 | D × L1 | Weight (kg) | D × S |
|--|----------|---|-----|-----------|-------------|-----------|
| TA1 Mounting bracket, single (Ø 108 x 200) | 147-0096 | | 130 | 108 x 200 | 7.50 | 108 x 200 |



| | | | | | | |
|--|----------|--|-----|----------|------|----------|
| TA2 Mounting bracket, double* (Ø 76 x 200) | 147-0024 | | 130 | 76 x 200 | 1.90 | 76 x 200 |
|--|----------|--|-----|----------|------|----------|



FLC230 LED [GP]

| Description | Part ID | A | C1 | D x L1 | Weight (kg) | D x S |
|--|----------|---|-----|-----------|-------------|-----------|
| TA2 Mounting bracket, double (Ø 108 x 200) | 147-0097 | | 130 | 108 x 200 | 7.50 | 108 x 200 |

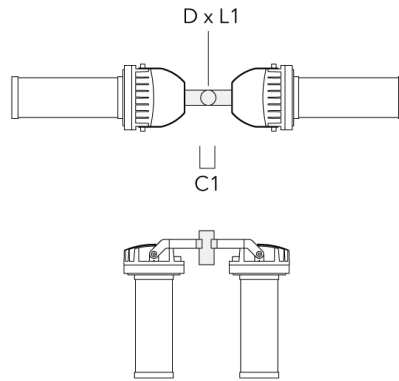

| | | | | | | |
|--|----------|----------------|-----|-----------|-------|-----------|
| TA2-L Mounting bracket, double (Ø 108 x 200) | 147-0148 | $\pm 90^\circ$ | 420 | 108 x 200 | 20.20 | 108 x 200 |
|--|----------|----------------|-----|-----------|-------|-----------|



FLC230 LED [GP]

| Description | Part ID | A | C1 | D x L1 | Weight (kg) | D x S |
|---|----------|------|-----|----------|-------------|----------|
| TA2-L Mounting bracket, double (Ø 76 x 200) | 147-0105 | ±90° | 420 | 76 x 200 | 16.10 | 76 x 200 |



| | | | | | | |
|---|----------|------|-----|----------|-------|----------|
| TA3 Mounting bracket, triple (Ø 89 x 200) | 147-0025 | ±90° | 650 | 89 x 200 | 17.90 | 89 x 200 |
|---|----------|------|-----|----------|-------|----------|



FLC230 LED [GP]

| Description | Part ID | A | C1 | D x L1 | Weight (kg) | D x S |
|--|----------|------|-----|-----------|-------------|-----------|
| TA3 Mounting bracket, triple (Ø 108 x 200) | 147-0098 | ±90° | 650 | 108 x 200 | 24.20 | 108 x 200 |



| | | | | | | |
|---|----------|------|-----|----------|-------|----------|
| TA4 Mounting bracket, quad (Ø 89 x 200) | 147-0099 | ±90° | 650 | 89 x 200 | 20.80 | 89 x 200 |
|---|----------|------|-----|----------|-------|----------|



FLC230 LED [GP]

| Description | Part ID | A | C1 | D × L1 | Weight (kg) | D × S |
|--|----------|------|-----|-----------|-------------|-----------|
| TA4 Mounting bracket, quad (Ø 108 x 200) | 147-0100 | ±90° | 650 | 108 x 200 | 24.20 | 108 x 200 |



Pole clamp TS

| Description | Part ID | D1 | Weight (kg) | D |
|--|----------|---------|-------------|---------|
| TS1-2/M12 Pole clamp, single (Ø 102-114) | 147-0526 | 102-114 | 1.50 | 102-114 |



FLC230 LED [GP]

| Description | Part ID | D1 | Weight (kg) | D |
|--|----------|---------|-------------|---------|
| TS1-2/M12 Pole clamp, single (Ø 114-133) | 147-0544 | 114-133 | 1.70 | 114-133 |

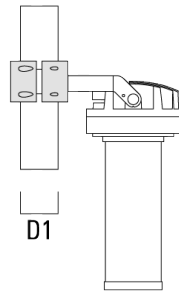
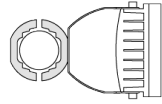

| | | | | |
|--|----------|---------|------|---------|
| TS2-2/M12 Pole clamp, double (Ø 102-114) | 147-0527 | 102-114 | 1.50 | 102-114 |
|--|----------|---------|------|---------|

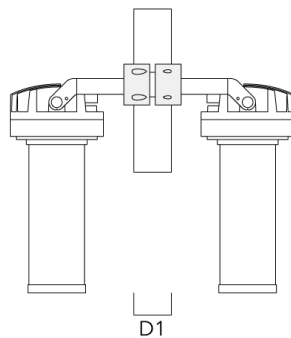
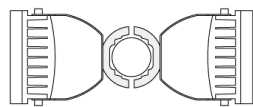

FLC230 LED [GP]

| Description | Part ID | D1 | Weight (kg) | D |
|--|----------|-------|-------------|-------|
| TS2-2/M12 Pole clamp, double (Ø 76-89) | 147-0545 | 76-89 | 1.40 | 76-89 |

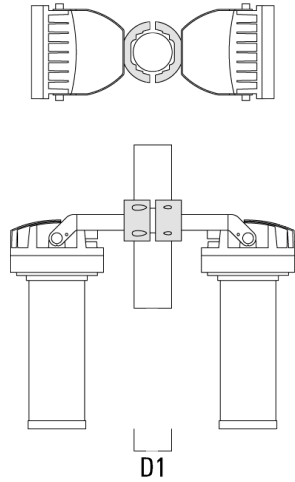

| | | | | |
|--|----------|---------|------|---------|
| TS2-2/M12 Pole clamp, double (Ø 114-133) | 147-0546 | 114-133 | 1.60 | 114-133 |
|--|----------|---------|------|---------|

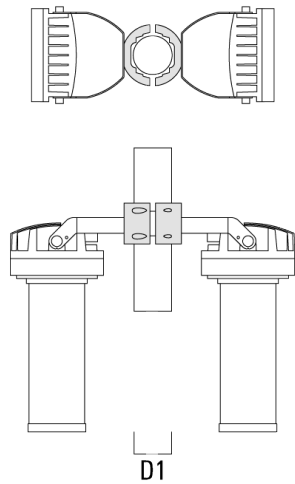

FLC230 LED [GP]

| Description | Part ID | D1 | Weight (kg) | D |
|--|----------|-------|-------------|-------|
| TS1-2/M12 Pole clamp, single (Ø 76-89) | 147-0543 | 76-89 | 1.40 | 76-89 |



Planted root

| Description | Part ID | D1 | D2 | D3 | D4 | H1 | H2 | M1 | Weight (kg) |
|-------------------|----------|-----|-----|----|----|-----|-----|----|-------------|
| Planted root ESV4 | 300-0461 | 145 | 130 | 60 | 89 | 400 | 350 | 8 | 3.83 |



Pole clamp PC

WE-EF LEUCHTEN GmbH

Töpinger Straße 16, 29646 Bispingen, Germany - Phone: +49 5194 909-0

info@we-ef.com - <https://we-ef.com>

Subject to technical changes and errors. - Generated on 23/10/2024

FLC230 LED [GP]

| Description | Part ID | D1 | Weight (kg) |
|---|----------|-------|-------------|
| PC1 76-89/60 Pole clamp, single (Ø 76-89) | 139-2702 | 76-89 | 1.00 |



| | | | |
|---|----------|-------|------|
| PC2 76-89/60 Pole clamp, double (Ø 76-89) | 139-2703 | 76-89 | 1.00 |
|---|----------|-------|------|



FLC230 LED [GP]

| Description | Part ID | D1 | Weight (kg) |
|---|----------|--------|-------------|
| PC1 82-109/60 Pole clamp, single (Ø 82-109) | 139-2704 | 82-109 | 1.10 |



| | | | |
|---|----------|--------|------|
| PC2 82-109/60 Pole clamp, double (Ø 82-109) | 139-2705 | 82-109 | 1.10 |
|---|----------|--------|------|



FLC230 LED [GP]

| Description | Part ID | D1 | Weight (kg) |
|--|----------|---------|-------------|
| PC1 102-114/60 Pole clamp, single (Ø 102-114) | 139-2706 | 102-114 | 1.20 |



| | | | |
|--|----------|---------|------|
| PC2 102-114/60 Pole clamp, double (Ø 102-114) | 139-2707 | 102-114 | 1.20 |
|--|----------|---------|------|



FLC230 LED [GP]

| Description | Part ID | D1 | Weight (kg) |
|--|----------|---------|-------------|
| PC1 114-133/60 Pole clamp, single (Ø 114-133) | 139-2708 | 114-133 | 1.40 |



| | | | |
|--|----------|---------|------|
| PC2 114-133/60 Pole clamp, double (Ø 114-133) | 139-2709 | 114-133 | 1.40 |
|--|----------|---------|------|



Control

Eco Step Dim® Basic

| Description | Part ID |
|-------------------------|----------|
| Eco Step Dim® Basic LED | 430-0001 |

Eco Step Dim® Advanced

| Description | Part ID |
|----------------------------|----------|
| Eco Step Dim® Advanced LED | 430-0002 |

R2C Ready to Connect

| Description | Part ID |
|----------------------------|----------|
| R2C Ready to Connect (top) | 430-0019 |

139-2994_min

FLC230 LED [GP]

WE-EF LEUCHTEN GmbH

Töpinger Straße 16, 29646 Bispingen, Germany

Phone: +49 5194 909-0

info@we-ef.com

<https://we-ef.com>

Subject to technical changes and errors.

Generated on 23/10/2024