



### Description

IP66, Class I. Class II on request. IK07. Marine-grade, die-cast aluminium alloy. 5CE superior corrosion protection including PCS hardware. Silicone CCG® Controlled Compression Gasket. Safety glass lens. One cable gland. Second gland for through wiring on request. PMMA LED lens array. Factory installed LED circuit board. LED board can be removed for upgrading. Integral EC electronic converter, thermally separated.

Optional 2200 K version up to max. 1050mA available. To be specified at time of ordering.

|                           |  |
|---------------------------|--|
| Weight                    | 10.80 kg   |
| Light distribution        | symmetric Zoom-Projector [ZP] - max aperture angle |
| Light source              | LED-FT-36W / 850 mA - 4000 K                       |
| CRI                       | 80   |
| Power supply              | EC   |
| LEDs                      | 1  |
| Rated input power         | 39 W   |
| <b>Rated lumens (lm)</b>  |  |
| LED Lumen                 | 2790.1   |
| Total Lumen               | 2790.1   |
| Ta                        | 25   |
| <b>Nominal Lumen (lm)</b> |  |
| LED Lumen                 | 5450   |
| Total Lumen               | 5450   |
| Tc                        | 25   |

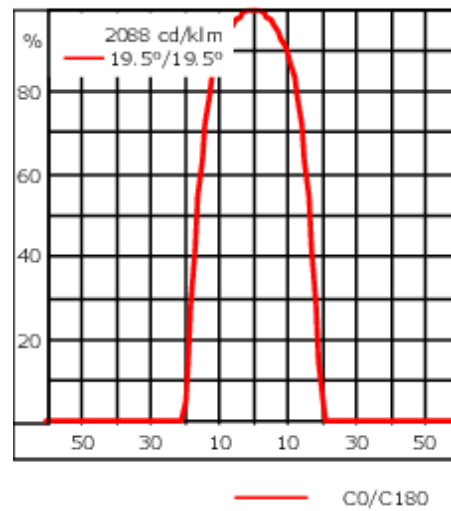
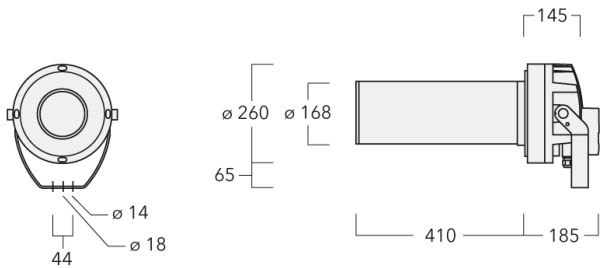

## Specifications

### Material description

|                      |  |
|----------------------|--|
| Body                 | Marine-grade, die-cast aluminium alloy   |
| Lens                 | Safety glass lens  |
| Colours              | <div style="display: flex; align-items: center; gap: 10px;"> <div style="width: 20px; height: 15px; background-color: black; margin-right: 5px;"></div> RAL9004 Signal black         </div> <div style="display: flex; align-items: center; gap: 10px; margin-top: 5px;"> <div style="width: 20px; height: 15px; background-color: #cccccc; margin-right: 5px;"></div> RAL9006 White aluminium         </div> <div style="display: flex; align-items: center; gap: 10px; margin-top: 5px;"> <div style="width: 20px; height: 15px; background-color: #808080; margin-right: 5px;"></div> RAL9007 Grey aluminium         </div> <div style="display: flex; align-items: center; gap: 10px; margin-top: 5px;"> <div style="width: 20px; height: 15px; background-color: #333333; margin-right: 5px;"></div> RAL7016 Anthracite grey         </div> <div style="display: flex; align-items: center; gap: 10px; margin-top: 5px;"> <div style="width: 20px; height: 15px; background-color: #e0e0e0; margin-right: 5px;"></div> RAL9016 Traffic white         </div> |
| Gasket               | Silicone CCG® Controlled Compression Gasket  |
| Fasteners            | PCS Polymer Coated Stainless Steel Hardware  |
| Ingress protection   | IP66   |
| Impact resistance    | IK07   |
| Corrosion resistance | 5CE  |
| Windage              | 0.114 m <sup>2</sup>   |

### Electrical description

|                  |   |
|------------------|---|
| Power supply     | 220-240V / 50-60 Hz   |
| Driver / Ballast | Standard. Optional DALI version available. To be specified at time of ordering. |
| Power factor     | > 0.9   |
| Surge protection | 6/6 kV (optional SP10)  |

**139-3017\_max**

**FLC230 LED [ZP]**

**we-ef**

**Additional information**

---

|          |                        |
|----------|------------------------|
| Lifetime | Ta=25° L70B50 > 50000h |
|----------|------------------------|

---

**Fagerhult Lighting Ltd**

33-34 Dolben Street, SE1 0UQ London, United Kingdom

<https://we-ef.com/uk>

Subject to technical changes and errors. - Generated on 23/11/2024

## Mounting Accessories

### Short post EM

| Description | Part ID  | D1  | D2  | H1  | M1 | Weight (kg) |
|-------------|----------|-----|-----|-----|----|-------------|
| EM1-M16     | 270-9038 | 160 | 130 | 200 | 9  | 2           |



### Floodlight mounting bracket TA

| Description                                | Part ID  | A | C1  | D x L1    | Weight (kg) | D x S     |
|--|----------|---|-----|-----------|-------------|-----------|
| TA1 Mounting bracket, single (Ø 108 x 200) | 147-0096 |   | 130 | 108 x 200 | 7.50        | 108 x 200 |



**FLC230 LED [ZP]**

| Description                                | Part ID  | A | C1  | D × L1    | Weight (kg) | D × S     |
|--|----------|---|-----|-----------|-------------|-----------|
| TA2 Mounting bracket, double (Ø 108 x 200) | 147-0097 |   | 130 | 108 x 200 | 7.50        | 108 x 200 |



|  |          |      |     |           |       |           |
|--|----------|------|-----|-----------|-------|-----------|
| TA2-L Mounting bracket, double (Ø 108 x 200) | 147-0148 | ±90° | 420 | 108 x 200 | 20.20 | 108 x 200 |
|--|----------|------|-----|-----------|-------|-----------|



**FLC230 LED [ZP]**

| Description                                 | Part ID  | A    | C1  | D x L1   | Weight (kg) | D x S    |
|---|----------|------|-----|----------|-------------|----------|
| TA2-L Mounting bracket, double (Ø 76 x 200) | 147-0105 | ±90° | 420 | 76 x 200 | 16.10       | 76 x 200 |



|   |          |      |     |          |       |          |
|---|----------|------|-----|----------|-------|----------|
| TA3 Mounting bracket, triple (Ø 89 x 200) | 147-0025 | ±90° | 650 | 89 x 200 | 17.90 | 89 x 200 |
|---|----------|------|-----|----------|-------|----------|



**FLC230 LED [ZP]**

| Description                                | Part ID  | A    | C1  | D x L1    | Weight (kg) | D x S     |
|--|----------|------|-----|-----------|-------------|-----------|
| TA3 Mounting bracket, triple (Ø 108 x 200) | 147-0098 | ±90° | 650 | 108 x 200 | 24.20       | 108 x 200 |



|   |          |      |     |          |       |          |
|---|----------|------|-----|----------|-------|----------|
| TA4 Mounting bracket, quad (Ø 89 x 200) | 147-0099 | ±90° | 650 | 89 x 200 | 20.80 | 89 x 200 |
|---|----------|------|-----|----------|-------|----------|

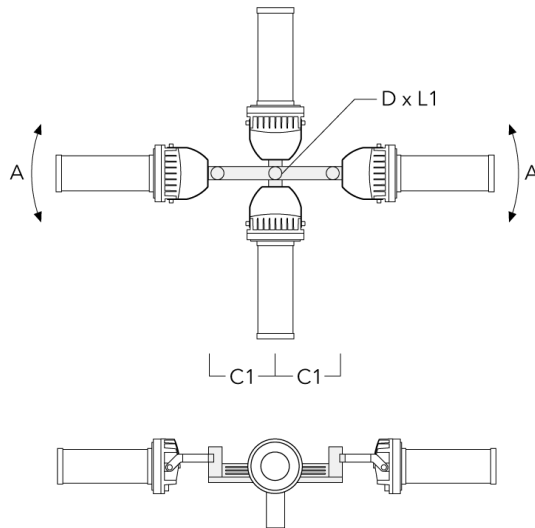

**FLC230 LED [ZP]**

| Description                              | Part ID  | A    | C1  | D × L1    | Weight (kg) | D × S     |
|--|----------|------|-----|-----------|-------------|-----------|
| TA4 Mounting bracket, quad (Ø 108 x 200) | 147-0100 | ±90° | 650 | 108 x 200 | 24.20       | 108 x 200 |



**Pole clamp TS**

| Description                              | Part ID  | D1      | Weight (kg) | D       |
|--|----------|---------|-------------|---------|
| TS1-2/M12 Pole clamp, single (Ø 102-114) | 147-0526 | 102-114 | 1.50        | 102-114 |

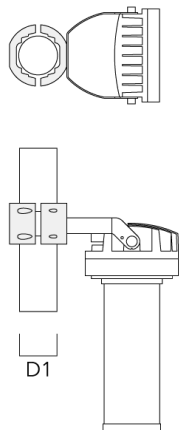



## FLC230 LED [ZP]

| Description                              | Part ID  | D1      | Weight (kg) | D       |
|--|----------|---------|-------------|---------|
| TS1-2/M12 Pole clamp, single (Ø 114-133) | 147-0544 | 114-133 | 1.70        | 114-133 |

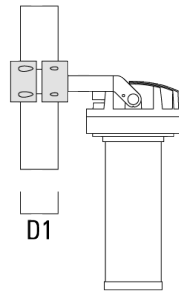
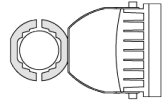

|  |          |         |      |         |
|--|----------|---------|------|---------|
| TS2-2/M12 Pole clamp, double (Ø 102-114) | 147-0527 | 102-114 | 1.50 | 102-114 |
|--|----------|---------|------|---------|

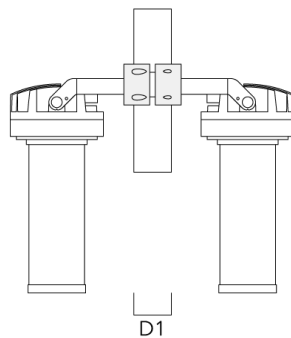
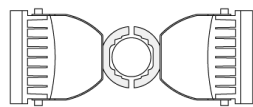

## FLC230 LED [ZP]

| Description                            | Part ID  | D1    | Weight (kg) | D     |
|--|----------|-------|-------------|-------|
| TS2-2/M12 Pole clamp, double (Ø 76-89) | 147-0545 | 76-89 | 1.40        | 76-89 |



|  |          |         |      |         |
|--|----------|---------|------|---------|
| TS2-2/M12 Pole clamp, double (Ø 114-133) | 147-0546 | 114-133 | 1.60 | 114-133 |
|--|----------|---------|------|---------|

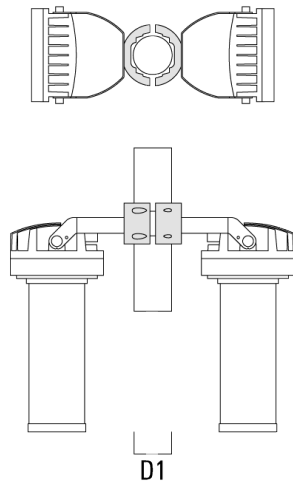

**FLC230 LED [ZP]**

| Description                            | Part ID  | D1    | Weight (kg) | D     |
|--|----------|-------|-------------|-------|
| TS1-2/M12 Pole clamp, single (Ø 76-89) | 147-0543 | 76-89 | 1.40        | 76-89 |



**Planted root**

| Description       | Part ID  | D1  | D2  | D3 | D4 | H1  | H2  | M1 | Weight (kg) |
|-------------------|----------|-----|-----|----|----|-----|-----|----|-------------|
| Planted root ESV4 | 300-0461 | 145 | 130 | 60 | 89 | 400 | 350 | 8  | 3.83        |



## FLC230 LED [ZP]

## Pole clamp PC

| Description                               | Part ID  | D1    | Weight (kg) |
|---|----------|-------|-------------|
| PC1 76-89/60 Pole clamp, single (Ø 76-89) | 139-2702 | 76-89 | 1.00        |

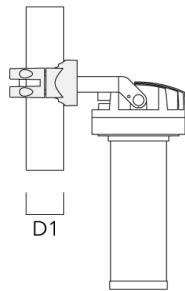
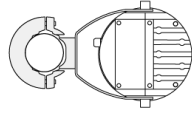

|   |          |       |      |
|---|----------|-------|------|
| PC2 76-89/60 Pole clamp, double (Ø 76-89) | 139-2703 | 76-89 | 1.00 |
|---|----------|-------|------|

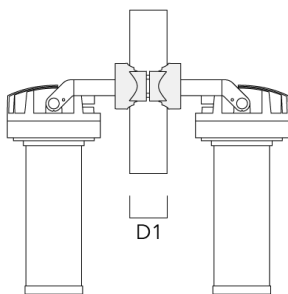
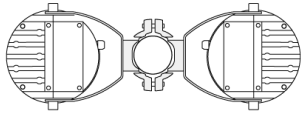

**FLC230 LED [ZP]**

| Description                                 | Part ID  | D1     | Weight (kg) |
|---|----------|--------|-------------|
| PC1 82-109/60 Pole clamp, single (Ø 82-109) | 139-2704 | 82-109 | 1.10        |



|   |          |        |      |
|---|----------|--------|------|
| PC2 82-109/60 Pole clamp, double (Ø 82-109) | 139-2705 | 82-109 | 1.10 |
|---|----------|--------|------|



## FLC230 LED [ZP]

---

| Description                                      | Part ID  | D1      | Weight (kg) |
|--|----------|---------|-------------|
| PC1 102-114/60 Pole clamp, single<br>(Ø 102-114) | 139-2706 | 102-114 | 1.20        |

---



---

|  |          |         |      |
|--|----------|---------|------|
| PC2 102-114/60 Pole clamp, double<br>(Ø 102-114) | 139-2707 | 102-114 | 1.20 |
|--|----------|---------|------|

---



## FLC230 LED [ZP]

---

| Description                                      | Part ID  | D1      | Weight (kg) |
|--|----------|---------|-------------|
| PC1 114-133/60 Pole clamp, single<br>(Ø 114-133) | 139-2708 | 114-133 | 1.40        |

---



---

|  |          |         |      |
|--|----------|---------|------|
| PC2 114-133/60 Pole clamp, double<br>(Ø 114-133) | 139-2709 | 114-133 | 1.40 |
|--|----------|---------|------|

---



## Control

### Eco Step Dim® Basic

| Description             | Part ID  |
|-------------------------|----------|
| Eco Step Dim® Basic LED | 430-0001 |

### Eco Step Dim® Advanced

| Description                | Part ID  |
|----------------------------|----------|
| Eco Step Dim® Advanced LED | 430-0002 |

### R2C Ready to Connect

| Description                | Part ID  |
|----------------------------|----------|
| R2C Ready to Connect (top) | 430-0019 |