



### Description

Projecteur LED à SPOT. Projection de forme ronde précise.

IP66. Classe I. Classe II sur demande. IK07. Corps en fonte d'aluminium. Visserie inox avec traitement PCS.

Protection contre la corrosion 5CE. Joint silicone. Verre de sécurité. Circuit LED installé en usine. (Dé)montage facile sans dérégler le train optique. Une entrée de câble (seconde entrée en option, sur demande). Driver électronique séparé thermiquement, protection surtension 6/6kV intégrée.

Poids	10.80 kg
Distribution de la lumière	symmetric Zoom-Projector [ZP] - min aperture angle
Source lumineuse	LED-FT-48W / 1100 mA - 3000 K
IRC	80
Alimentation électrique	ballast électronique
LEDs	1
Rated input power	53 W
<b>Rated lumens (lm)</b>	
LED Lumen	3719.1
Total Lumen	3719.1
Ta	25
<b>Flux lumineux nominal (lm)</b>	
LED Lumen	6495
Total Lumen	6495
Tc	25

### WE-EF Switzerland AG

Himmelrichstrasse 6, 6003 Luzern - Téléphone: +41 22 752 49 94

info.switzerland@we-ef.com - [https://we-ef.com/ch\\_fr](https://we-ef.com/ch_fr)

Sous réserve de modifications techniques et d'erreurs. - Généré le 23/11/2024

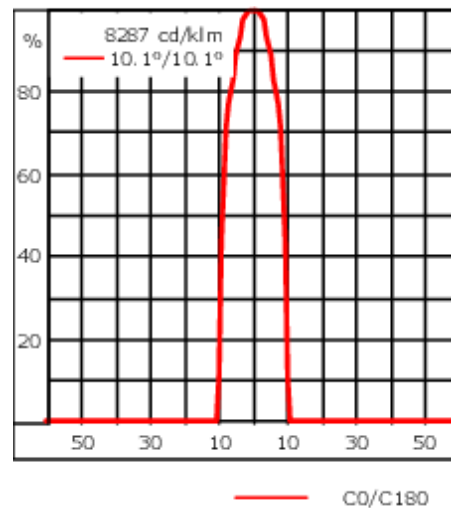

## Spécifications

### Description du matériel

Corps	Corps en fonte d'aluminium
Lentille	Verre de sécurité
Couleurs	<div style="display: flex; flex-direction: column; gap: 5px;"> <div style="display: flex; align-items: center;"> <div style="width: 20px; height: 10px; background-color: black; margin-right: 5px;"></div> <span>RAL9004 Noir de sécurité</span> </div> <div style="display: flex; align-items: center;"> <div style="width: 20px; height: 10px; background-color: #808080; margin-right: 5px;"></div> <span>RAL9007 Aluminium gris</span> </div> <div style="display: flex; align-items: center;"> <div style="width: 20px; height: 10px; background-color: #333333; margin-right: 5px;"></div> <span>RAL7016 Gris anthracite</span> </div> <div style="display: flex; align-items: center;"> <div style="width: 20px; height: 10px; background-color: #e0e0e0; margin-right: 5px;"></div> <span>RAL9016 Blanc signalisation</span> </div> </div>
Joint	Joint silicone CCG®
Visserie	PCS Inox avec recouvrement polymère
IP	IP66
IK	IK07
Protection contre la corrosion	5CE
Surface exposée au vent	0.114 m <sup>2</sup>

### Description électrique

Alimentation électrique	220-240V / 50-60 Hz
Driver	Standard - version DALI disponible en option
Power factor	> 0.9

#### WE-EF Switzerland AG

Himmelrichstrasse 6, 6003 Luzern - Téléphone: +41 22 752 49 94

info.switzerland@we-ef.com - [https://we-ef.com/ch\\_fr](https://we-ef.com/ch_fr)

Sous réserve de modifications techniques et d'erreurs. - Généré le 23/11/2024

**139-3016\_min**

**FLC230 LED [ZP]**

**we-ef**

**Informations complémentaires**

---

Durée de vie Ta=25° L70B50 > 50000h

---

**WE-EF Switzerland AG**

Himmelrichstrasse 6, 6003 Luzern - Téléphone: +41 22 752 49 94

info.switzerland@we-ef.com - [https://we-ef.com/ch\\_fr](https://we-ef.com/ch_fr)

Sous réserve de modifications techniques et d'erreurs. - Généré le 23/11/2024

## Accessoires d'installation

### Socle de montage EM

Description	Référence	D1	D2	H1	M1	Poids (kg)
EM1-M16 socle de montage	270-9038	160	130	200	9	2

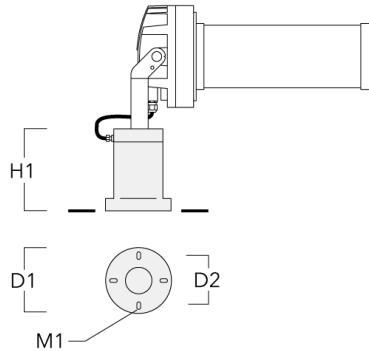

### Traverse pour mâts

Description	Référence	A	C1	D x L1	Poids (kg)	D x S
TA1 traverse simple (Ø 108 x 200)	147-0096		130	108 x 200	7.50	108 x 200

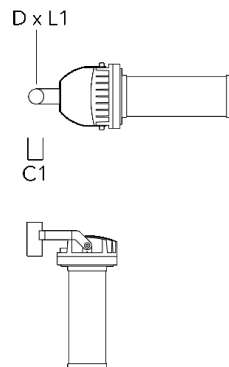

## FLC230 LED [ZP]

Description	Référence	A	C1	D x L1	Poids (kg)	D x S
TA2 traverse double (Ø 108 x 200)	147-0097		130	108 x 200	7.50	108 x 200



TA2-L traverse longue orientable (Ø 108 x 200)	147-0148	$\pm 90^\circ$	420	108 x 200	20.20	108 x 200
--	----------	----------------	-----	-----------	-------	-----------

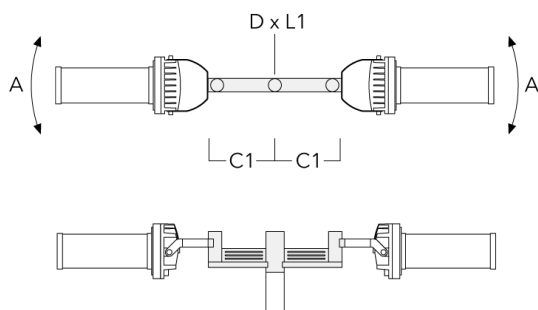

## FLC230 LED [ZP]

Description	Référence	A	C1	D x L1	Poids (kg)	D x S
TA2-L traverse longue orientable (Ø 76 x 200)	147-0105	±90°	420	76 x 200	16.10	76 x 200

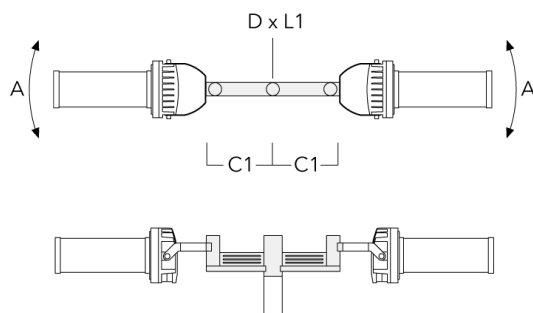

TA3 traverse triple orientable (Ø 89 x 200)	147-0025	±90°	650	89 x 200	17.90	89 x 200
---	----------	------	-----	----------	-------	----------



## FLC230 LED [ZP]

Description	Référence	A	C1	D x L1	Poids (kg)	D x S
TA3 traverse triple orientable (Ø 108 x 200)	147-0098	±90°	650	108 x 200	24.20	108 x 200

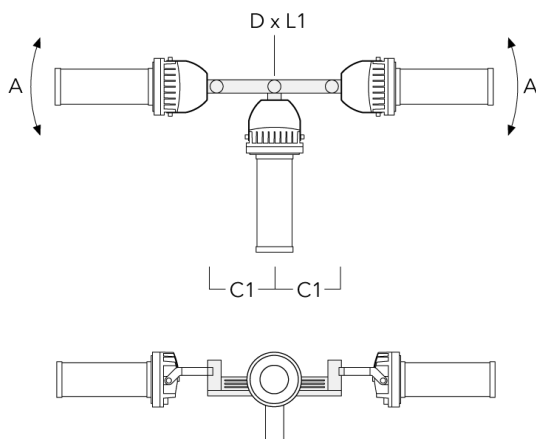

TA4-L Traverse pour 4 projecteurs (Ø 89 x 200)	147-0099	±90°	650	89 x 200	20.80	89 x 200
--	----------	------	-----	----------	-------	----------



## FLC230 LED [ZP]

Description	Référence	A	C1	D x L1	Poids (kg)	D x S
TA4 Traverse pour 4 projecteurs (Ø 108 x 200)	147-0100	±90°	650	108 x 200	24.20	108 x 200

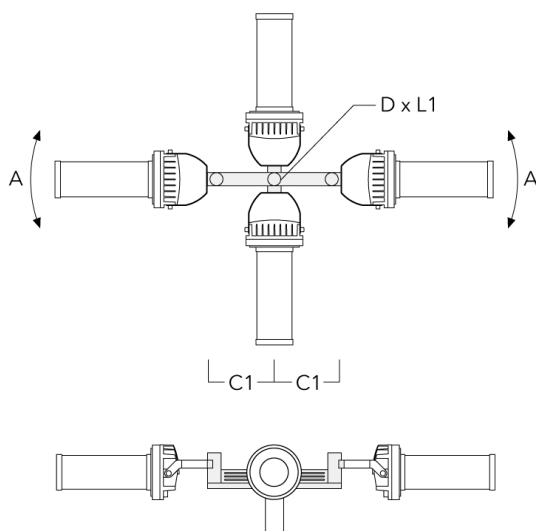

## Collier pour mâts TS

Description	Référence	D1	Poids (kg)	D
TS1-2/M12 collier simple pour tube (Ø 102-114)	147-0526	102-114	1.50	102-114

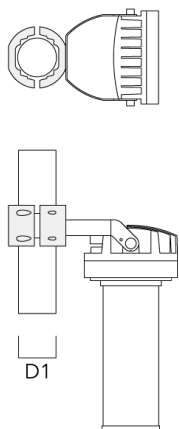



## FLC230 LED [ZP]

Description	Référence	D1	Poids (kg)	D
TS1-2/M12 collier simple pour tube (Ø 114-133)	147-0544	114-133	1.70	114-133

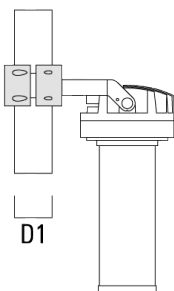
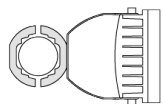

TS2-2/M12 collier double pour tube (Ø 102-114)	147-0527	102-114	1.50	102-114
---	----------	---------	------	---------

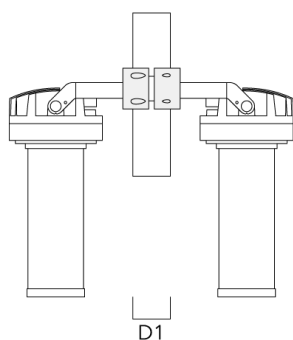
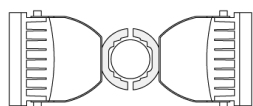

## FLC230 LED [ZP]

Description	Référence	D1	Poids (kg)	D
TS2-2/M12 collier double pour tube (Ø 76-89)	147-0545	76-89	1.40	76-89

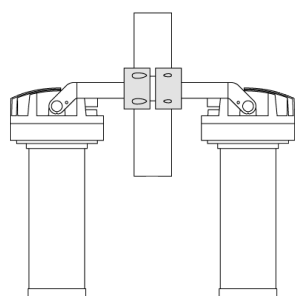
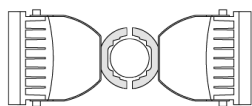

D1

TS2-2/M12 collier double pour tube (Ø 114-133)	147-0546	114-133	1.60	114-133
---	----------	---------	------	---------

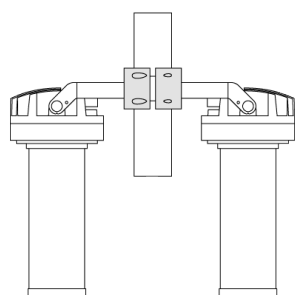
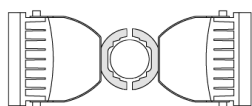

D1

## FLC230 LED [ZP]

Description	Référence	D1	Poids (kg)	D
TS1-2/M12 collier simple pour tube (Ø 76-89)	147-0543	76-89	1.40	76-89

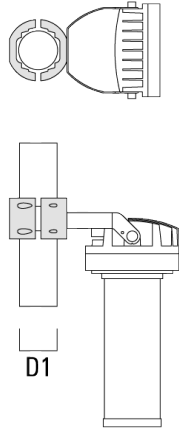

## Base à enterrer

Description	Référence	D1	D2	D3	D4	H1	H2	M1	Poids (kg)
Base à enterrer ESV4	300-0461	145	130	60	89	400	350	8	3.83



## WE-EF Switzerland AG

Himmelrichstrasse 6, 6003 Luzern - Téléphone: +41 22 752 49 94

info.switzerland@we-ef.com - [https://we-ef.com/ch\\_fr](https://we-ef.com/ch_fr)

Sous réserve de modifications techniques et d'erreurs. - Généré le 23/11/2024

## Collier pour mâts PC

Description	Référence	D1	Poids (kg)
PC1 76-89/60 collier simple (Ø 76-89)	139-2702	76-89	1.00

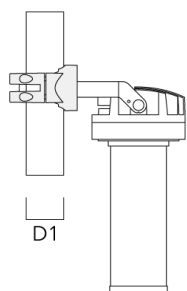
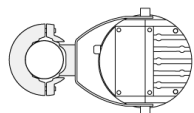

PC2 76-89/60 collier double pour tube (Ø 76-89)	139-2703	76-89	1.00
---	----------	-------	------

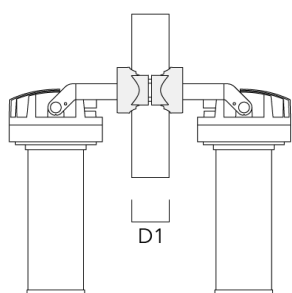
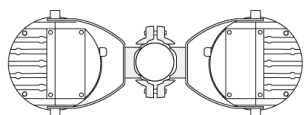

## FLC230 LED [ZP]

Description	Référence	D1	Poids (kg)
PC1 82-109/60 collier simple (Ø 82-109)	139-2704	82-109	1.10



PC2 82-109/60 collier double pour tube (Ø 82-109)	139-2705	82-109	1.10
---	----------	--------	------



## FLC230 LED [ZP]

Description	Référence	D1	Poids (kg)
PC1 102-114/60 collier simple (Ø 102-114)	139-2706	102-114	1.20



PC2 102-114/60 collier double pour tube (Ø 102-114)	139-2707	102-114	1.20
---	----------	---------	------

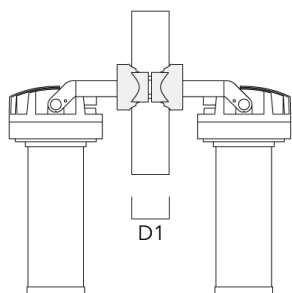

## FLC230 LED [ZP]

Description	Référence	D1	Poids (kg)
PC1 114-133/60 collier simple (Ø 144-133)	139-2708	114-133	1.40



PC2 114-133/60 collier double pour tube (Ø 114-133)	139-2709	114-133	1.40
---	----------	---------	------

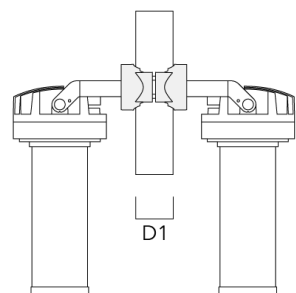

**Control****Eco Step Dim® Basic**

Description	Référence
Eco Step Dim® Basic LED	430-0001

**Eco Step Dim® Advanced**

Description	Référence
Eco Step Dim® Advanced LED	430-0002

**R2C Ready to Connect**

Description	Référence
R2C Ready to Connect (top)	430-0019