

102-1000

AFL130-ISP

we-ef



Description

Solar (ISP - integrated solar panel, fully independent). IP66, Class III. IK08. Marine-grade, die-cast aluminium alloy. 5CE superior corrosion protection including PCS hardware. CCG® Controlled Compression Gasket. Non-reflective flat safety glass cover, hinged. Integral D4i-certified electronic LED driver in Zhaga format. CAD-optimised optics for superior illumination and glare control. OLC® One LED Concept. Factory installed WE-EF LED circuit board (Zhaga Book 15 compliant). The luminaire is factory-sealed and does not need to be opened during installation. Flush installation of the solar module with the housing for a clean finish. Alignment of the solar panel only in combination with the luminaire Can be used as post top or side entry version. Specification at time of order is recommended. Spigot Ø 3" x 4" . Contact WE-EF direct or your local WE-EF sales representative for an individual solution designed to precisely meet your needs. Photometric files (IES, LDT) for light distributions [S70] [A61] [P66] with Backlight Shield on request.

Weight	7.00 lb
Light distribution	[A61] Type IV Very Short
Light source	LED-24/11W / 160 mA - 3000K
CRI	80
Power supply	electronic gear
LEDs	24
Rated input power	12 W
Nominal Lumen (lm)	
LED Lumen	77.9
Total Lumen	1870
Tj	85
Rated lumens (lm)	
LED Lumen	68.3
Total Lumen	1638.8
Ta	25

WE-EF LIGHTING USA, LLC

410-D Keystone Drive, 15086 Warrendale, PA 15086 - Phone: +1 724 742 0030
customersupport.usa@we-ef.com - <https://we-ef.com/us>
Subject to technical changes and errors. - Generated on 11/23/2024

102-1000

we-ef

AFL130-ISP

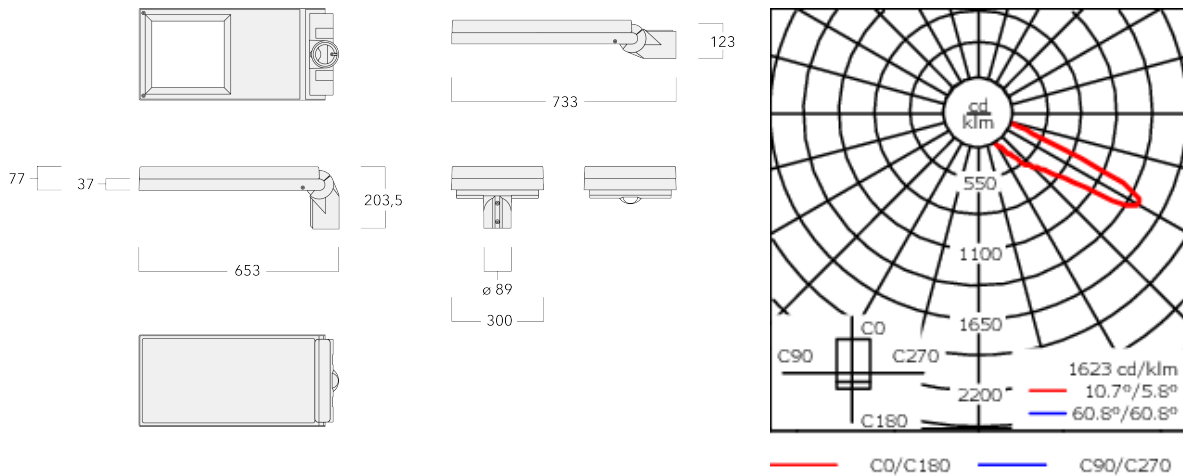

Specifications

Material description

Body	Marine-grade, die-cast aluminium alloy
Lens	Non-reflective safety glass lens
Colors	<ul style="list-style-type: none"> RAL9004 Black RAL9007 Grey Metallic RAL9016 White RAL8019 Dark Bronze
Gasket	CCG® Controlled Compression Gasket
Fasteners	PCS Polymer Coated Stainless Steel Hardware
Ingress protection	IP66
Impact resistance	IK08
Corrosion resistance	5CE
Windage	0.191 m ²

Electrical description

Power supply	220-240V / 50-60 Hz
Driver / Ballast	Integral EC electronic converter. DALI
Power factor	> 0.9
Surge protection	6/6kV, optional 10kV

WE-EF LIGHTING USA, LLC

410-D Keystone Drive, 15086 Warrendale, PA 15086 - Phone: +1 724 742 0030

customersupport.usa@we-ef.com - <https://we-ef.com/us>

Subject to technical changes and errors. - Generated on 11/23/2024

102-1000

we-ef

AFL130-ISP

Additional information

Lifetime Ta=25° L90B10 > 90000h

Energy efficiency class C-D (Light source)

WE-EF LIGHTING USA, LLC

410-D Keystone Drive, 15086 Warrendale, PA 15086 - Phone: +1 724 742 0030
customersupport.usa@we-ef.com - <https://we-ef.com/us>

Subject to technical changes and errors. - Generated on 11/23/2024

102-1000

AFL130-ISP

we-ef

Mounting Accessories

Adaptor

Description	Part ID
Adaptor AFL100	102-0392

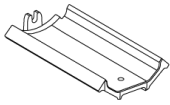

WE-EF LIGHTING USA, LLC

410-D Keystone Drive, 15086 Warrendale, PA 15086 - Phone: +1 724 742 0030
customersupport.usa@we-ef.com - <https://we-ef.com/us>

Subject to technical changes and errors. - Generated on 11/23/2024

Optical Accessories

Backlight shield

Description	Part ID	Additional information
LS180	430-0029	Glare Shield for backlight spill. Glare Shield factory-installed or available as retrofit kit. Suitable for [S61][S66][R61][P66][Q66][A61] lenses. Must be specified at time of ordering.

