

133-0361

SVL259 LED

we-ef



Description

IP55, Class I. Class II on request. IK10. Marine-grade, die-cast aluminium alloy. 5CE superior corrosion protection including PCS hardware. Silicone rubber gasket. Polycarbonate main lens. Two cable entries. Factory installed LED circuit board. Integral EC electronic converter. Optional 2200 K version available. To be specified at time of ordering.

A pre-installation blackout is available and recommended for mounting in concrete walls. To be ordered separately.

Weight	1.20 kg
Light distribution	diffused distribution
Light source	LED-6/6W / 350 mA - 4000 K
CRI	80
Power supply	EC
LEDs	6
Rated input power	7.5 W

Nominal Lumen (lm)

LED Lumen	170
Total Lumen	1020
Tj	85

Rated lumens (lm)

LED Lumen	6.8
Total Lumen	41.1
Ta	25

Fagerhult Lighting Ltd

33-34 Dolben Street, SE1 0UQ London, United Kingdom

<https://we-ef.com/uk>

Subject to technical changes and errors. - Generated on 23/11/2024

133-0361



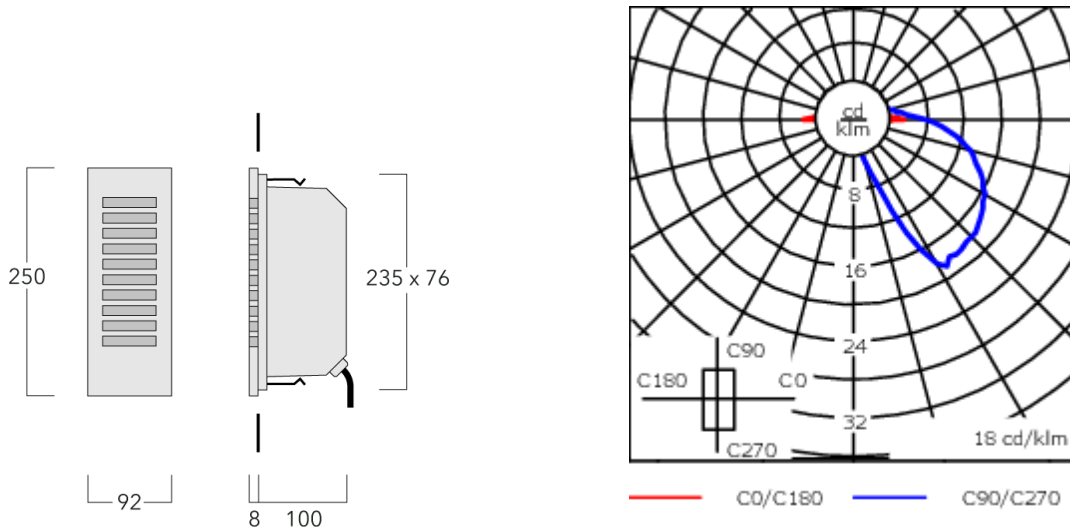

SVL259 LED

we-ef



Specifications

Material description

Body	Marine-grade die-cast aluminium alloy
Lens	Polycarbonate lens
Colours	 RAL9004 Signal black  RAL9006 White aluminium  RAL9007 Grey aluminium  RAL7016 Anthracite grey  RAL9016 Traffic white
Gasket	Silicone rubber gasket
Fasteners	PCS Polymer Coated Stainless Steel Hardware
Ingress protection	IP55
Impact resistance	IK10
Corrosion resistance	5CE

Electrical description

Power supply	220-240V / 50-60 Hz
Driver / Ballast	Integral EC electronic converter
Surge protection	1/2 kV

Additional information

Lifetime	Ta=25° L80B10 > 54000h
Energy efficiency class	C-D (Light source)

Fagerhult Lighting Ltd

33-34 Dolben Street, SE1 0UQ London, United Kingdom

<https://we-ef.com/uk>

Subject to technical changes and errors. - Generated on 23/11/2024

Mounting Accessories

Installation blackout

Description	Part ID	A	B	C1
Installation blackout BST25-II	133-0078	267	132	140

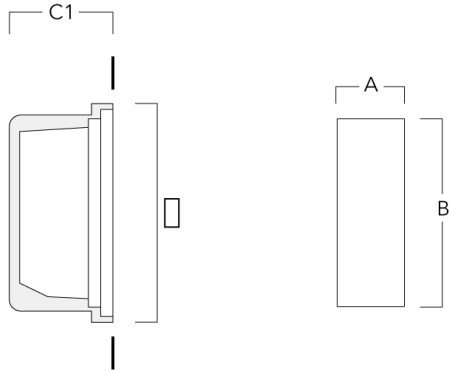

Installation blackout BST25-I	133-0076	267	132	130
-------------------------------	----------	-----	-----	-----

