

145-0037

we-ef

FLC121 LED - Wall bracket



Description

IP66. Class I. IK07. Marine-grade, die-cast aluminum alloy. 5CE superior corrosion protection including PCS hardware. Silicone CCG® Controlled Compression Gasket. Safety glass lens. CAD-optimized optics for superior illumination and glare control. Integral driver in thermally separated compartment. OLC® One LED Concept. Factory-installed LED circuit board. 0-10V Dimming comes standard with luminaire.

Knuckle permits 350° horizontal and 90° vertical aiming of optics.

Specify product with 7 Digit product code - Finish Color. Accessories, such as mounting, optical, and electrical, must be specified separately.

Example: XXX-XXXX-9004 (Black).

+ XXX-XXXX (Accessory 1)

Weight	6.40 lb
Light distribution	symmetric, medium beam [M]
Light source	LED-6/12W / 700 mA - 3000 K
CRI	80
Power supply	electronic gear
LEDs	6
Rated input power	14.5 W

Nominal Lumen (lm)

LED Lumen	290
Total Lumen	1740
Tj	85

Rated lumens (lm)

LED Lumen	252
Total Lumen	1511.8
Ta	25

WE-EF LIGHTING USA, LLC

410-D Keystone Drive, 15086 Warrendale, PA 15086 - Phone: +1 724 742 0030

customersupport.usa@we-ef.com - <https://we-ef.com/us>

Subject to technical changes and errors. - Generated on 11/23/2024

145-0037

we-ef

FLC121 LED - Wall bracket

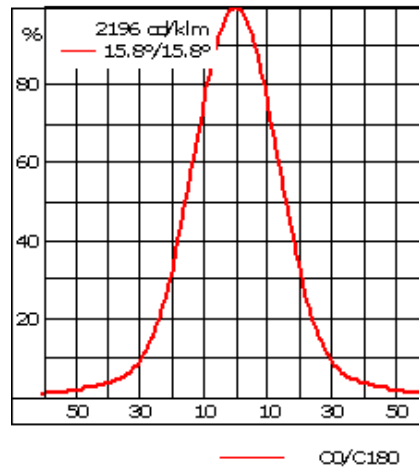
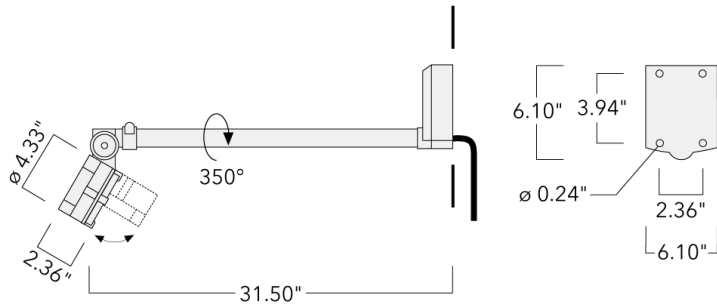

Specifications

Material description

Body	Marine-grade, all-aluminium construction
Lens	Clear tempered glass lens.
Colors	<div style="display: flex; flex-direction: column; gap: 5px;"> <div> RAL9004 Black</div> <div> RAL9007 Grey Metallic</div> <div> RAL9016 White</div> <div> RAL8019 Dark Bronze</div> </div>
Gasket	Silicone rubber gasket
Fasteners	PCS Polymer Coated Stainless Steel hardware
Ingress protection	IP55
Impact resistance	IK07
Corrosion resistance	5CE

Electrical description

Power supply	Integral [ECG] electronic 0-10 V dimmable driver in 120-277 universal voltage
Driver / Ballast	Integral EC electronic converter in thermally-separated compartment
Surge protection	Integral 10kV Surge Protector

WE-EF LIGHTING USA, LLC

410-D Keystone Drive, 15086 Warrendale, PA 15086 - Phone: +1 724 742 0030
customersupport.usa@we-ef.com - <https://we-ef.com/us>
Subject to technical changes and errors. - Generated on 11/23/2024

145-0037

we-ef

FLC121 LED - Wall bracket

Additional information

Lifetime	Ta=25°/40° L90B10 > 90000h
Other Color Temperatures	2700K, 3500K, 5000K and True Amber available on request.
Listings	ETL, UL-1598, CSA-C22.2#250.0. Suitable for Wet Locations.

WE-EF LIGHTING USA, LLC

410-D Keystone Drive, 15086 Warrendale, PA 15086 - Phone: +1 724 742 0030
customersupport.usa@we-ef.com - <https://we-ef.com/us>
Subject to technical changes and errors. - Generated on 11/23/2024

145-0037

FLC121 LED - Wall bracket

Optical Accessories

Snoot

Description	Part ID	A	C1
Snoot ET	145-0030	2.36"	4.72"



WE-EF LIGHTING USA, LLC

410-D Keystone Drive, 15086 Warrendale, PA 15086 - Phone: +1 724 742 0030
customersupport.usa@we-ef.com - <https://we-ef.com/us>

Subject to technical changes and errors. - Generated on 11/23/2024

145-0037

we-ef

FLC121 LED - Wall bracket

Linear spread lens

Description	Part ID	C1
IO-180-FLC121-LED	145-0050	3.19"



Softening Lens

Description	Part ID	C1
IO-360-FLC121-LED	145-0142	3.20



WE-EF LIGHTING USA, LLC

410-D Keystone Drive, 15086 Warrendale, PA 15086 - Phone: +1 724 742 0030
customersupport.usa@we-ef.com - <https://we-ef.com/us>
Subject to technical changes and errors. - Generated on 11/23/2024

145-0037

we-ef

FLC121 LED - Wall bracket

Honeycomb louvre

Description	Part ID	C1
IW-FLC121-LED	145-0143	3.20

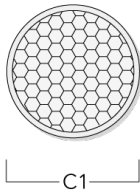

Wallwash lens

Description	Part ID	C1
IO-20-WW-FLC121-LED	145-0145	3.19"

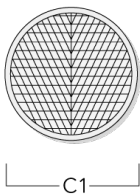

WE-EF LIGHTING USA, LLC

410-D Keystone Drive, 15086 Warrendale, PA 15086 - Phone: +1 724 742 0030
customersupport.usa@we-ef.com - <https://we-ef.com/us>
Subject to technical changes and errors. - Generated on 11/23/2024

FLC121 LED - Wall bracket

Glare shield

Description	Part ID	A	C1
Glare shield ES	145-9192	4.02	4.69

