

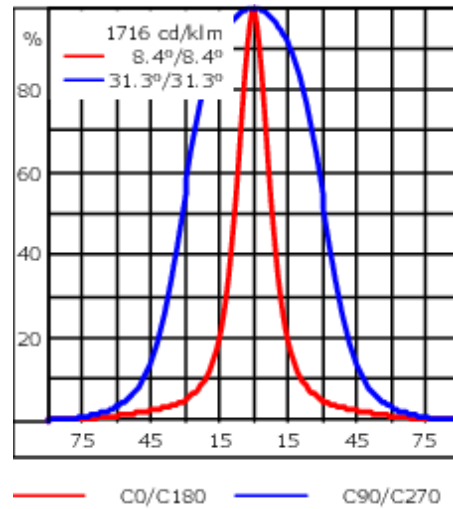

Description

IP66, Class I. IK07. Marine-grade, die-cast aluminium alloy. 5CE superior corrosion protection + primer including PCS hardware. Silicone CCG® Controlled Compression Gasket. Safety glass lens. Integral EC electronic converter in thermally separated compartment. CAD-optimised optics for superior illumination and glare control. OLC® One LED Concept. Factory installed LED circuit board. The luminaire is factory- sealed and does not need to be opened during the installation.

Weight	1.70 kg
Light distribution	linear spread, very narrow beam [EE]
Light source	LED-6/12W / 700 mA - 4000 K
CRI	80
Power supply	EC
LEDs	6
Rated input power	14.5 W
Nominal Lumen (lm)	
LED Lumen	310
Total Lumen	1860
Tj	85
Rated lumens (lm)	
LED Lumen	247
Total Lumen	1481.9
Ta	25

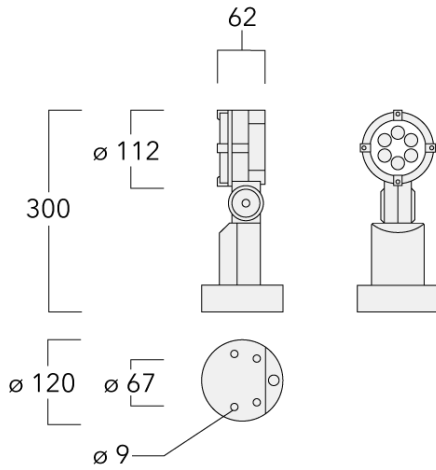

Specifications

Material description

Body	Marine-grade, die-cast aluminium alloy
Lens	Safety glass lens
Colours	<div style="display: flex; align-items: center;"> <div style="width: 20px; height: 15px; background-color: black; margin-right: 5px;"></div> RAL9004 Signal black </div> <div style="display: flex; align-items: center; margin-top: 5px;"> <div style="width: 20px; height: 15px; background-color: #cccccc; margin-right: 5px;"></div> RAL9006 White aluminium </div> <div style="display: flex; align-items: center; margin-top: 5px;"> <div style="width: 20px; height: 15px; background-color: #808080; margin-right: 5px;"></div> RAL9007 Grey aluminium </div>
Gasket	Silicone CCG® Controlled Compression Gasket
Fasteners	PCS Polymer Coated Stainless Steel Hardware (unpainted)
Ingress protection	IP66
Impact resistance	IK07
Corrosion resistance	5CE+Primer
Windage	0.025 m ²

Electrical description

Power supply	230V / 50 Hz
Driver / Ballast	Integral EC electronic converter in thermally-separated compartment

145-0056+145-0050

FLC121 LED #2

we-ef

Additional information

Lifetime Ta=40° L90B10 > 90000h

Warranty The product is supplied with 10-year warranty. Please refer to the LED Warranty Statement located on www.we-ef.com for further details.

WE-EF LIGHTING Pty Ltd

6/13 Downard Street, 3195 Braeside, Victoria - Phone: +61 3 8587 0444 - Fax: +61 3 8587 0499

info.australia@we-ef.com - <https://we-ef.com/aus>

Subject to technical changes and errors. - Generated on 23/11/2024

Optical Accessories

Snoot

Description	Part ID	A	C1
Snoot ET	145-0030	60	120

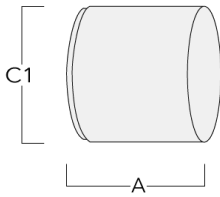

Linear spread lens

Description	Part ID	C1
IO-180-FLC121-LED	145-0050	81

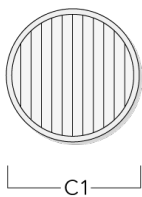

FLC121 LED #2

Surface wash lens

Description	Part ID	C1
IO-360-FLC121-LED	145-9390	81

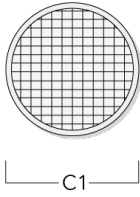

Honeycomb louvre

Description	Part ID	C1
IW-FLC121-LED	145-0143	81

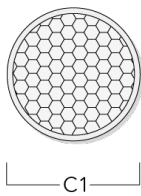

FLC121 LED #2

Wallwash lens

Description	Part ID	C1
IO-20-WW-FLC121-LED	145-0145	81

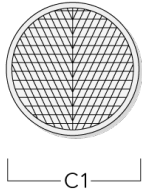

Glare shield

Description	Part ID	A	C1
Glare shield ES	145-9192	102	119

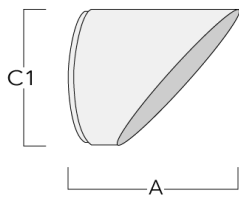

145-0056+145-0050

we-ef

FLC121 LED #2

Linear louvre

Description	Part ID	C1
Linear louvre IL	145-9171	81



Mounting Accessories

Pipe clamp SP

Description	Part ID	D1	Weight (kg)	D
SP1-2/M8 Pole clamp, single (Ø 76-89)	146-0246	76-89	1.20	76-89

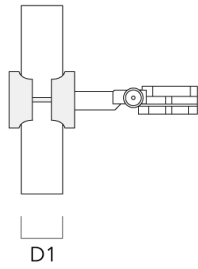

SP2-2/M8 Pole clamp, double (Ø 38-60)	146-0247	38-60	1	38-60
---------------------------------------	----------	-------	---	-------

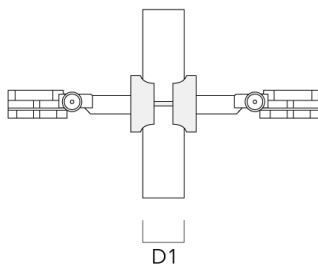

FLC121 LED #2

Description	Part ID	D1	Weight (kg)	D
SP2-2/M8 Pole clamp, double (Ø 76-89)	146-0248	76-89	1.20	76-89

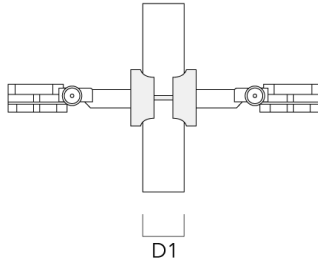

SP1-2/M8 Pole clamp, single (Ø 38-60)	146-0245	38-60	1	38-66
---------------------------------------	----------	-------	---	-------

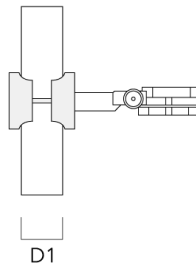

FLC121 LED #2

Short post EM

Description	Part ID	D1	D2	H1	M1	Weight (kg)
EM1-2/M8	146-0253	160	130	200	9	1.10

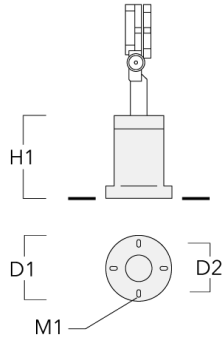

Planted root

Description	Part ID	D1	D2	D3	D4	H1	H2	M1	T1	T2	Weight (kg)
Planted root ESV4	300-0461-AP	150	130	60	89	400	350	8	200	50 x 100	3.85

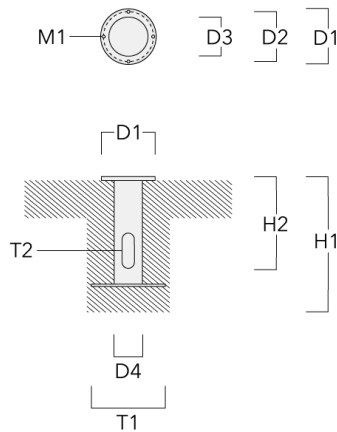

FLC121 LED #2

Ground spike EF

Description	Part ID	H1	Weight (kg)
Ground spike EF1-2/M8	146-0251	270	0.40

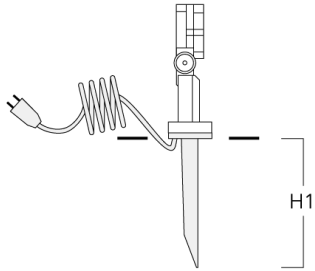

Junction box JB1

Description	Part ID	D1	D2	M1	Weight (kg)
JB1 Junction box	310-9000	135	67	9	1.6

