

Description

IP66, Class I. IK07. Marine-grade, die-cast aluminium alloy. 5CE superior corrosion protection + primer including PCS hardware. Safety glass lens. Silicone CCG® Controlled Compression Gasket. Luminaire is factory-sealed and does not need to be opened during installation. Integral EC electronic converter in thermally-separated compartment. Advanced thermal management protects LEDs while optimising lumens output. CAD-optimised optics for superior illumination and glare control. OLC® One LED Concept.

Including 0.4 m of flexible cable enclosed in a stainless conduit, in-line connector and mounting clamp for installation to RAIL66 mounting system.

2700 K option available on request.

If ordering a fitting to be installed on an existing rail, please confirm the rail version with your local distributor or our customer excellence team as connectors vary.

Weight	2.60 kg
Light distribution	symmetric, very narrow beam, sharp cut-off [EES]
Light source	LED-6/12W / 700 mA - 3000 K
CRI	80
Power supply	EC
LEDs	6
Rated input power	14.5 W

Nominal Lumen (lm)

LED Lumen	290
Total Lumen	1740
Tj	85

Rated lumens (lm)

LED Lumen	248.8
Total Lumen	1492.9
Ta	25

145-9515

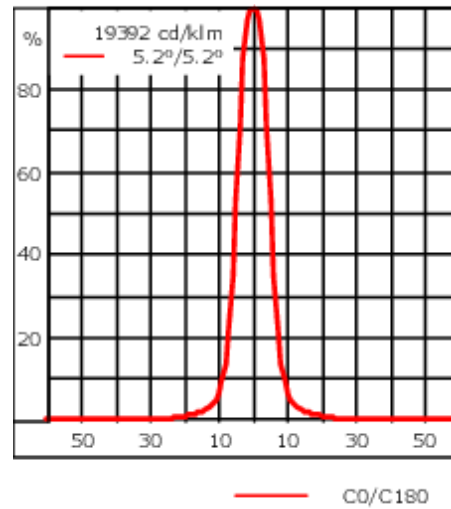

FLD121 LED RAIL66

we-ef



Specifications

Material description

Body	Marine-grade, die-cast aluminium alloy
Lens	Safety glass lens
Colours	 RAL9004 Signal black  RAL9006 White aluminium  RAL9007 Grey aluminium
Gasket	Silicone CCG® Controlled Compression Gasket
Fasteners	PCS Polymer Coated Stainless Steel Hardware (unpainted)
Ingress protection	IP66
Impact resistance	IK07
Corrosion resistance	5CE+Primer

Electrical description

Power supply	230V / 50 Hz
Driver / Ballast	Integral EC electronic converter in thermally-separated compartment

Additional information

Lifetime	Ta=40° L90B10 > 90000h
Warranty	The product is supplied with 10-year warranty. Please refer to the LED Warranty Statement located on www.we-ef.com for further details.

WE-EF LIGHTING Pty Ltd

6/13 Downard Street, 3195 Braeside, Victoria - Phone: +61 3 8587 0444 - Fax: +61 3 8587 0499

info.australia@we-ef.com - <https://we-ef.com/aus>

Subject to technical changes and errors. - Generated on 23/11/2024

Optical Accessories

Wallwash lens

Description	Part ID	C1
Wallwash lens IO-20	145-9479	97

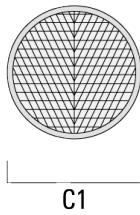

Optical Adaptor

Description	Part ID	A	C1
External optical adaptor EA	145-9530	57	109

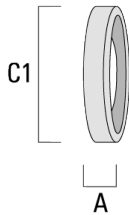

Glare shield

Description	Part ID	A	C1
Glare shield ES	145-9531	57	109

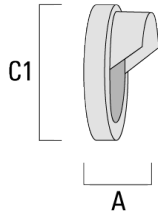

Snoot

Description	Part ID	A	C1
Snoot ET	145-9532	57	109

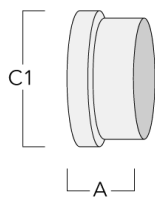

Linear spread lens

Description	Part ID	C1
EO-180	145-9533	101

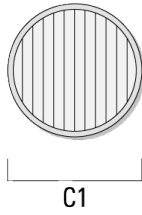

Surface wash lens

Description	Part ID	C1
EO-360	145-9534	101

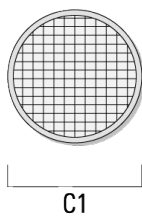

Mounting Accessories

Universal

Description	Part ID	C1	C2	H1	M1	Weight (kg)	L1	L2
2 Mains outlets (L=1150)	310-9200	75	30	200	12	5.90	1150	1045

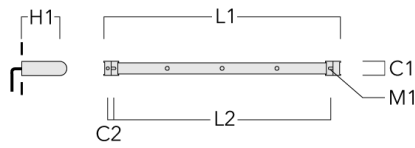

3 Mains outlets (L=1150)	310-9202	75	30	200	12	5.90	1150	1045
--------------------------	----------	----	----	-----	----	------	------	------

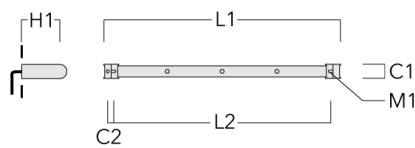

FLD121 LED RAIL66

Description	Part ID	C1	C2	H1	M1	Weight (kg)	L1	L2
3 Mains outlets (L=1650)	310-9210	75	30	200	12	7.20	1650	1545

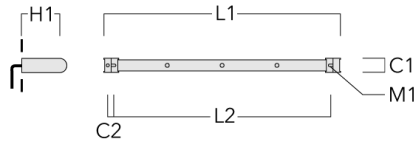

4 Mains outlets (L=1650)	310-9212	75	30	200	12	7.20	1650	1545
--------------------------	----------	----	----	-----	----	------	------	------

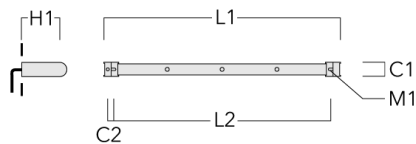

FLD121 LED RAIL66

Description	Part ID	C1	C2	H1	M1	Weight (kg)	L1	L2
4 Mains outlets (L=2150)	310-9220	75	30	200	12	8.50	2150	2045

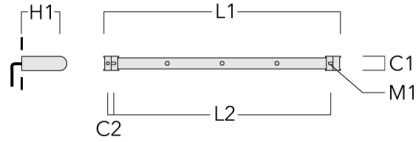

6 Mains outlets (L=2150)	310-9222	75	30	200	12	8.50	2150	2045
--------------------------	----------	----	----	-----	----	------	------	------

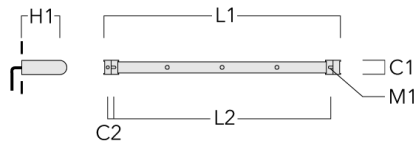

Flat Surface Fitters

Description	Part ID	C1	C2	D1	D2	L	M1	Weight (kg)
Surface fitters (pair)	310-9290	20	30	180	140	1070	9	1.70

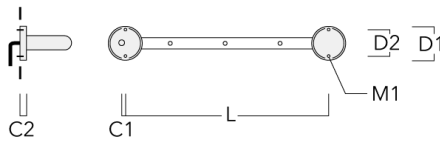

Column Fitters

Description	Part ID	C1	C2	L	M1	Weight (kg)
Column fitters (pair)	310-9294	30	100	1115	12	0.90

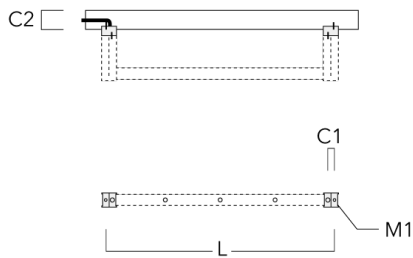

Cantilever

Description	Part ID	C1	C2	C3	H1	M1	Weight (kg)	L1	L2
2 Mains outlets (L=1150)	310-9230	220	120	60	600	13	12	1150	1070

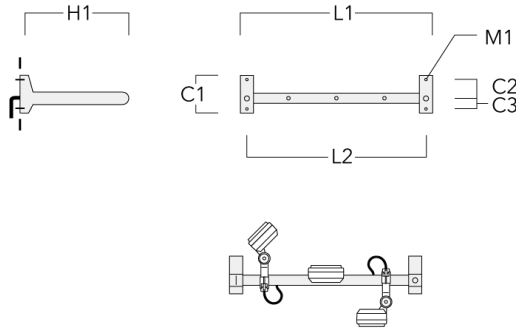

3 Mains outlets (L=1150)	310-9232	220	120	60	600	13	12	1150	1070
--------------------------	----------	-----	-----	----	-----	----	----	------	------

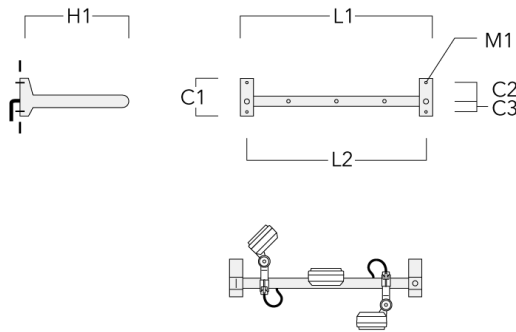

FLD121 LED RAIL66

Description	Part ID	C1	C2	C3	H1	M1	Weight (kg)	L1	L2
3 Mains outlets (L=1650)	310-9240	220	120	60	600	13	13.30	1650	1570

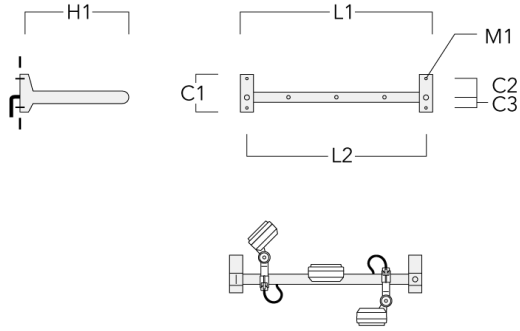

4 Mains outlets (L=1650)	310-9242	220	120	60	600	13	13.30	1650	1570
--------------------------	----------	-----	-----	----	-----	----	-------	------	------

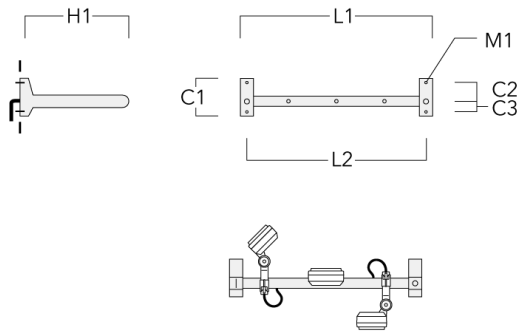

FLD121 LED RAIL66

Description	Part ID	C1	C2	C3	H1	M1	Weight (kg)	L1	L2
4 Mains outlets (L=2150)	310-9250	220	120	60	600	13	14.60	2150	2070

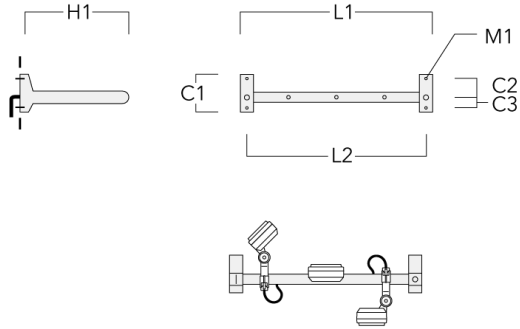

6 Mains outlets (L=2150)	310-9252	220	120	60	600	13	14.60	2150	2070
--------------------------	----------	-----	-----	----	-----	----	-------	------	------

