



Description

IP66, Class I. IK07. Marine-grade, die-cast aluminium alloy. 5CE superior corrosion protection including PCS hardware. Silicone CCG® Controlled Compression Gasket. Safety glass lens. Integral EC electronic converter in thermally separated compartment. CAD-optimised optics for superior illumination and glare control. OLC® One LED Concept. Factory installed LED circuit board.

Including 0,4 m of flexible cable enclosed in stainless conduit, in-line connector and mounting clamp for installation to RAIL66 mounting system.

| | |
|--------------------|------------------------------|
| Weight | 3.00 kg |
| Light distribution | symmetric, wide beam [B] |
| Light source | LED-12/24W / 700 mA - 4000 K |
| CRI | 80 |
| Power supply | EC |
| LEDs | 12 |
| Rated input power | 27 W |

Nominal Lumen (lm)

| | |
|-------------|------|
| LED Lumen | 310 |
| Total Lumen | 3720 |
| Tj | 85 |

Rated lumens (lm)

| | |
|-------------|-------|
| LED Lumen | 204.6 |
| Total Lumen | 2455 |
| Ta | 25 |

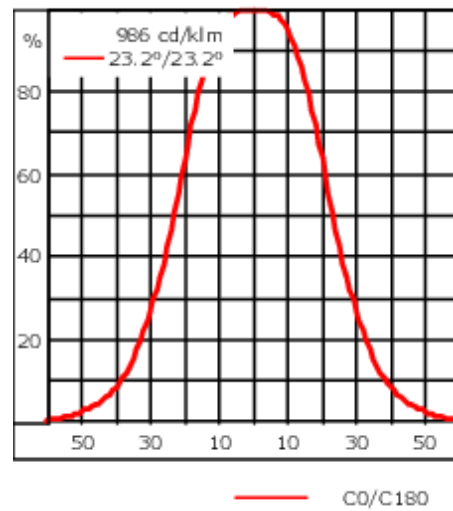
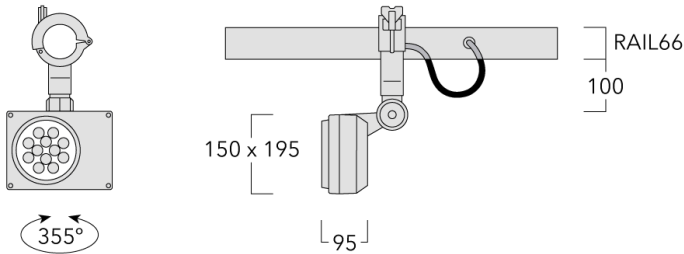

Specifications

Material description

| | |
|----------------------|--|
| Body | Marine-grade, die-cast aluminium alloy |
| Lens | Safety glass lens |
| Colours | <div style="display: flex; align-items: center;"> <div style="width: 20px; height: 15px; background-color: black; margin-right: 5px;"></div> <div>RAL9004 Signal black</div> </div> <div style="display: flex; align-items: center; margin-top: 5px;"> <div style="width: 20px; height: 15px; background-color: #cccccc; margin-right: 5px;"></div> <div>RAL9006 White aluminium</div> </div> <div style="display: flex; align-items: center; margin-top: 5px;"> <div style="width: 20px; height: 15px; background-color: #808080; margin-right: 5px;"></div> <div>RAL9007 Grey aluminium</div> </div> <div style="display: flex; align-items: center; margin-top: 5px;"> <div style="width: 20px; height: 15px; background-color: #333333; margin-right: 5px;"></div> <div>RAL7016 Anthracite grey</div> </div> <div style="display: flex; align-items: center; margin-top: 5px;"> <div style="width: 20px; height: 15px; background-color: #e0e0e0; margin-right: 5px;"></div> <div>RAL9016 Traffic white</div> </div> |
| Gasket | Silicone rubber gasket |
| Fasteners | PCS Polymer Coated Stainless Steel Hardware |
| Ingress protection | IP66 |
| Impact resistance | IK07 |
| Corrosion resistance | 5CE |

Electrical description

| | |
|------------------|---|
| Power supply | 220-240V / 50-60 Hz |
| Driver / Ballast | Integral EC electronic converter in thermally-separated compartment |
| Surge protection | 1/2 kV |

Additional information

| | |
|-------------------------|------------------------|
| Lifetime | Ta=25° L90B10 > 90000h |
| Energy efficiency class | C-D (Light source) |

WE-EF LEUCHTEN GmbH

Töpinger Straße 16, 29646 Bispingen, Germany - Phone: +49 5194 909-0
 info@we-ef.com - <https://we-ef.com>

Subject to technical changes and errors. - Generated on 23/11/2024

Optical Accessories**Glare shield**

| Description | Part ID | A | C1 |
|-----------------|----------|----|-----|
| Glare shield ES | 145-9571 | 70 | 134 |

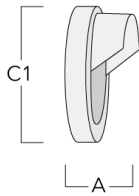
**Snoot**

| Description | Part ID | A | C1 |
|-------------|----------|----|-----|
| Snoot ET | 145-9572 | 70 | 134 |

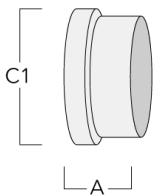

FLD131 LED RAIL66

Linear spread lens

| Description | Part ID | C1 |
|-------------------|----------|-----|
| IO-180-FLD131-LED | 145-9575 | 125 |



Flood lens

| Description | Part ID | C1 |
|-------------------|----------|-----|
| IO-360-FLD131-LED | 145-9576 | 125 |

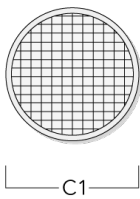

Mounting Accessories

Universal

| Description | Part ID | C1 | C2 | H1 | M1 | Weight (kg) | L1 | L2 |
|--------------------------|----------|----|----|-----|----|-------------|------|------|
| 2 Mains outlets (L=1150) | 310-9200 | 75 | 30 | 200 | 12 | 5.90 | 1150 | 1045 |

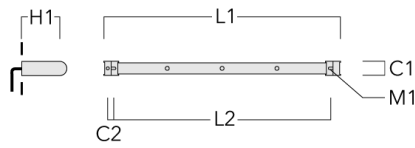

| | | | | | | | | |
|--------------------------|----------|----|----|-----|----|------|------|------|
| 3 Mains outlets (L=1150) | 310-9202 | 75 | 30 | 200 | 12 | 5.90 | 1150 | 1045 |
|--------------------------|----------|----|----|-----|----|------|------|------|

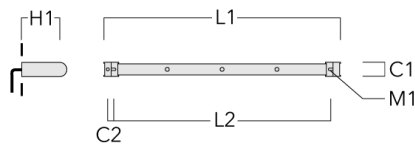

FLD131 LED RAIL66

| Description | Part ID | C1 | C2 | H1 | M1 | Weight (kg) | L1 | L2 |
|--------------------------|----------|----|----|-----|----|-------------|------|------|
| 3 Mains outlets (L=1650) | 310-9210 | 75 | 30 | 200 | 12 | 7.20 | 1650 | 1545 |

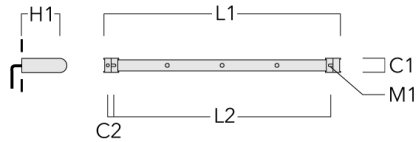

| | | | | | | | | |
|--------------------------|----------|----|----|-----|----|------|------|------|
| 4 Mains outlets (L=1650) | 310-9212 | 75 | 30 | 200 | 12 | 7.20 | 1650 | 1545 |
|--------------------------|----------|----|----|-----|----|------|------|------|

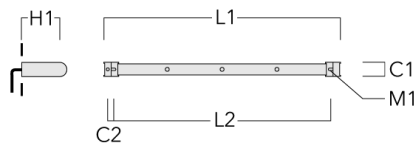

FLD131 LED RAIL66

| Description | Part ID | C1 | C2 | H1 | M1 | Weight (kg) | L1 | L2 |
|--------------------------|----------|----|----|-----|----|-------------|------|------|
| 4 Mains outlets (L=2150) | 310-9220 | 75 | 30 | 200 | 12 | 8.50 | 2150 | 2045 |



| | | | | | | | | |
|--------------------------|----------|----|----|-----|----|------|------|------|
| 6 Mains outlets (L=2150) | 310-9222 | 75 | 30 | 200 | 12 | 8.50 | 2150 | 2045 |
|--------------------------|----------|----|----|-----|----|------|------|------|



Flat Surface Fitters

| Description | Part ID | C1 | C2 | D1 | D2 | L | M1 | Weight (kg) |
|------------------------|----------|----|----|-----|-----|------|----|-------------|
| Surface fitters (pair) | 310-9290 | 20 | 30 | 180 | 140 | 1070 | 9 | 1.70 |

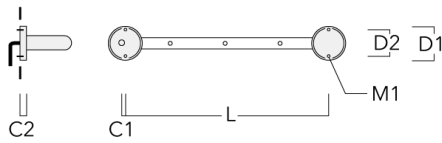

Column Fitters

| Description | Part ID | C1 | C2 | L | M1 | Weight (kg) |
|-----------------------|----------|----|-----|------|----|-------------|
| Column fitters (pair) | 310-9294 | 30 | 100 | 1115 | 12 | 0.90 |

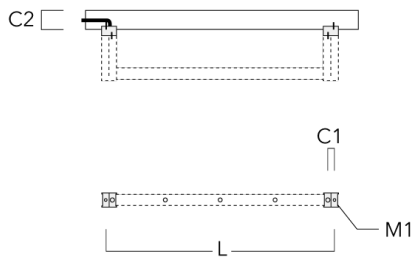

Cantilever

| Description | Part ID | C1 | C2 | C3 | H1 | M1 | Weight (kg) | L1 | L2 |
|--------------------------|----------|-----|-----|----|-----|----|-------------|------|------|
| 2 Mains outlets (L=1150) | 310-9230 | 220 | 120 | 60 | 600 | 13 | 12 | 1150 | 1070 |

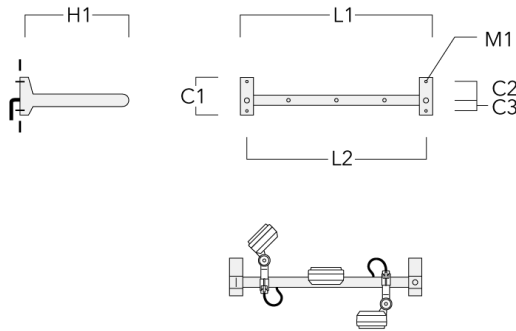

| | | | | | | | | | |
|--------------------------|----------|-----|-----|----|-----|----|----|------|------|
| 3 Mains outlets (L=1150) | 310-9232 | 220 | 120 | 60 | 600 | 13 | 12 | 1150 | 1070 |
|--------------------------|----------|-----|-----|----|-----|----|----|------|------|

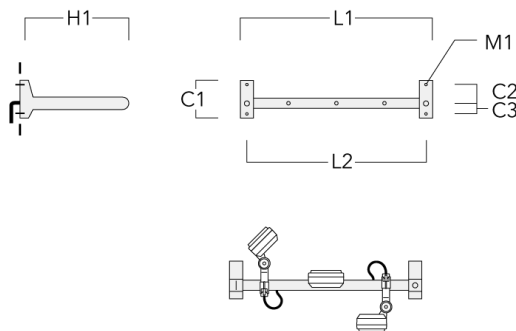

FLD131 LED RAIL66

| Description | Part ID | C1 | C2 | C3 | H1 | M1 | Weight (kg) | L1 | L2 |
|--------------------------|----------|-----|-----|----|-----|----|-------------|------|------|
| 3 Mains outlets (L=1650) | 310-9240 | 220 | 120 | 60 | 600 | 13 | 13.30 | 1650 | 1570 |

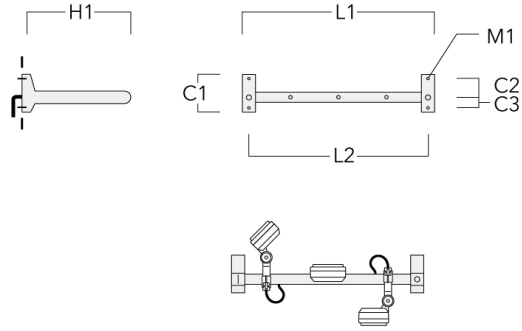

| | | | | | | | | | |
|--------------------------|----------|-----|-----|----|-----|----|-------|------|------|
| 4 Mains outlets (L=1650) | 310-9242 | 220 | 120 | 60 | 600 | 13 | 13.30 | 1650 | 1570 |
|--------------------------|----------|-----|-----|----|-----|----|-------|------|------|

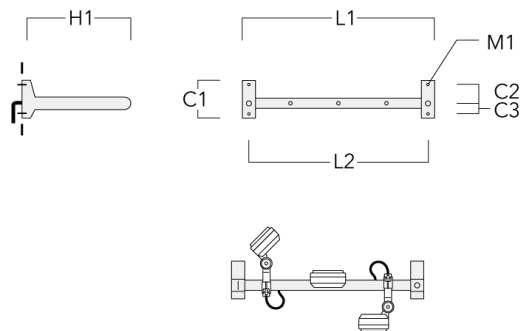

FLD131 LED RAIL66

| Description | Part ID | C1 | C2 | C3 | H1 | M1 | Weight (kg) | L1 | L2 |
|--------------------------|----------|-----|-----|----|-----|----|-------------|------|------|
| 4 Mains outlets (L=2150) | 310-9250 | 220 | 120 | 60 | 600 | 13 | 14.60 | 2150 | 2070 |

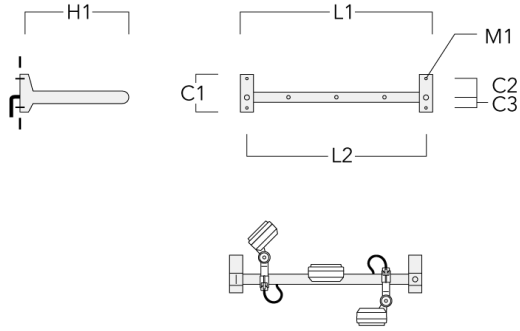

| | | | | | | | | | |
|--------------------------|----------|-----|-----|----|-----|----|-------|------|------|
| 6 Mains outlets (L=2150) | 310-9252 | 220 | 120 | 60 | 600 | 13 | 14.60 | 2150 | 2070 |
|--------------------------|----------|-----|-----|----|-----|----|-------|------|------|

