

145-9791

FLD111 LED #3

we-ef



Description

IP66, Class I. IK07. Marine-grade, die-cast aluminium alloy. 5CE superior corrosion protection including PCS hardware. Silicone CCG_R_ Controlled Compression Gasket. Safety glass lens. Integral EC electronic converter in thermally separated compartment. CAD-optimised optics for superior illumination and glare control. OLC_R_ One LED Concept. Factory installed LED circuit board. The luminaire is factory-sealed and does not need to be opened during the installation. Optional 2200 K version available, except version [A20]. To be specified at time of ordering.

Weight	1.60 kg
Light distribution	symmetric, medium beam [M]
Light source	LED-3/6W / 700 mA - 3000 K
CRI	80
Power supply	EC
LEDs	3
Rated input power	7.5 W
Nominal Lumen (lm)	
LED Lumen	290
Total Lumen	870
Tj	85
Rated lumens (lm)	
LED Lumen	232.1
Total Lumen	696.3
Ta	25

WE-EF LIGHTING Pty Ltd

6/13 Downard Street, 3195 Braeside, Victoria - Phone: +61 3 8587 0444 - Fax: +61 3 8587 0499

info.australia@we-ef.com - <https://we-ef.com/aus>

Subject to technical changes and errors. - Generated on 23/11/2024

145-9791

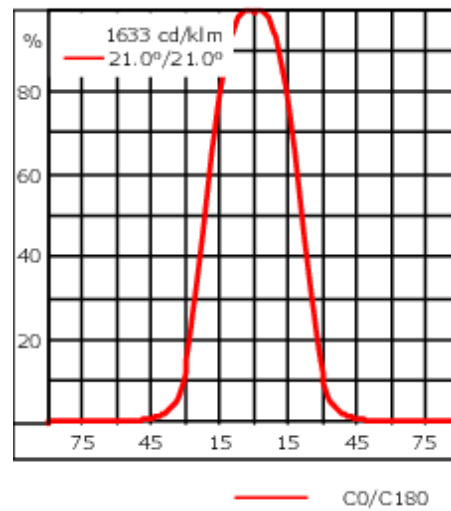

FLD111 LED #3

we-ef



Specifications

Material description

Body	Marine-grade, die-cast aluminium alloy
Lens	Safety glass lens
Colours	 RAL9004 Signal black  RAL9006 White aluminium  RAL9007 Grey aluminium
Gasket	Silicone CCG® Controlled Compression Gasket
Fasteners	PCS Polymer Coated Stainless Steel Hardware (unpainted)
Ingress protection	IP66
Impact resistance	IK07
Corrosion resistance	5CE+Primer

Electrical description

Power supply	230V / 50 Hz
Driver / Ballast	Integral EC electronic converter in thermally-separated compartment

Additional information

Lifetime	Ta=40° L90B10 > 90000h
Warranty	The product is supplied with 10-year warranty. Please refer to the LED Warranty Statement located on www.we-ef.com for further details.

WE-EF LIGHTING Pty Ltd

6/13 Downard Street, 3195 Braeside, Victoria - Phone: +61 3 8587 0444 - Fax: +61 3 8587 0499

info.australia@we-ef.com - <https://we-ef.com/aus>

Subject to technical changes and errors. - Generated on 23/11/2024

145-9791

FLD111 LED #3

we-ef

Mounting Accessories

Ground spike EF

Description	Part ID	H1	Weight (kg)
Ground spike EF1-2/M5 for FLD100	145-9196	270	1.00



145-9791

FLD111 LED #3

we-ef

Optical Accessories

Optical Adaptor

Description	Part ID	A	C1
External optical adaptor EA	145-9830	53	91

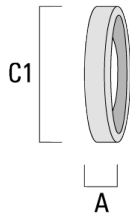

Glare shield

Description	Part ID	A	C1
Glare shield ES	145-9831	53	91

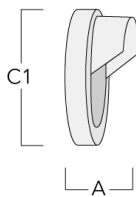

WE-EF LIGHTING Pty Ltd

6/13 Downard Street, 3195 Braeside, Victoria - Phone: +61 3 8587 0444 - Fax: +61 3 8587 0499

info.australia@we-ef.com - <https://we-ef.com/aus>

Subject to technical changes and errors. - Generated on 23/11/2024

145-9791

FLD111 LED #3

we-ef

Snoot

Description	Part ID	A	C1
Snoot ET	145-9832	53	91

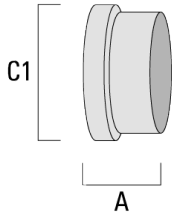

Linear spread lens

Description	Part ID	C1
EO-180-FLD111-LED	145-9833	68

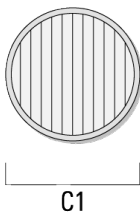

WE-EF LIGHTING Pty Ltd

6/13 Downard Street, 3195 Braeside, Victoria - Phone: +61 3 8587 0444 - Fax: +61 3 8587 0499

info.australia@we-ef.com - <https://we-ef.com/aus>

Subject to technical changes and errors. - Generated on 23/11/2024

145-9791

FLD111 LED #3

we-ef

Surface wash lens

Description	Part ID	C1
EO-360-FLD111-LED	145-9834	68



Wallwash lens

Description	Part ID	C1
Wallwash lens IO-20	145-9846	71

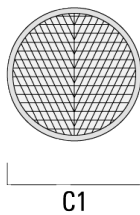

WE-EF LIGHTING Pty Ltd

6/13 Downard Street, 3195 Braeside, Victoria - Phone: +61 3 8587 0444 - Fax: +61 3 8587 0499

info.australia@we-ef.com - <https://we-ef.com/aus>

Subject to technical changes and errors. - Generated on 23/11/2024