

145-9791

FLD111 LED Surface mounted

we-ef



Description

IP66, Class I. IK07. Marine-grade, die-cast aluminium alloy. 5CE superior corrosion protection including PCS hardware. Safety glass lens. Silicone CCG® Controlled Compression Gasket.

Integral EC electronic converter in thermally-separated compartment. Advanced thermal management protects LEDs while optimising lumens output. CAD-optimised optics for superior illumination and glare control. OLC® One LED Concept. Optional 2200 K version available. To be specified at time of ordering.

Weight	1.60 kg
Light distribution	symmetric, medium beam [M]
Light source	LED-3/6W / 700 mA - 3000 K
CRI	80
Power supply	EC
LEDs	3
Rated input power	7.5 W
Nominal Lumen (lm)	
LED Lumen	290
Total Lumen	870
Tj	85
Rated lumens (lm)	
LED Lumen	232.1
Total Lumen	696.3
Ta	25

WE-EF LIGHTING (Thailand) Co., Ltd.

57 Moo 5, Kingkaew Rd., Bangplee, 10540 Samutprakarn - Phone: +66 2 738 96 20 - Fax: +66 2 738 96 29

<https://we-ef.com/asia>

Subject to technical changes and errors. - Generated on 23/10/2024

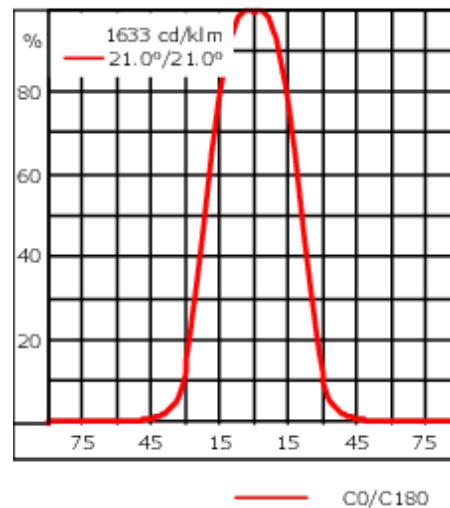

Specifications

Material description

Body	Marine-grade, die-cast aluminium alloy
Lens	Safety glass lens
Colours	<div style="display: flex; align-items: center;"> <div style="width: 20px; height: 15px; background-color: black; margin-right: 5px;"></div> RAL9004 Signal black </div> <div style="display: flex; align-items: center; margin-top: 5px;"> <div style="width: 20px; height: 15px; background-color: #808080; margin-right: 5px;"></div> RAL9007 Grey aluminium </div> <div style="display: flex; align-items: center; margin-top: 5px;"> <div style="width: 20px; height: 15px; background-color: #404040; margin-right: 5px;"></div> RAL7016 Anthracite grey </div> <div style="display: flex; align-items: center; margin-top: 5px;"> <div style="width: 20px; height: 15px; background-color: #e0e0e0; margin-right: 5px;"></div> RAL9016 Traffic white </div>
Gasket	Silicone CCG® Controlled Compression Gasket
Fasteners	PCS hardware
Ingress protection	IP66
Impact resistance	IK07
Corrosion resistance	5CE

Electrical description

Power supply	220-240V / 50-60 Hz
Driver / Ballast	Integral EC electronic converter in thermally-separated compartment

Additional information

Lifetime	T _a =25° L90B10 > 90000h
----------	-------------------------------------

Mounting Accessories

Ground spike

Description	Part ID	H1	Weight (kg)
Ground spike EF1 (including cable and plug)	145-9196	270	1.00



Ground spike EF1 (without cable and plug)	145-9198	270	0.40
---	----------	-----	------



Short post

WE-EF LIGHTING (Thailand) Co., Ltd.

57 Moo 5, Kingkaew Rd., Bangplee, 10540 Samutprakarn - Phone: +66 2 738 96 20 - Fax: +66 2 738 96 29

<https://we-ef.com/asia>

Subject to technical changes and errors. - Generated on 23/10/2024

145-9791

we-ef

FLD111 LED Surface mounted

Description	Part ID	Weight (kg)
Short post EM1-2/M8 for FLB141	146-0253	1.70

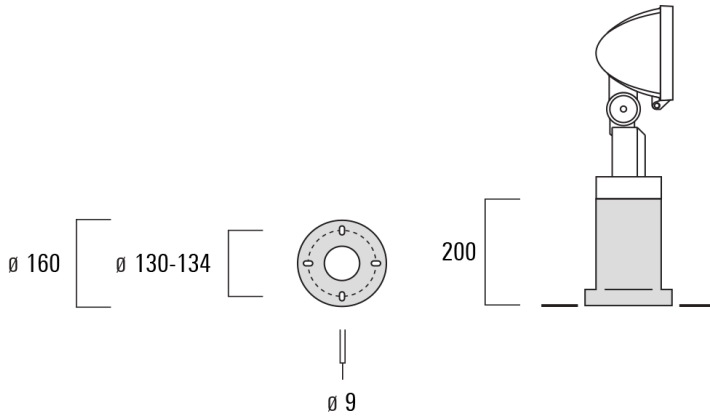

WE-EF LIGHTING (Thailand) Co., Ltd.

57 Moo 5, Kingkaew Rd., Bangplee, 10540 Samutprakarn - Phone: +66 2 738 96 20 - Fax: +66 2 738 96 29

<https://we-ef.com/asia>

Subject to technical changes and errors. - Generated on 23/10/2024

Optical Accessories

Optical Adaptor

Description	Part ID	A	C1
External optical adaptor EA	145-9830	53	91

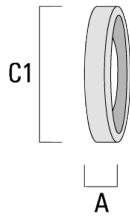

Glare shield

Description	Part ID	A	C1
Glare shield ES	145-9831	53	91

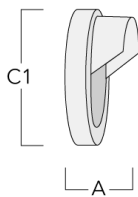

Snoot

145-9791

we-ef

FLD111 LED Surface mounted

Description	Part ID	A	C1
Snoot ET	145-9832	53	91

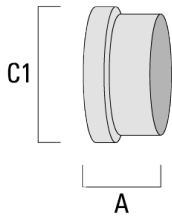

Linear spread lens

Description	Part ID	C1
Linear spread lens EO-180	145-9833	68

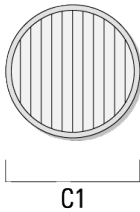

Flood lens

WE-EF LIGHTING (Thailand) Co., Ltd.

57 Moo 5, Kingkaew Rd., Bangplee, 10540 Samutprakarn - Phone: +66 2 738 96 20 - Fax: +66 2 738 96 29

<https://we-ef.com/asia>

Subject to technical changes and errors. - Generated on 23/10/2024

FLD111 LED Surface mounted

Description	Part ID	C1
Flood lens EO-360	145-9834	68

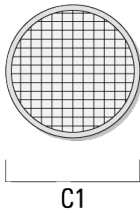

Wallwash lens

Description	Part ID	C1
Wallwash lens IO-20	145-9846	71

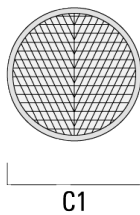

145-9791

FLD111 LED Surface mounted

WE-EF LIGHTING (Thailand) Co., Ltd.

57 Moo 5, Kingkaew Rd., Bangplee, 10540 Samutprakarn

Phone: +66 2 738 96 20

Fax: +66 2 738 96 29

<https://we-ef.com/asia>

Subject to technical changes and errors.

Generated on 23/10/2024