

145-9793

FLD111 LED #3

**we-ef**



### Description

IP66, Class I. IK07. Marine-grade, die-cast aluminium alloy. 5CE superior corrosion protection including PCS hardware. Silicone CCG\_R\_ Controlled Compression Gasket. Safety glass lens. Integral EC electronic converter in thermally separated compartment. CAD-optimised optics for superior illumination and glare control. OLC\_R\_ One LED Concept. Factory installed LED circuit board. The luminaire is factory-sealed and does not need to be opened during the installation. Optional 2200 K version available, except version [A20]. To be specified at time of ordering.

Weight	1.60 kg
Light distribution	symmetric, very narrow beam, sharp cut-off [EES]
Light source	LED-3/6W / 700 mA - 3000 K
CRI	80
Power supply	EC
LEDs	3
Rated input power	7.5 W
<b>Nominal Lumen (lm)</b>	
LED Lumen	290
Total Lumen	870
Tj	85
<b>Rated lumens (lm)</b>	
LED Lumen	233.6
Total Lumen	700.7
Ta	25

### WE-EF LIGHTING Pty Ltd

6/13 Downard Street, 3195 Braeside, Victoria - Phone: +61 3 8587 0444 - Fax: +61 3 8587 0499

info.australia@we-ef.com - <https://we-ef.com/aus>

Subject to technical changes and errors. - Generated on 23/11/2024

145-9793

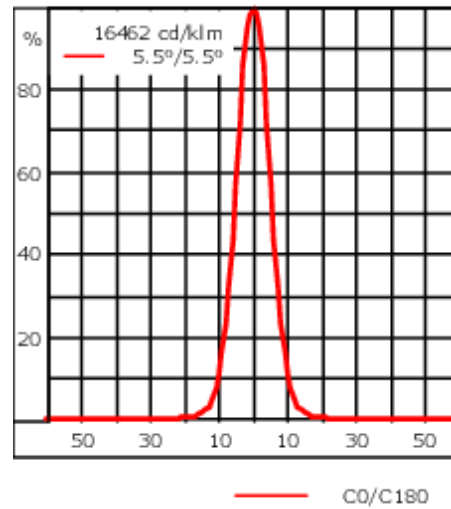
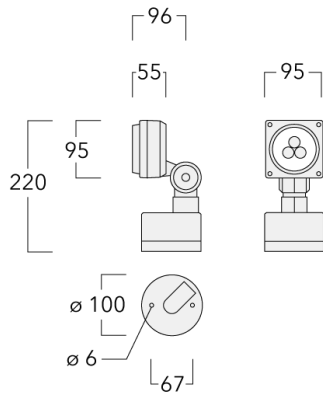

FLD111 LED #3

**we-ef**



## Specifications

### Material description

Body	Marine-grade, die-cast aluminium alloy
Lens	Safety glass lens
Colours	 RAL9004 Signal black  RAL9006 White aluminium  RAL9007 Grey aluminium
Gasket	Silicone CCG® Controlled Compression Gasket
Fasteners	PCS Polymer Coated Stainless Steel Hardware (unpainted)
Ingress protection	IP66
Impact resistance	IK07
Corrosion resistance	5CE+Primer

### Electrical description

Power supply	230V / 50 Hz
Driver / Ballast	Integral EC electronic converter in thermally-separated compartment

### Additional information

Lifetime	Ta=40° L90B10 > 90000h
Warranty	The product is supplied with 10-year warranty. Please refer to the LED Warranty Statement located on <a href="http://www.we-ef.com">www.we-ef.com</a> for further details.

#### WE-EF LIGHTING Pty Ltd

6/13 Downard Street, 3195 Braeside, Victoria - Phone: +61 3 8587 0444 - Fax: +61 3 8587 0499

info.australia@we-ef.com - <https://we-ef.com/aus>

Subject to technical changes and errors. - Generated on 23/11/2024

145-9793

FLD111 LED #3

**we-ef**

## Mounting Accessories

### Ground spike EF

Description	Part ID	H1	Weight (kg)
Ground spike EF1-2/M5 for FLD100	145-9196	270	1.00



**Optical Accessories**

**Optical Adaptor**

Description	Part ID	A	C1
External optical adaptor EA	145-9830	53	91

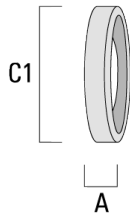

**Glare shield**

Description	Part ID	A	C1
Glare shield ES	145-9831	53	91

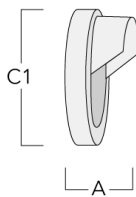

**Snoot**

---

Description	Part ID	A	C1
Snoot ET	145-9832	53	91

---

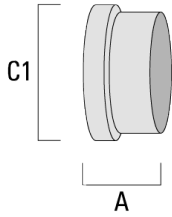

---

**Linear spread lens**

---

Description	Part ID	C1
EO-180-FLD111-LED	145-9833	68

---

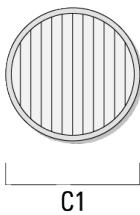

145-9793

FLD111 LED #3

**we-ef**

**Surface wash lens**

---

Description	Part ID	C1
EO-360-FLD111-LED	145-9834	68

---

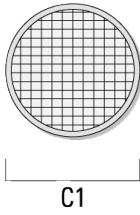

---

**Wallwash lens**

---

Description	Part ID	C1
Wallwash lens IO-20	145-9846	71

---

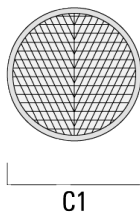

**WE-EF LIGHTING Pty Ltd**

6/13 Downard Street, 3195 Braeside, Victoria - Phone: +61 3 8587 0444 - Fax: +61 3 8587 0499

info.australia@we-ef.com - <https://we-ef.com/aus>

Subject to technical changes and errors. - Generated on 23/11/2024