



Description

IP66. Classe I. Classe II sur demande. IK07. Corps en fonte d'aluminium. Visserie inox avec traitement PCS. Protection contre la corrosion 5CE. Joint silicone. Verre de sécurité. PMMA-LED. Version en 2200K disponible. À préciser lors de la demande de devis.

Poids	2.50 kg
Distribution de la lumière	faisceau symétrique, médium [M]
Source lumineuse	LED-12/24W / 700 mA - 4000 K
IRC	80
Alimentation électrique	ballast électronique
LEDs	12
Rated input power	27 W
Flux lumineux nominal (lm)	
LED Lumen	310
Total Lumen	3720
Tj	85
Rated lumens (lm)	
LED Lumen	267.1
Total Lumen	3205.4
Ta	25

WE-EF Switzerland AG

Himmelrichstrasse 6, 6003 Luzern - Téléphone: +41 22 752 49 94
info.switzerland@we-ef.com - https://we-ef.com/ch_fr

Sous réserve de modifications techniques et d'erreurs. - Généré le 23/11/2024

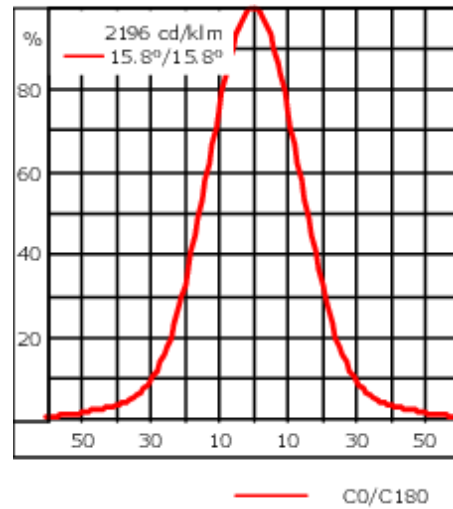
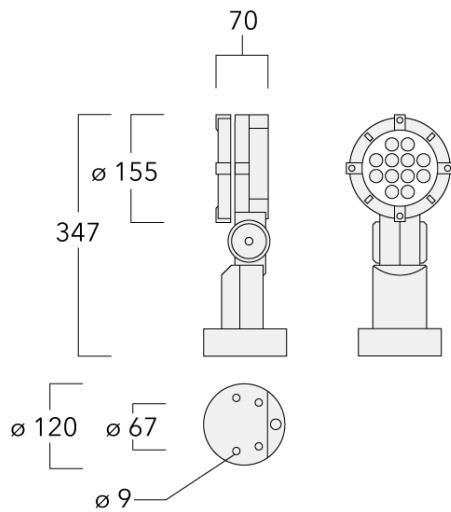

Spécifications

Description du matériel

Corps	Corps en fonte d'aluminium, visserie inox avec traitement PCS
Lentille	Verre de sécurité
Couleurs	<div style="display: flex; align-items: center; margin-bottom: 5px;"> <div style="width: 20px; height: 10px; background-color: black; margin-right: 5px;"></div> RAL9004 Noir de sécurité </div> <div style="display: flex; align-items: center; margin-bottom: 5px;"> <div style="width: 20px; height: 10px; background-color: gray; margin-right: 5px;"></div> RAL9007 Aluminium gris </div> <div style="display: flex; align-items: center; margin-bottom: 5px;"> <div style="width: 20px; height: 10px; background-color: darkgray; margin-right: 5px;"></div> RAL7016 Gris anthracite </div> <div style="display: flex; align-items: center;"> <div style="width: 20px; height: 10px; background-color: lightgray; margin-right: 5px;"></div> RAL9016 Blanc signalisation </div>
Joint	Joint silicone CCG®
Visserie	PCS Inox avec recouvrement polymère
IP	IP66
IK	IK07
Protection contre la corrosion	5CE
Surface exposée au vent	0.041 m ²

146-0400

FLC131 LED

we-ef

Description électrique

Alimentation électrique	220-240V / 50-60 Hz
Driver	Driver électronique séparé thermiquement

Informations complémentaires

Durée de vie	Ta=25° L90B10 > 90000h
Classe d'efficacité énergétique	C-D

WE-EF Switzerland AG

Himmelrichstrasse 6, 6003 Luzern - Téléphone: +41 22 752 49 94

info.switzerland@we-ef.com - https://we-ef.com/ch_fr

Sous réserve de modifications techniques et d'erreurs. - Généré le 23/11/2024

Accessoires Optiques

Visière

Description	Référence	A	C1
Visière ES	146-0156	110	100



Canon anti-éblouissement

Description	Référence	A	C1
Canon anti-éblouissement ET	146-0397	95,5	126



146-0400

FLC131 LED

we-ef

Lentille e'largissante

Description	Référence	C1
IO-360	146-0623	110



Lentille ovalisante

Description	Référence	C1
IO-180-FLC131-LED	146-0418	110

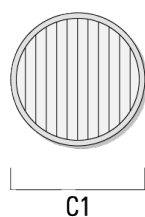

WE-EF Switzerland AG

Himmelrichstrasse 6, 6003 Luzern - Téléphone: +41 22 752 49 94

info.switzerland@we-ef.com - https://we-ef.com/ch_fr

Sous réserve de modifications techniques et d'erreurs. - Généré le 23/11/2024

146-0400

FLC131 LED

we-ef

Lentille rasante

Description	Référence	C1
IO-20-WW-FLC131-LED	146-0645	110

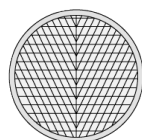

C1

Grille nid d'abeille

Description	Référence	C1
IW-FLC131-LED - [EE][EES]	146-0625	110

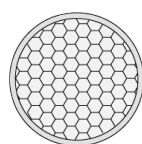

C1

WE-EF Switzerland AG

Himmelrichstrasse 6, 6003 Luzern - Téléphone: +41 22 752 49 94

info.switzerland@we-ef.com - https://we-ef.com/ch_fr

Sous réserve de modifications techniques et d'erreurs. - Généré le 23/11/2024

146-0400

FLC131 LED

we-ef

Accessoires d'installation

Collier pour tubes SP

Description	Référence	D1	Poids (kg)	D
SP1-2/M8 collier simple (Ø 76-89)	146-0246	76-89	1.20	76-89



SP2-2/M8 collier double (Ø 38-60)	146-0247	38-60	1	38-66
-----------------------------------	----------	-------	---	-------



WE-EF Switzerland AG

Himmelrichstrasse 6, 6003 Luzern - Téléphone: +41 22 752 49 94

info.switzerland@we-ef.com - https://we-ef.com/ch_fr

Sous réserve de modifications techniques et d'erreurs. - Généré le 23/11/2024

146-0400

FLC131 LED

we-ef

Description	Référence	D1	Poids (kg)	D
SP2-2/M8 collier double (Ø 76-89)	146-0248	76-89	1.20	76-89



SP1-2/M8 collier simple pour tube (Ø 38-60)	146-0245	38-60	1	38-66
---	----------	-------	---	-------



WE-EF Switzerland AG

Himmelrichstrasse 6, 6003 Luzern - Téléphone: +41 22 752 49 94

info.switzerland@we-ef.com - https://we-ef.com/ch_fr

Sous réserve de modifications techniques et d'erreurs. - Généré le 23/11/2024

Socle de montage EM

Description	Référence	D1	D2	H1	M1	Poids (kg)
EM1-2/M5 socle de montage en fonte d'aluminium	146-0253	160	130	200	9	1.10

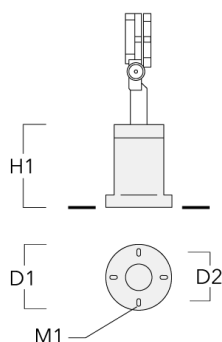
**Piquet à planter EF**

Description	Référence	H1	Poids (kg)
Piquet à planter EF1-2/M5	146-0251	270	0.40



Base à enterrer

Description	Référence	D1	D2	D3	D4	H1	H2	M1	Poids (kg)
Base à enterrer ESV4	300-0461	145	130	102	108	400	350	8	7.85

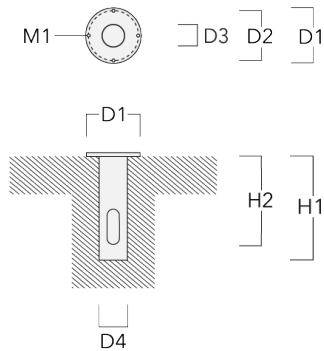
**JB1 Boîte de dérivation étanche**

Description	Référence	D1	D2	M1	Poids (kg)
JB1 Junction box	310-9000	135	67	9	1.6

