

**FLC131 LED RAIL66**



**Description**

IP66. Class I. IK07. Marine-grade, die-cast aluminum alloy. 5CE superior corrosion protection including PCS hardware. Silicone CCG® Controlled Compression Gasket. Safety glass lens. Includes 1 ft of flexible cable enclosed in a stainless conduit, in-line connector and mounting clamp for installation to RAIL66 mounting system. CAD-optimized optics for superior illumination and glare control. Integral driver in thermally separated compartment. OLC® One LED Concept. Factory-installed LED circuit board. 0-10V Dimming comes standard with luminaire.

Specify product with 7 Digit product code - Finish Color. Accessories, such as mounting, optical, and electrical, must be specified separately.

Example: XXX-XXXX-9004 (Black)  
+ XXX-XXXX (Accessory 1)

Weight	6.80 lb
Light distribution	symmetric, medium beam [M]
Light source	LED-12/24W / 700 mA - 3000 K
CRI	80
Power supply	electronic gear
LEDs	12
Rated input power	27 W
<b>Nominal Lumen (lm)</b>	
LED Lumen	290
Total Lumen	3480
Tj	85
<b>Rated lumens (lm)</b>	
LED Lumen	249.9
Total Lumen	2998.6
Ta	25

**WE-EF LIGHTING USA, LLC**

410-D Keystone Drive, 15086 Warrendale, PA 15086 - Phone: +1 724 742 0030  
customersupport.usa@we-ef.com - <https://we-ef.com/us>  
Subject to technical changes and errors. - Generated on 10/23/2024

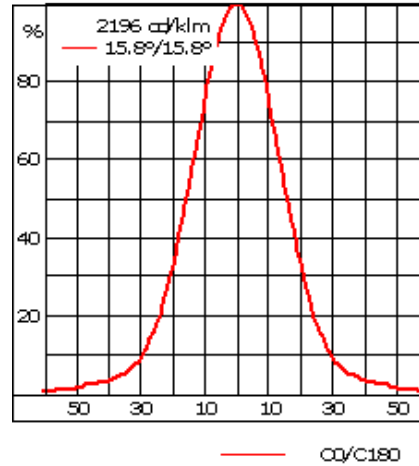
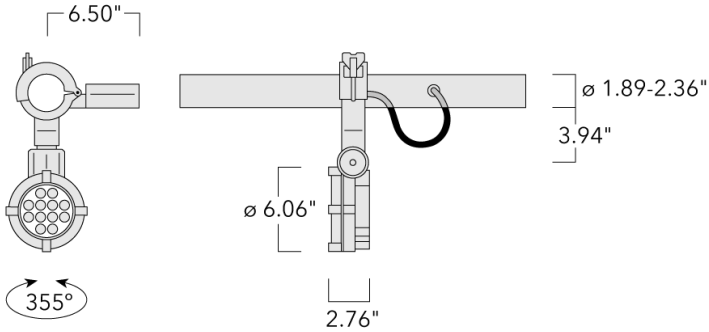

## Specifications

### Material description

Body	Marine-grade die-cast aluminum alloy
Lens	Clear tempered glass lens
Colors	<div style="display: flex; flex-direction: column; gap: 5px;"> <div><span style="display: inline-block; width: 15px; height: 15px; background-color: black; margin-right: 5px;"></span> RAL9004 Black</div> <div><span style="display: inline-block; width: 15px; height: 15px; background-color: grey; margin-right: 5px;"></span> RAL9007 Grey Metallic</div> <div><span style="display: inline-block; width: 15px; height: 15px; background-color: white; margin-right: 5px;"></span> RAL9016 White</div> <div><span style="display: inline-block; width: 15px; height: 15px; background-color: darkgrey; margin-right: 5px;"></span> RAL8019 Dark Bronze</div> </div>
Gasket	Silicone rubber gasket
Fasteners	PCS Polymer Coated Stainless Steel hardware
Ingress protection	IP66
Impact resistance	IK07
Corrosion resistance	5CE

### Electrical description

Power supply	Integral [ECG] electronic driver 120V-277V. 0-10V dimmable, to be specified with order.
Driver / Ballast	Integral EC electronic converter in thermally-separated compartment

**WE-EF LIGHTING USA, LLC**

410-D Keystone Drive, 15086 Warrendale, PA 15086 - Phone: +1 724 742 0030

customersupport.usa@we-ef.com - <https://we-ef.com/us>

Subject to technical changes and errors. - Generated on 10/23/2024

**146-0411**

**we-ef**

**FLC131 LED RAIL66**

**Additional information**

---

Lifetime	Ta=25°/40° L90B10 > 90000h
Listings	ETL listed. Suitable for wet locations.

---

**WE-EF LIGHTING USA, LLC**

410-D Keystone Drive, 15086 Warrendale, PA 15086 - Phone: +1 724 742 0030  
customersupport.usa@we-ef.com - <https://we-ef.com/us>  
Subject to technical changes and errors. - Generated on 10/23/2024

146-0411

**we-ef**

FLC131 LED RAIL66

## Optical Accessories

### Glare shield

---

Description	Part ID	A	C1
Glare shield ES	146-0156	4.33	3.94

---

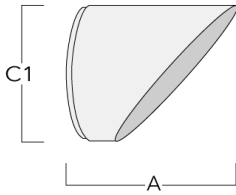

---

### Snoot

**WE-EF LIGHTING USA, LLC**

410-D Keystone Drive, 15086 Warrendale, PA 15086 - Phone: +1 724 742 0030

customersupport.usa@we-ef.com - <https://we-ef.com/us>

Subject to technical changes and errors. - Generated on 10/23/2024

**FLC131 LED RAIL66**

---

Description	Part ID	A	C1
Snoot ET	146-0397	3.76	4.96

---

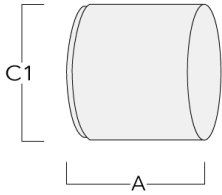

---

**Softening Lens**

---

Description	Part ID	C1
IO-360	146-0623	4.33"

---

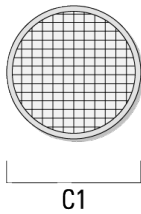

---

**Linear spread lens**

**WE-EF LIGHTING USA, LLC**

410-D Keystone Drive, 15086 Warrendale, PA 15086 - Phone: +1 724 742 0030

customersupport.usa@we-ef.com - <https://we-ef.com/us>

Subject to technical changes and errors. - Generated on 10/23/2024

**FLC131 LED RAIL66**

---

Description	Part ID	C1
IO-180-FLC131-LED	146-0418	4.30

---

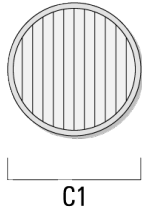

---

**Wallwash lens**

---

Description	Part ID	C1
IO-20-WW-FLC131-LED	146-0645	4.33

---

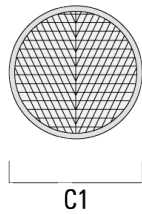

---

**Honeycomb louvre**

**WE-EF LIGHTING USA, LLC**

410-D Keystone Drive, 15086 Warrendale, PA 15086 - Phone: +1 724 742 0030

customersupport.usa@we-ef.com - <https://we-ef.com/us>

Subject to technical changes and errors. - Generated on 10/23/2024

**FLC131 LED RAIL66**

---

Description	Part ID	C1
IW-FLC131-LED	146-0625	4.33

---

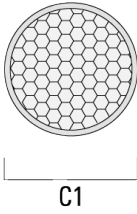

**Mounting Accessories**

**Universal**

Description	Part ID	C1	C2	H1	M1	Weight (lb)	L1	L2
2 Mains outlets (L=45.28)	310-9200	3.00	1.20	7.90	0.5	13.00	45.28	41.14

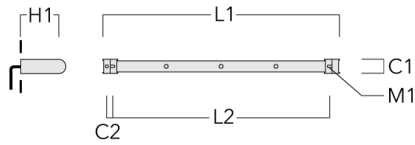

3 Mains outlets (L=45.28)	310-9202	3.00	1.20	7.90	0.5	13.00	45.28	41.14
---------------------------	----------	------	------	------	-----	-------	-------	-------

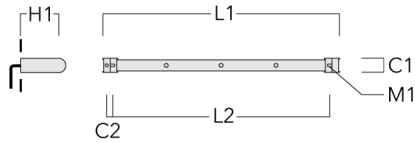



**FLC131 LED RAIL66**

Description	Part ID	C1	C2	H1	M1	Weight (lb)	L1	L2
3 Mains outlets (L=64.69)	310-9210	3.00	1.18	7.90	0.5	15.90	64.69	60.83

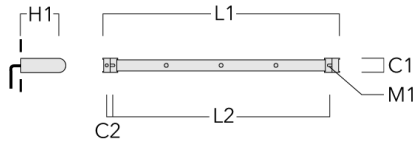

4 Mains outlets (L=64.69)	310-9212	3.00	1.18	7.90	5	13.00 lbs	64.69	60.83
---------------------------	----------	------	------	------	---	-----------	-------	-------

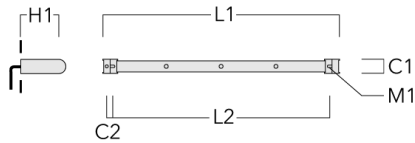

**WE-EF LIGHTING USA, LLC**

410-D Keystone Drive, 15086 Warrendale, PA 15086 - Phone: +1 724 742 0030

customersupport.usa@we-ef.com - <https://we-ef.com/us>

Subject to technical changes and errors. - Generated on 10/23/2024

**FLC131 LED RAIL66**

Description	Part ID	C1	C2	H1	M1	Weight (lb)	L1	L2
4 Mains outlets (L=84.65)	310-9220	3.00	1.18	7.90	0.5	18.76	84.65	80.51

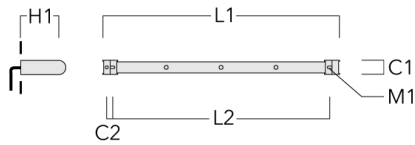

6 Mains outlets (L=84.65)	310-9222	3.00	1.18	7.90	0.5	18.76	84.65	80.51
---------------------------	----------	------	------	------	-----	-------	-------	-------

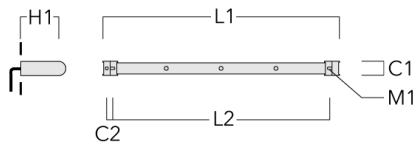

**Flat Surface Fitters**

**WE-EF LIGHTING USA, LLC**

410-D Keystone Drive, 15086 Warrendale, PA 15086 - Phone: +1 724 742 0030

customersupport.usa@we-ef.com - <https://we-ef.com/us>

Subject to technical changes and errors. - Generated on 10/23/2024

**FLC131 LED RAIL66**

Description	Part ID	C1	C2	D1	D2	L	M1	Weight (lb)
Surface fitters (pair)	310-9290	0.79	1.18	7.1	5.5	42.1	.35	3.70

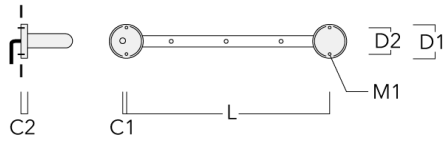

**Column Fitters**

Description	Part ID	C1	C2	L	M1	Weight (lb)
Column Fitters (pair)	310-9294	1.20	4.00	43.9	.5	2.00

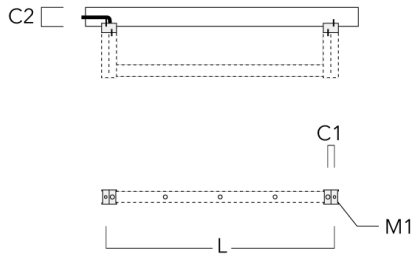

**Cantilever**

**WE-EF LIGHTING USA, LLC**

410-D Keystone Drive, 15086 Warrendale, PA 15086 - Phone: +1 724 742 0030

customersupport.usa@we-ef.com - <https://we-ef.com/us>

Subject to technical changes and errors. - Generated on 10/23/2024

**FLC131 LED RAIL66**

Description	Part ID	C1	C2	C3	H1	M1	Weight (lb)	L1	L2
2 Mains outlets (L=45.28)	310-9230	8.66	4.72	2.36	23.62	0.51	26.46	45.28	42.13

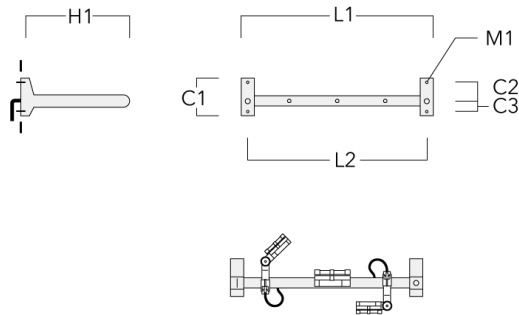

3 Mains outlets (L=45.28)	310-9232	8.66	4.72	2.36	23.62	0.51	26.46	45.28	42.13
---------------------------	----------	------	------	------	-------	------	-------	-------	-------

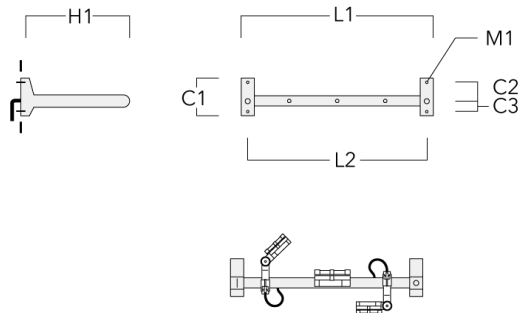

**WE-EF LIGHTING USA, LLC**

410-D Keystone Drive, 15086 Warrendale, PA 15086 - Phone: +1 724 742 0030

customersupport.usa@we-ef.com - <https://we-ef.com/us>

Subject to technical changes and errors. - Generated on 10/23/2024

**FLC131 LED RAIL66**

Description	Part ID	C1	C2	C3	H1	M1	Weight (lb)	L1	L2
3 Mains outlets (L=64.69)	310-9240	8.66	4.72	2.36	23.62	0.51	29.32	64.96	61.81

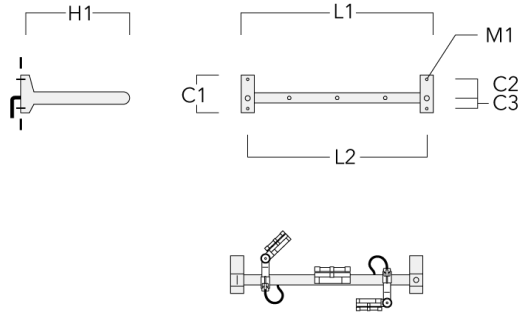

4 Mains outlets (L=64.69)	310-9242	8.66	4.72	2.36	23.62	0.51	29.32	64.96	61.81
---------------------------	----------	------	------	------	-------	------	-------	-------	-------

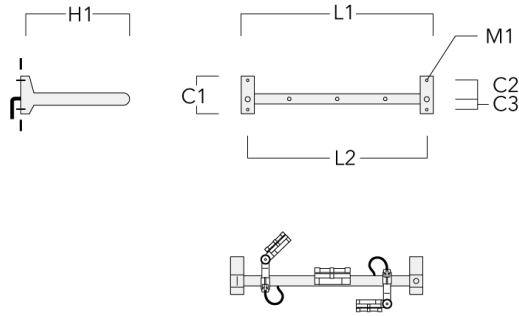

**WE-EF LIGHTING USA, LLC**

410-D Keystone Drive, 15086 Warrendale, PA 15086 - Phone: +1 724 742 0030

customersupport.usa@we-ef.com - <https://we-ef.com/us>

Subject to technical changes and errors. - Generated on 10/23/2024

**FLC131 LED RAIL66**

Description	Part ID	C1	C2	C3	H1	M1	Weight (lb)	L1	L2
4 Mains outlets (L=84.65)	310-9250	8.66	4.72	2.36	23.62	0.51	32.19	84.65	81.49

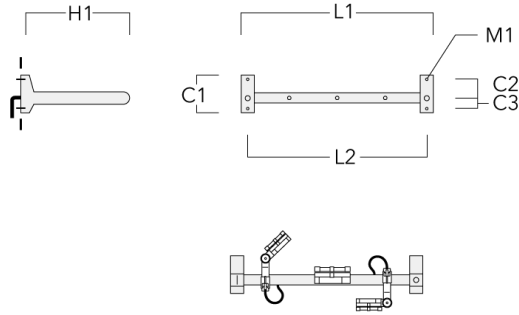

6 Mains outlets (L=84.65)	310-9252	8.66	4.72	2.36	23.62	0.51	32.19	84.65	81.5
---------------------------	----------	------	------	------	-------	------	-------	-------	------

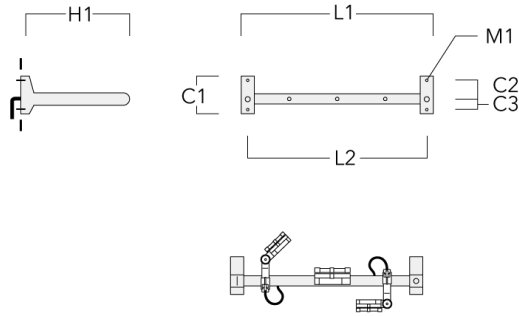

**WE-EF LIGHTING USA, LLC**

410-D Keystone Drive, 15086 Warrendale, PA 15086 - Phone: +1 724 742 0030

customersupport.usa@we-ef.com - <https://we-ef.com/us>

Subject to technical changes and errors. - Generated on 10/23/2024

**146-0411**

**FLC131 LED RAIL66**

**WE-EF LIGHTING USA, LLC**

410-D Keystone Drive, 15086 Warrendale, PA 15086

Phone: +1 724 742 0030

[customersupport.usa@we-ef.com](mailto:customersupport.usa@we-ef.com)

<https://we-ef.com/us>

Subject to technical changes and errors.

Generated on 10/23/2024

**we-ef**

---

A Fagerhult Group Company