



Description

IP66, Class I. IK07. Marine-grade, die-cast aluminium alloy. 5CE superior corrosion protection + primer including PCS hardware. Safety glass lens. Silicone CCG® Controlled Compression Gasket. Luminaire is factory-sealed and does not need to be opened during installation. Integral EC electronic converter in thermally-separated compartment. Advanced thermal management protects LEDs while optimising lumens output. CAD-optimised optics for superior illumination and glare control. OLC® One LED Concept.

Including 0.4 m of flexible cable enclosed in a stainless conduit, in-line connector and mounting clamp for installation to RAIL66 mounting system.

If ordering a fitting to be installed on an existing rail, please confirm the rail version with your local distributor or our customer excellence team as connectors vary.

| | |
|--------------------|--|
| Weight | 3.10 kg |
| Light distribution | symmetric, very narrow beam, sharp cut-off [EES] |
| Light source | LED-12/24W / 700 mA - 3000 K |
| CRI | 80 |
| Power supply | EC |
| LEDs | 12 |
| Rated input power | 27 W |

Nominal Lumen (lm)

| | |
|----------------|------|
| LED Lumen | 290 |
| Total Lumen | 3480 |
| T _j | 85 |

Rated lumens (lm)

| | |
|----------------|--------|
| LED Lumen | 256.5 |
| Total Lumen | 3077.9 |
| T _a | 25 |

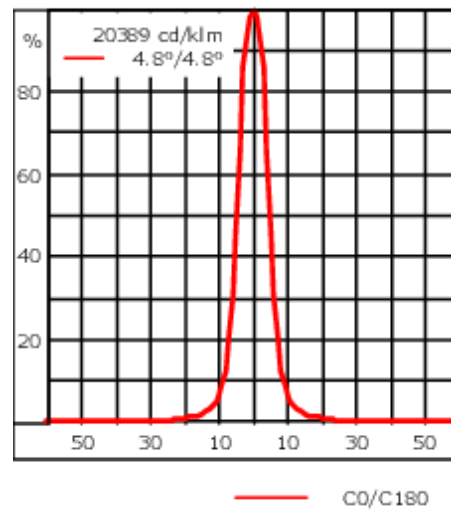

Specifications

Material description

| | |
|----------------------|--|
| Body | Marine-grade die-cast aluminium alloy |
| Lens | Safety glass lens |
| Colours | <div style="display: flex; align-items: center;"> <div style="width: 20px; height: 15px; background-color: black; margin-right: 5px;"></div> <div style="margin-right: 10px;">RAL9004 Signal black</div> </div> <div style="display: flex; align-items: center;"> <div style="width: 20px; height: 15px; background-color: #cccccc; margin-right: 5px;"></div> <div style="margin-right: 10px;">RAL9006 White aluminium</div> </div> <div style="display: flex; align-items: center;"> <div style="width: 20px; height: 15px; background-color: #808080; margin-right: 5px;"></div> <div style="margin-right: 10px;">RAL9007 Grey aluminium</div> </div> |
| Gasket | Silicone CCG® Controlled Compression Gasket |
| Fasteners | PCS Polymer Coated Stainless Steel Hardware (unpainted) |
| Ingress protection | IP66 |
| Impact resistance | IK07 |
| Corrosion resistance | 5CE+Primer |

Electrical description

| | |
|------------------|---|
| Power supply | 230V / 50 Hz |
| Driver / Ballast | Integral EC electronic converter in thermally-separated compartment |

Additional information

| | |
|----------|--|
| Lifetime | Ta=40° L90B10 > 90000h |
| Warranty | The product is supplied with 10-year warranty. Please refer to the LED Warranty Statement located on www.we-ef.com for further details. |

Optical Accessories

Glare shield

| Description | Part ID | A | C1 |
|-----------------|----------|-----|-----|
| Glare shield ES | 146-0156 | 110 | 100 |



Snoot

| Description | Part ID | A | C1 |
|-------------|----------|------|-----|
| Snoot ET | 146-0397 | 95,5 | 126 |



FLC131 LED RAIL66

Surface wash lens

| Description | Part ID | C1 |
|-------------|----------|-----|
| IO-360 | 146-0419 | 110 |



Linear louvre

| Description | Part ID | C1 |
|------------------|----------|-----|
| Linear louvre IL | 146-9055 | 110 |



146-0414

FLC131 LED RAIL66

we-ef

Linear spread lens

| Description | Part ID | C1 |
|-------------------|----------|-----|
| IO-180-FLC131-LED | 146-0418 | 110 |

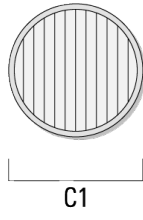

Wallwash lens

| Description | Part ID | C1 |
|---------------------|----------|-----|
| IO-20-WW-FLC131-LED | 146-0645 | 110 |

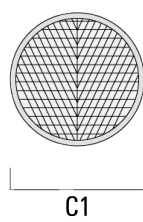

WE-EF LIGHTING Pty Ltd

6/13 Downard Street, 3195 Braeside, Victoria - Phone: +61 3 8587 0444 - Fax: +61 3 8587 0499

info.australia@we-ef.com - <https://we-ef.com/aus>

Subject to technical changes and errors. - Generated on 23/11/2024

146-0414

FLC131 LED RAIL66

we-ef

Honeycomb louvre

| Description | Part ID | C1 |
|---------------|----------|-----|
| IW-FLC131-LED | 146-0625 | 110 |



WE-EF LIGHTING Pty Ltd

6/13 Downard Street, 3195 Braeside, Victoria - Phone: +61 3 8587 0444 - Fax: +61 3 8587 0499

info.australia@we-ef.com - <https://we-ef.com/aus>

Subject to technical changes and errors. - Generated on 23/11/2024

Mounting Accessories

Universal

| Description | Part ID | C1 | C2 | H1 | M1 | Weight (kg) | L1 | L2 |
|--------------------------|----------|----|----|-----|----|-------------|------|------|
| 2 Mains outlets (L=1150) | 310-9200 | 75 | 30 | 200 | 12 | 5.90 | 1150 | 1045 |

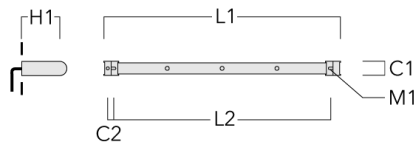

| | | | | | | | | |
|--------------------------|----------|----|----|-----|----|------|------|------|
| 3 Mains outlets (L=1150) | 310-9202 | 75 | 30 | 200 | 12 | 5.90 | 1150 | 1045 |
|--------------------------|----------|----|----|-----|----|------|------|------|

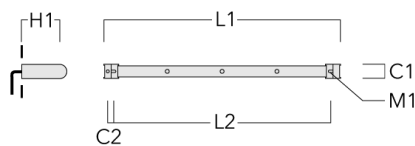

FLC131 LED RAIL66

| Description | Part ID | C1 | C2 | H1 | M1 | Weight (kg) | L1 | L2 |
|--------------------------|----------|----|----|-----|----|-------------|------|------|
| 3 Mains outlets (L=1650) | 310-9210 | 75 | 30 | 200 | 12 | 7.20 | 1650 | 1545 |



| | | | | | | | | |
|--------------------------|----------|----|----|-----|----|------|------|------|
| 4 Mains outlets (L=1650) | 310-9212 | 75 | 30 | 200 | 12 | 7.20 | 1650 | 1545 |
|--------------------------|----------|----|----|-----|----|------|------|------|



FLC131 LED RAIL66

| Description | Part ID | C1 | C2 | H1 | M1 | Weight (kg) | L1 | L2 |
|--------------------------|----------|----|----|-----|----|-------------|------|------|
| 4 Mains outlets (L=2150) | 310-9220 | 75 | 30 | 200 | 12 | 8.50 | 2150 | 2045 |

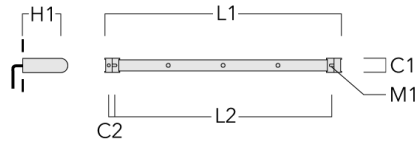

| | | | | | | | | |
|--------------------------|----------|----|----|-----|----|------|------|------|
| 6 Mains outlets (L=2150) | 310-9222 | 75 | 30 | 200 | 12 | 8.50 | 2150 | 2045 |
|--------------------------|----------|----|----|-----|----|------|------|------|

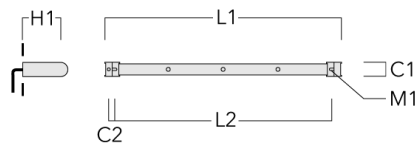

FLC131 LED RAIL66

Flat Surface Fitters

| Description | Part ID | C1 | C2 | D1 | D2 | L | M1 | Weight (kg) |
|------------------------|----------|----|----|-----|-----|------|----|-------------|
| Surface fitters (pair) | 310-9290 | 20 | 30 | 180 | 140 | 1070 | 9 | 1.70 |

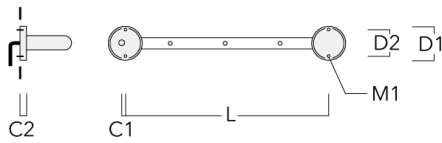

Column Fitters

| Description | Part ID | C1 | C2 | L | M1 | Weight (kg) |
|-----------------------|----------|----|-----|------|----|-------------|
| Column fitters (pair) | 310-9294 | 30 | 100 | 1115 | 12 | 0.90 |

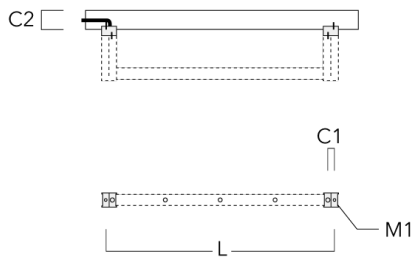

FLC131 LED RAIL66

Cantilever

| Description | Part ID | C1 | C2 | C3 | H1 | M1 | Weight (kg) | L1 | L2 |
|--------------------------|----------|-----|-----|----|-----|----|-------------|------|------|
| 2 Mains outlets (L=1150) | 310-9230 | 220 | 120 | 60 | 600 | 13 | 12 | 1150 | 1070 |



| | | | | | | | | | |
|--------------------------|----------|-----|-----|----|-----|----|----|------|------|
| 3 Mains outlets (L=1150) | 310-9232 | 220 | 120 | 60 | 600 | 13 | 12 | 1150 | 1070 |
|--------------------------|----------|-----|-----|----|-----|----|----|------|------|



FLC131 LED RAIL66

| Description | Part ID | C1 | C2 | C3 | H1 | M1 | Weight (kg) | L1 | L2 |
|--------------------------|----------|-----|-----|----|-----|----|-------------|------|------|
| 3 Mains outlets (L=1650) | 310-9240 | 220 | 120 | 60 | 600 | 13 | 13.30 | 1650 | 1570 |

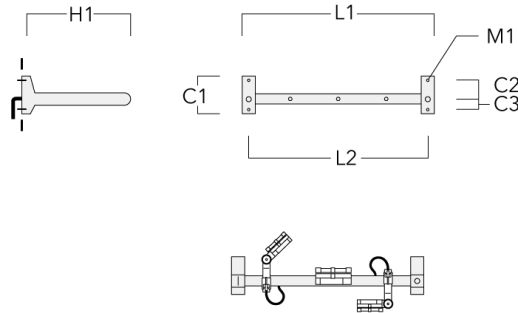

| | | | | | | | | | |
|--------------------------|----------|-----|-----|----|-----|----|-------|------|------|
| 4 Mains outlets (L=1650) | 310-9242 | 220 | 120 | 60 | 600 | 13 | 13.30 | 1650 | 1570 |
|--------------------------|----------|-----|-----|----|-----|----|-------|------|------|

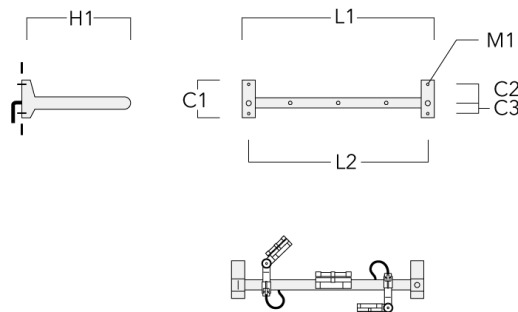

FLC131 LED RAIL66

| Description | Part ID | C1 | C2 | C3 | H1 | M1 | Weight (kg) | L1 | L2 |
|--------------------------|----------|-----|-----|----|-----|----|-------------|------|------|
| 4 Mains outlets (L=2150) | 310-9250 | 220 | 120 | 60 | 600 | 13 | 14.60 | 2150 | 2070 |

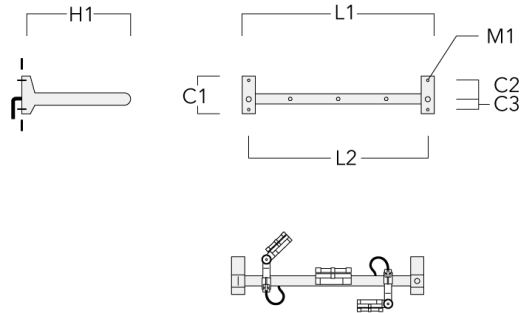

| | | | | | | | | | |
|--------------------------|----------|-----|-----|----|-----|----|-------|------|------|
| 6 Mains outlets (L=2150) | 310-9252 | 220 | 120 | 60 | 600 | 13 | 14.60 | 2150 | 2070 |
|--------------------------|----------|-----|-----|----|-----|----|-------|------|------|

