



Description

IP66, Class I. IK07. Marine-grade, die-cast aluminium alloy. 5CE superior corrosion protection + primer including PCS hardware. Safety glass lens. Silicone CCG® Controlled Compression Gasket. Luminaire is factory-sealed and does not need to be opened during installation. Integral EC electronic converter in thermally-separated compartment. Advanced thermal management protects LEDs while optimising lumens output. CAD-optimised optics for superior illumination and glare control. OLC® One LED Concept.

Including 0.4 m of flexible cable enclosed in a stainless conduit, in-line connector and mounting clamp for installation to RAIL66 mounting system.

If ordering a fitting to be installed on an existing rail, please confirm the rail version with your local distributor or our customer excellence team as connectors vary.

Weight	3.10 kg
Light distribution	linear spread, very narrow beam, sharp cut-off [EES]
Light source	LED-12/24W / 700 mA - 4000 K
CRI	80
Power supply	EC
LEDs	12
Rated input power	27 W
Nominal Lumen (lm)	
LED Lumen	310
Total Lumen	3720
T _j	85
Rated lumens (lm)	
LED Lumen	255.3
Total Lumen	3063.5
T _a	25

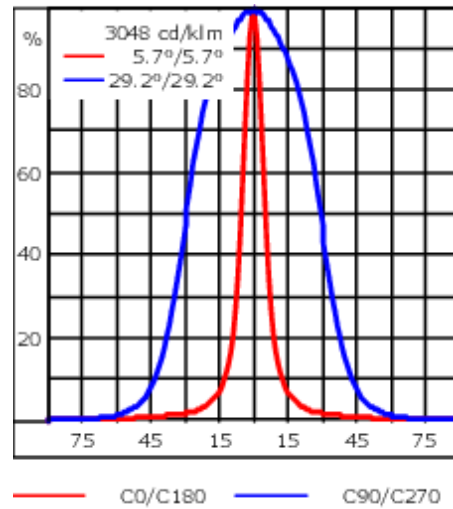
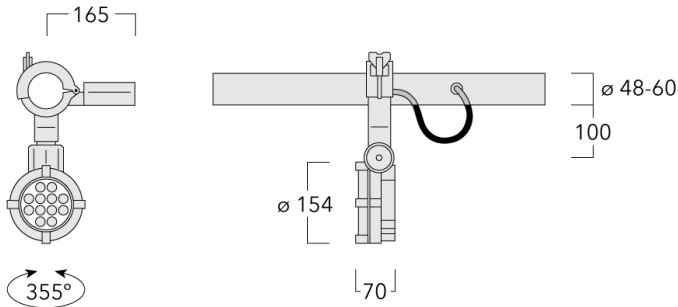

Specifications

Material description

Body	Marine-grade die-cast aluminium alloy
Lens	Safety glass lens
Colours	<div style="display: flex; align-items: center;"> <div style="width: 20px; height: 15px; background-color: black; margin-right: 5px;"></div> RAL9004 Signal black </div> <div style="display: flex; align-items: center; margin-top: 5px;"> <div style="width: 20px; height: 15px; background-color: #cccccc; margin-right: 5px;"></div> RAL9006 White aluminium </div> <div style="display: flex; align-items: center; margin-top: 5px;"> <div style="width: 20px; height: 15px; background-color: #808080; margin-right: 5px;"></div> RAL9007 Grey aluminium </div>
Gasket	Silicone CCG® Controlled Compression Gasket
Fasteners	PCS Polymer Coated Stainless Steel Hardware (unpainted)
Ingress protection	IP66
Impact resistance	IK07
Corrosion resistance	5CE+Primer

Electrical description

Power supply	230V / 50 Hz
Driver / Ballast	Integral EC electronic converter in thermally-separated compartment

Additional information

Lifetime	Ta=40° L90B10 > 90000h
Warranty	The product is supplied with 10-year warranty. Please refer to the LED Warranty Statement located on www.we-ef.com for further details.

Optical Accessories

Glare shield

Description	Part ID	A	C1
Glare shield ES	146-0156	110	100



Snoot

Description	Part ID	A	C1
Snoot ET	146-0397	95,5	126



FLC131 LED RAIL66

Surface wash lens

Description	Part ID	C1
IO-360	146-0419	110



Linear louvre

Description	Part ID	C1
Linear louvre IL	146-9055	110



FLC131 LED RAIL66

Linear spread lens

Description	Part ID	C1
IO-180-FLC131-LED	146-0418	110

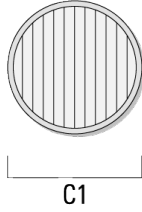

Wallwash lens

Description	Part ID	C1
IO-20-WW-FLC131-LED	146-0645	110

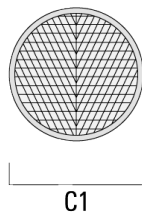

146-0415+146-0418

we-ef

FLC131 LED RAIL66

Honeycomb louvre

Description	Part ID	C1
IW-FLC131-LED	146-0625	110

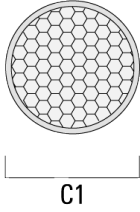

WE-EF LIGHTING Pty Ltd

6/13 Downard Street, 3195 Braeside, Victoria - Phone: +61 3 8587 0444 - Fax: +61 3 8587 0499

info.australia@we-ef.com - <https://we-ef.com/aus>

Subject to technical changes and errors. - Generated on 23/11/2024

Mounting Accessories

Universal

Description	Part ID	C1	C2	H1	M1	Weight (kg)	L1	L2
2 Mains outlets (L=1150)	310-9200	75	30	200	12	5.90	1150	1045

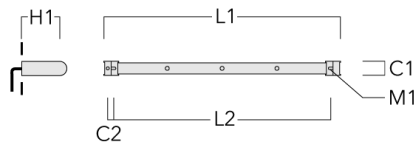

3 Mains outlets (L=1150)	310-9202	75	30	200	12	5.90	1150	1045
--------------------------	----------	----	----	-----	----	------	------	------

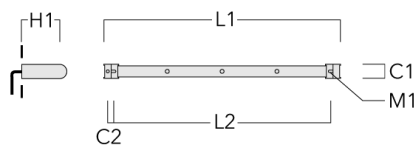

FLC131 LED RAIL66

Description	Part ID	C1	C2	H1	M1	Weight (kg)	L1	L2
3 Mains outlets (L=1650)	310-9210	75	30	200	12	7.20	1650	1545



4 Mains outlets (L=1650)	310-9212	75	30	200	12	7.20	1650	1545
--------------------------	----------	----	----	-----	----	------	------	------



FLC131 LED RAIL66

Description	Part ID	C1	C2	H1	M1	Weight (kg)	L1	L2
4 Mains outlets (L=2150)	310-9220	75	30	200	12	8.50	2150	2045

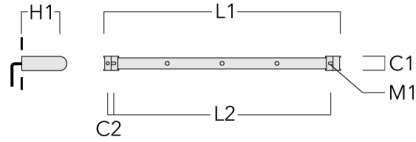

6 Mains outlets (L=2150)	310-9222	75	30	200	12	8.50	2150	2045
--------------------------	----------	----	----	-----	----	------	------	------

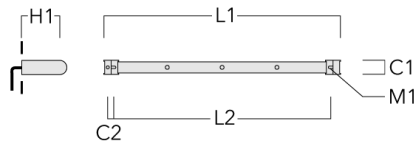

FLC131 LED RAIL66

Flat Surface Fitters

Description	Part ID	C1	C2	D1	D2	L	M1	Weight (kg)
Surface fitters (pair)	310-9290	20	30	180	140	1070	9	1.70

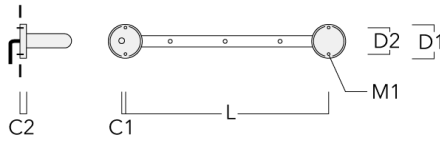

Column Fitters

Description	Part ID	C1	C2	L	M1	Weight (kg)
Column fitters (pair)	310-9294	30	100	1115	12	0.90

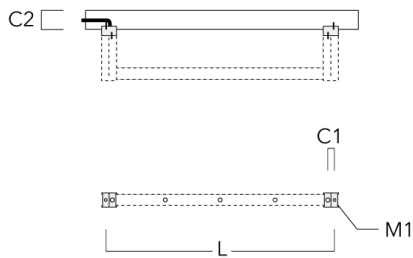

FLC131 LED RAIL66

Cantilever

Description	Part ID	C1	C2	C3	H1	M1	Weight (kg)	L1	L2
2 Mains outlets (L=1150)	310-9230	220	120	60	600	13	12	1150	1070

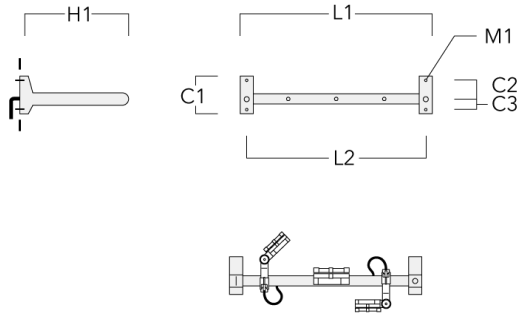

3 Mains outlets (L=1150)	310-9232	220	120	60	600	13	12	1150	1070
--------------------------	----------	-----	-----	----	-----	----	----	------	------

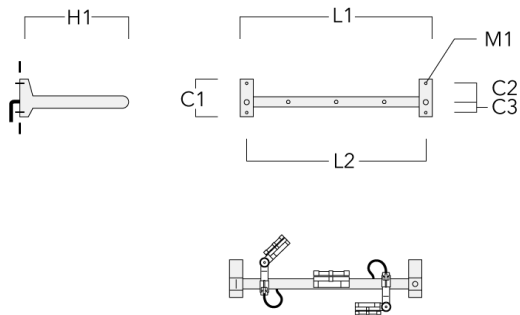

FLC131 LED RAIL66

Description	Part ID	C1	C2	C3	H1	M1	Weight (kg)	L1	L2
3 Mains outlets (L=1650)	310-9240	220	120	60	600	13	13.30	1650	1570

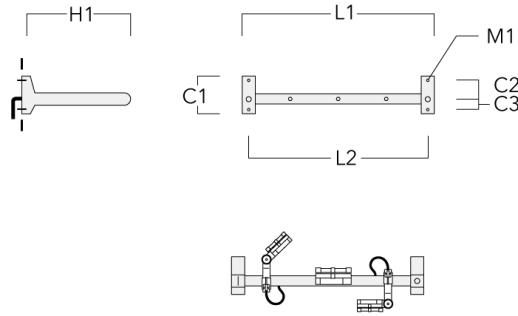

4 Mains outlets (L=1650)	310-9242	220	120	60	600	13	13.30	1650	1570
--------------------------	----------	-----	-----	----	-----	----	-------	------	------

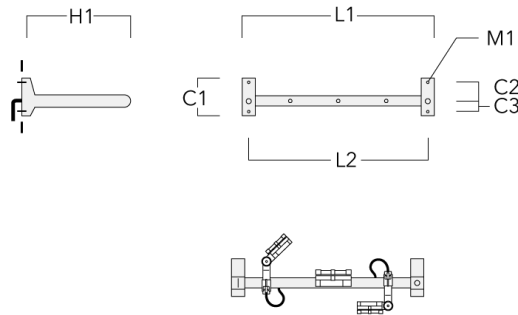

FLC131 LED RAIL66

Description	Part ID	C1	C2	C3	H1	M1	Weight (kg)	L1	L2
4 Mains outlets (L=2150)	310-9250	220	120	60	600	13	14.60	2150	2070

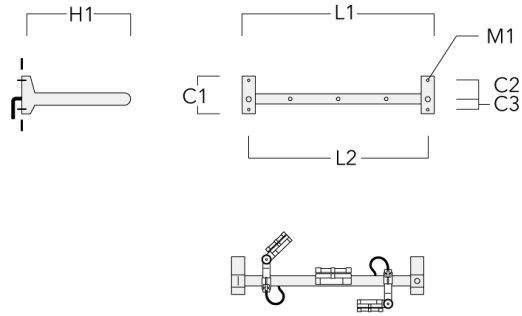

6 Mains outlets (L=2150)	310-9252	220	120	60	600	13	14.60	2150	2070
--------------------------	----------	-----	-----	----	-----	----	-------	------	------

