

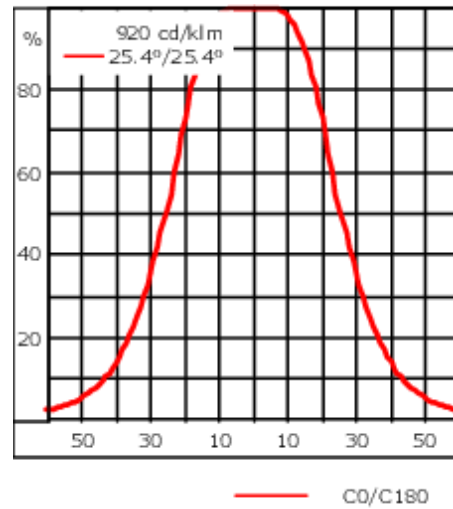

Description

IP66. Classe I. Classe II sur demande. IK07. Corps en fonte d'aluminium. Visserie inox avec traitement PCS. Protection contre la corrosion 5CE. Joint silicone. Verre de sécurité. PMMA-LED. Version en 2200K disponible. À préciser lors de la demande de devis.

Poids	2.50 kg
Distribution de la lumière	faisceau symétrique, extensif [B]
Source lumineuse	LED-12/24W / 700 mA - 4000 K
IRC	80
Alimentation électrique	ballast électronique
LEDs	12
Rated input power	27 W
Flux lumineux nominal (lm)	
LED Lumen	310
Total Lumen	3720
Tj	85
Rated lumens (lm)	
LED Lumen	241.3
Total Lumen	2896
Ta	25

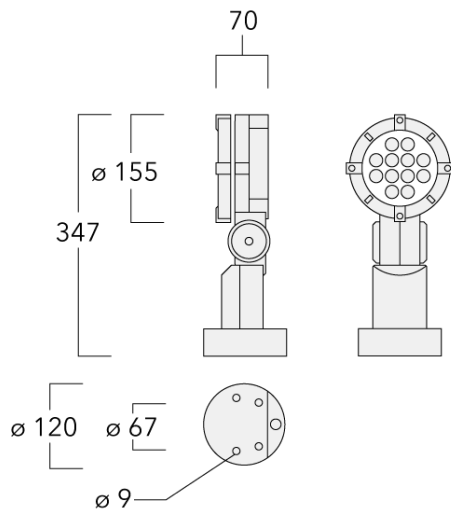

Spécifications

Description du matériel

Corps	Corps en fonte d'aluminium, visserie inox avec traitement PCS
Lentille	Verre de sécurité
Couleurs	<div style="display: flex; align-items: center;"> <div style="width: 20px; height: 10px; background-color: black; margin-right: 5px;"></div> RAL9004 Noir de sécurité </div> <div style="display: flex; align-items: center; margin-top: 5px;"> <div style="width: 20px; height: 10px; background-color: gray; margin-right: 5px;"></div> RAL9007 Aluminium gris </div> <div style="display: flex; align-items: center; margin-top: 5px;"> <div style="width: 20px; height: 10px; background-color: darkgray; margin-right: 5px;"></div> RAL7016 Gris anthracite </div> <div style="display: flex; align-items: center; margin-top: 5px;"> <div style="width: 20px; height: 10px; background-color: lightgray; margin-right: 5px;"></div> RAL9016 Blanc signalisation </div>
Joint	Joint silicone CCG®
Visserie	PCS Inox avec recouvrement polymère
IP	IP66
IK	IK07
Protection contre la corrosion	5CE
Surface exposée au vent	0.041 m ²

146-0495

FLC131 LED

we-ef

Description électrique

Alimentation électrique	220-240V / 50-60 Hz
Driver	Driver électronique séparé thermiquement

Informations complémentaires

Durée de vie	Ta=25° L90B10 > 90000h
Classe d'efficacité énergétique	C-D

WE-EF Switzerland AG

Himmelrichstrasse 6, 6003 Luzern - Téléphone: +41 22 752 49 94

info.switzerland@we-ef.com - https://we-ef.com/ch_fr

Sous réserve de modifications techniques et d'erreurs. - Généré le 23/11/2024

Accessoires Optiques

Visière

Description	Référence	A	C1
Visière ES	146-0156	110	100



Canon anti-éblouissement

Description	Référence	A	C1
Canon anti-éblouissement ET	146-0397	95,5	126



Lentille e'largissante

Description	Référence	C1
IO-360	146-0623	110

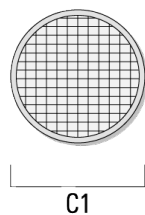
**Lentille ovalisante**

Description	Référence	C1
IO-180-FLC131-LED	146-0418	110

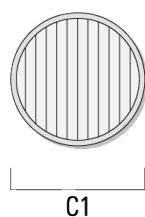

146-0495

FLC131 LED

we-ef

Lentille rasante

Description	Référence	C1
IO-20-WW-FLC131-LED	146-0645	110

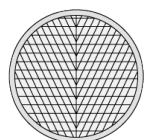

C1

Grille nid d'abeille

Description	Référence	C1
IW-FLC131-LED - [EE][EES]	146-0625	110

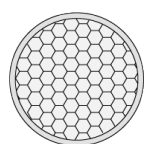

C1

WE-EF Switzerland AG

Himmelrichstrasse 6, 6003 Luzern - Téléphone: +41 22 752 49 94

info.switzerland@we-ef.com - https://we-ef.com/ch_fr

Sous réserve de modifications techniques et d'erreurs. - Généré le 23/11/2024

146-0495

FLC131 LED

we-ef

Accessoires d'installation

Collier pour tubes SP

Description	Référence	D1	Poids (kg)	D
SP1-2/M8 collier simple (Ø 76-89)	146-0246	76-89	1.20	76-89



SP2-2/M8 collier double (Ø 38-60)	146-0247	38-60	1	38-66
-----------------------------------	----------	-------	---	-------



WE-EF Switzerland AG

Himmelrichstrasse 6, 6003 Luzern - Téléphone: +41 22 752 49 94

info.switzerland@we-ef.com - https://we-ef.com/ch_fr

Sous réserve de modifications techniques et d'erreurs. - Généré le 23/11/2024

146-0495

FLC131 LED

we-ef

Description	Référence	D1	Poids (kg)	D
SP2-2/M8 collier double (Ø 76-89)	146-0248	76-89	1.20	76-89



SP1-2/M8 collier simple pour tube (Ø 38-60)	146-0245	38-60	1	38-66
---	----------	-------	---	-------



WE-EF Switzerland AG

Himmelrichstrasse 6, 6003 Luzern - Téléphone: +41 22 752 49 94

info.switzerland@we-ef.com - https://we-ef.com/ch_fr

Sous réserve de modifications techniques et d'erreurs. - Généré le 23/11/2024

Socle de montage EM

Description	Référence	D1	D2	H1	M1	Poids (kg)
EM1-2/M5 socle de montage en fonte d'aluminium	146-0253	160	130	200	9	1.10

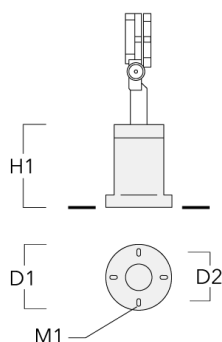
**Piquet à planter EF**

Description	Référence	H1	Poids (kg)
Piquet à planter EF1-2/M5	146-0251	270	0.40

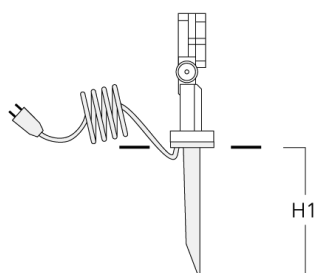

Base à enterrer

Description	Référence	D1	D2	D3	D4	H1	H2	M1	Poids (kg)
Base à enterrer ESV4	300-0461	145	130	102	108	400	350	8	7.85

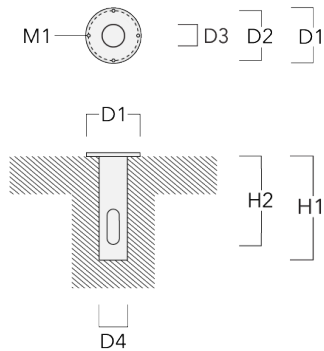
**JB1 Boîte de dérivation étanche**

Description	Référence	D1	D2	M1	Poids (kg)
JB1 Junction box	310-9000	135	67	9	1.6

