



### Description

IP66, Class I. IK07. Marine-grade, die-cast aluminium alloy. 5CE superior corrosion protection including PCS hardware. Safety glass lens. Silicone CCG® Controlled Compression Gasket. Luminaire is factory-sealed and does not need to be opened during installation.

Integral EC electronic converter in thermally-separated compartment. Advanced thermal management protects LEDs while optimising lumens output. CAD-optimised optics for superior illumination and glare control. OLC® One LED Concept.

Including 0.4 m of flexible cable enclosed in a stainless conduit, in-line connector and mounting clamp for installation to RAIL66 mounting system.

|                           |                                  |
|---------------------------|----------------------------------|
| Weight                    | 3.10 kg                          |
| Light distribution        | symmetric, very narrow beam [EE] |
| Light source              | LED-12/24W / 700 mA - 4000 K     |
| CRI                       | 80                               |
| Power supply              | EC                               |
| LEDs                      | 12                               |
| Rated input power         | 27 W                             |
| <b>Nominal Lumen (lm)</b> |                                  |
| LED Lumen                 | 310                              |
| Total Lumen               | 3720                             |
| T <sub>j</sub>            | 85                               |
| <b>Rated lumens (lm)</b>  |                                  |
| LED Lumen                 | 256.9                            |
| Total Lumen               | 3082.5                           |
| T <sub>a</sub>            | 25                               |

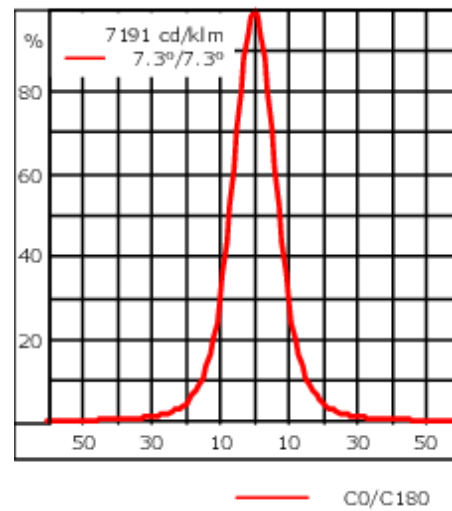
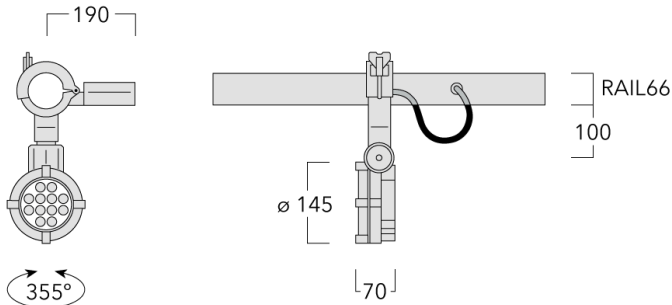

## Specifications

### Material description

|                      |   |
|----------------------|---|
| Body                 | Marine-grade, die-cast aluminium alloy  |
| Lens                 | Safety glass lens   |
| Colours              | <div style="display: flex; align-items: center;"> <div style="width: 20px; height: 15px; background-color: black; margin-right: 5px;"></div> <span>RAL9004 Signal black</span> </div> <div style="display: flex; align-items: center;"> <div style="width: 20px; height: 15px; background-color: grey; margin-right: 5px;"></div> <span>RAL9007 Grey aluminium</span> </div> <div style="display: flex; align-items: center;"> <div style="width: 20px; height: 15px; background-color: darkgrey; margin-right: 5px;"></div> <span>RAL7016 Anthracite grey</span> </div> <div style="display: flex; align-items: center;"> <div style="width: 20px; height: 15px; background-color: lightgrey; margin-right: 5px;"></div> <span>RAL9016 Traffic white</span> </div> |
| Gasket               | Silicone CCG® Controlled Compression Gasket   |
| Fasteners            | PCS hardware  |
| Ingress protection   | IP66  |
| Impact resistance    | IK07  |
| Corrosion resistance | 5CE   |

### Electrical description

|                  |   |
|------------------|---|
| Power supply     | 220-240V / 50-60 Hz   |
| Driver / Ballast | Integral EC electronic converter in thermally-separated compartment |

### Additional information

|          |                                     |
|----------|-------------------------------------|
| Lifetime | T <sub>a</sub> =25° L90B10 > 90000h |
|----------|-------------------------------------|

**Optical Accessories**

**Glare shield**

| Description     | Part ID  | A   | C1  |
|-----------------|----------|-----|-----|
| Glare shield ES | 146-0156 | 110 | 100 |



**Snoot**

| Description | Part ID  | A    | C1  |
|-------------|----------|------|-----|
| Snoot ET    | 146-0397 | 95,5 | 126 |



**Flood lens**

**FLC131 LED RAIL66**

---

| Description       | Part ID  | C1  |
|-------------------|----------|-----|
| Flood lens IO-360 | 146-0419 | 110 |

---

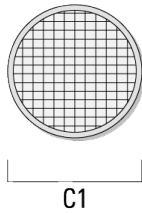

---

**Linear louvre**

---

| Description      | Part ID  | C1  |
|------------------|----------|-----|
| Linear louvre IL | 146-9055 | 110 |

---



---

**Linear spread lens**

**FLC131 LED RAIL66**

---

| Description               | Part ID  | C1  |
|---------------------------|----------|-----|
| Linear spread lens IO-180 | 146-0418 | 110 |

---

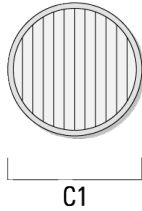

---

**Wallwash lens**

---

| Description         | Part ID  | C1  |
|---------------------|----------|-----|
| Wallwash lens IO-20 | 146-0645 | 110 |

---

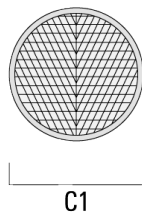

---

**Honeycomb louvre**

**FLC131 LED RAIL66**

---

| Description         | Part ID  | C1  |
|---------------------|----------|-----|
| Honeycomb louvre IW | 146-0625 | 110 |

---

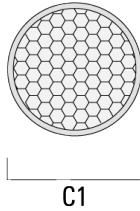

---

**Colour correction filter**

---

| Description      | Part ID  |
|------------------|----------|
| IF-3000K > 2400K | 146-9054 |

---

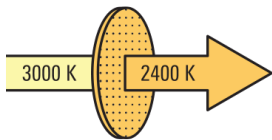

**Mounting Accessories**

**Flat Surface Fitters**

| Description            | Part ID  | C1 | C2 | D1  | D2  | L    | M1 | Weight (kg) |
|------------------------|----------|----|----|-----|-----|------|----|-------------|
| Surface fitters (pair) | 310-9290 | 20 | 30 | 180 | 140 | 1070 | 9  | 1.70        |

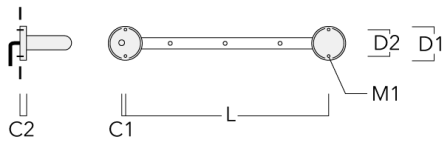

**Column Fitters**

| Description           | Part ID  | C1 | C2  | L    | M1 | Weight (kg) |
|-----------------------|----------|----|-----|------|----|-------------|
| Column fitters (pair) | 310-9294 | 30 | 100 | 1115 | 12 | 0.90        |

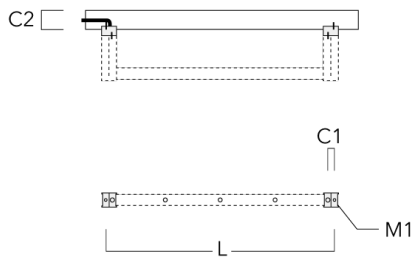

**Universal**

**FLC131 LED RAIL66**

| Description              | Part ID  | C1 | C2 | H1  | M1 | Weight (kg) | L1   | L2   |
|--------------------------|----------|----|----|-----|----|-------------|------|------|
| 2 Mains outlets (L=1150) | 310-9300 | 75 | 30 | 200 | 12 | 5.90        | 1150 | 1045 |

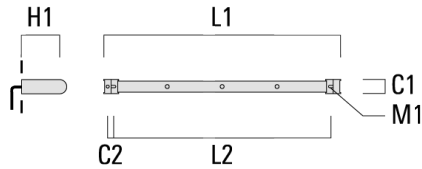

|                          |          |    |    |     |    |      |      |      |
|--------------------------|----------|----|----|-----|----|------|------|------|
| 3 Mains outlets (L=1150) | 310-9301 | 75 | 30 | 200 | 12 | 5.90 | 1150 | 1045 |
|--------------------------|----------|----|----|-----|----|------|------|------|





**FLC131 LED RAIL66**

| Description              | Part ID  | C1 | C2 | H1  | M1 | Weight (kg) | L1   | L2   |
|--------------------------|----------|----|----|-----|----|-------------|------|------|
| 3 Mains outlets (L=1650) | 310-9302 | 75 | 30 | 200 | 12 | 7.20        | 1650 | 1545 |

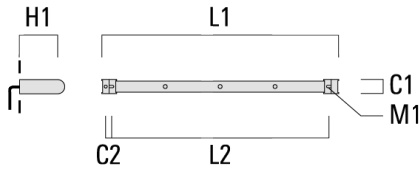

|                          |          |    |    |     |    |      |      |      |
|--------------------------|----------|----|----|-----|----|------|------|------|
| 4 Mains outlets (L=1650) | 310-9303 | 75 | 30 | 200 | 12 | 7.20 | 1650 | 1545 |
|--------------------------|----------|----|----|-----|----|------|------|------|

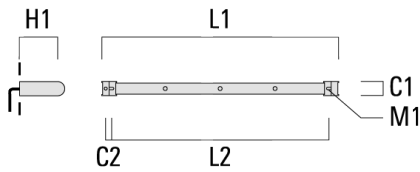

**FLC131 LED RAIL66**

| Description              | Part ID  | C1 | C2 | H1  | M1 | Weight (kg) | L1   | L2   |
|--------------------------|----------|----|----|-----|----|-------------|------|------|
| 4 Mains outlets (L=2150) | 310-9304 | 75 | 30 | 200 | 12 | 8.50        | 2150 | 2045 |

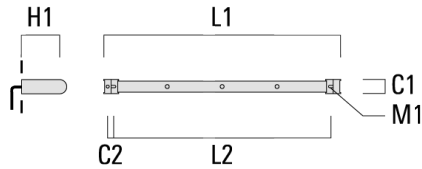

|                          |          |    |    |     |    |      |      |      |
|--------------------------|----------|----|----|-----|----|------|------|------|
| 6 Mains outlets (L=2150) | 310-9305 | 75 | 30 | 200 | 12 | 8.50 | 2150 | 2045 |
|--------------------------|----------|----|----|-----|----|------|------|------|

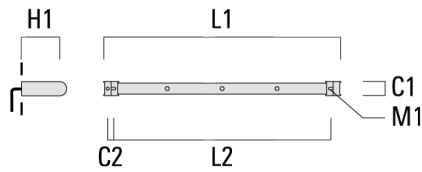

**Cantilever**

**FLC131 LED RAIL66**

| Description              | Part ID  | C1  | C2  | C3 | H1  | M1 | Weight (kg) | L1   | L2   |
|--------------------------|----------|-----|-----|----|-----|----|-------------|------|------|
| 2 Mains outlets (L=1150) | 310-9233 | 220 | 120 | 60 | 600 | 13 | 12.00       | 1150 | 1070 |

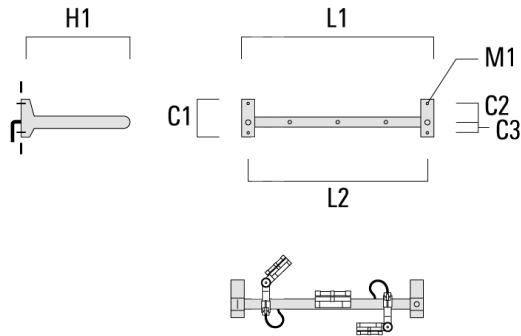

|                          |          |     |     |    |     |    |       |      |      |
|--------------------------|----------|-----|-----|----|-----|----|-------|------|------|
| 3 Mains outlets (L=1150) | 310-9234 | 220 | 120 | 60 | 600 | 13 | 12.00 | 1150 | 1070 |
|--------------------------|----------|-----|-----|----|-----|----|-------|------|------|

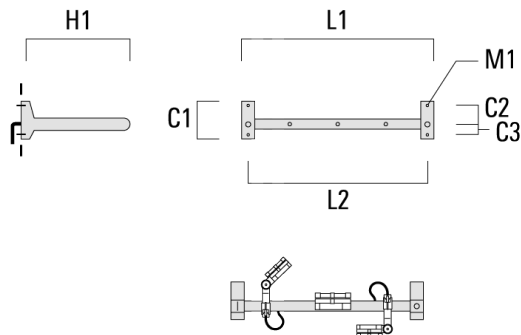

**FLC131 LED RAIL66**

| Description              | Part ID  | C1  | C2  | C3 | H1  | M1 | Weight (kg) | L1   | L2   |
|--------------------------|----------|-----|-----|----|-----|----|-------------|------|------|
| 3 Mains outlets (L=1650) | 310-9243 | 220 | 120 | 60 | 600 | 13 | 13.30       | 1650 | 1570 |

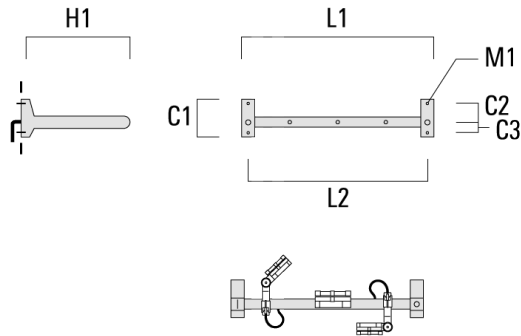

|                          |          |     |     |    |     |    |       |      |      |
|--------------------------|----------|-----|-----|----|-----|----|-------|------|------|
| 4 Mains outlets (L=1650) | 310-9244 | 220 | 120 | 60 | 600 | 13 | 13.30 | 1650 | 1570 |
|--------------------------|----------|-----|-----|----|-----|----|-------|------|------|

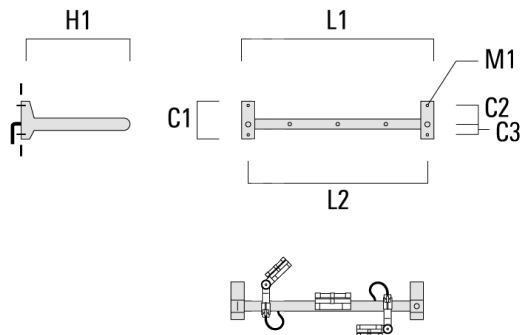

**FLC131 LED RAIL66**

| Description              | Part ID  | C1  | C2  | C3 | H1  | M1 | Weight (kg) | L1   | L2   |
|--------------------------|----------|-----|-----|----|-----|----|-------------|------|------|
| 4 Mains outlets (L=2150) | 310-9255 | 220 | 120 | 60 | 600 | 13 | 14.60       | 2150 | 2070 |

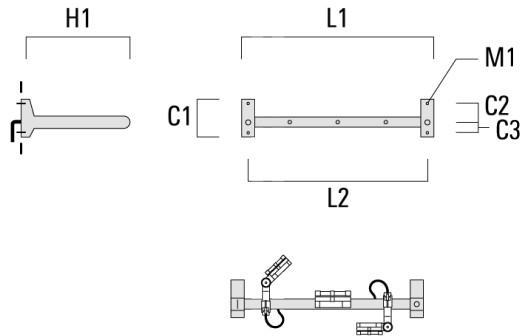

|                          |          |     |     |    |     |    |       |      |      |
|--------------------------|----------|-----|-----|----|-----|----|-------|------|------|
| 6 Mains outlets (L=2150) | 310-9256 | 220 | 120 | 60 | 600 | 13 | 14.60 | 2150 | 2070 |
|--------------------------|----------|-----|-----|----|-----|----|-------|------|------|

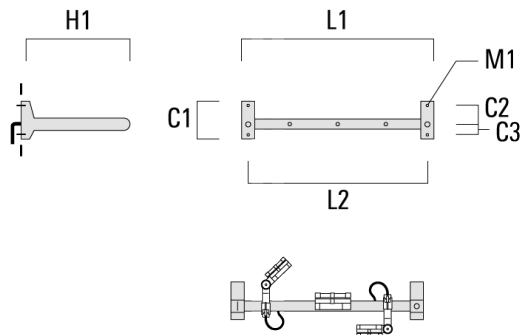

**146-0534**

**FLC131 LED RAIL66**

**WE-EF LIGHTING (Thailand) Co., Ltd.**

57 Moo 5, Kingkaew Rd., Bangplee, 10540 Samutprakarn

Phone: +66 2 738 96 20

Fax: +66 2 738 96 29

<https://we-ef.com/asia>

Subject to technical changes and errors.

Generated on 23/10/2024