



**Description**

IP66, Class I. Class II on request. IK07. Marine-grade, die-cast aluminium alloy. 5CE superior corrosion protection including PCS hardware. Silicone CCG® Controlled Compression Gasket. Safety glass lens. Integral EC electronic converter in thermally separated compartment. CAD-optimised optics for superior illumination and glare control. OLC® One LED Concept. Factory installed LED circuit board. The luminaire is factory- sealed and does not need to be opened during the installation.

Optional 2200 K version available. To be specified at time of ordering.

|                           |                                  |
|---------------------------|----------------------------------|
| Weight                    | 4.40 kg                          |
| Light distribution        | symmetric, very narrow beam [EE] |
| Light source              | LED-24/48W / 700 mA - 4000 K     |
| CRI                       | 80                               |
| Power supply              | EC                               |
| LEDs                      | 24                               |
| Rated input power         | 54 W                             |
| <b>Nominal Lumen (lm)</b> |                                  |
| LED Lumen                 | 310                              |
| Total Lumen               | 7440                             |
| Tj                        | 85                               |
| <b>Rated lumens (lm)</b>  |                                  |
| LED Lumen                 | 266.6                            |
| Total Lumen               | 6398.9                           |
| Ta                        | 25                               |

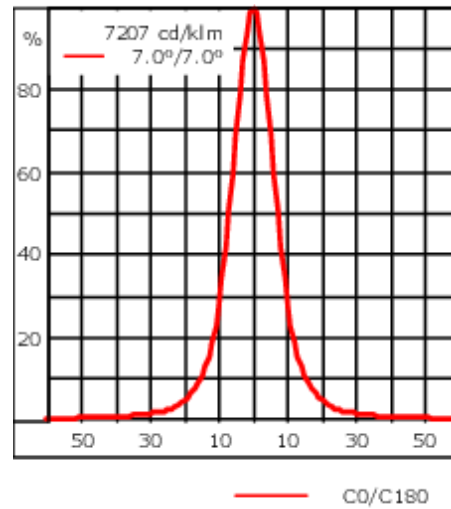
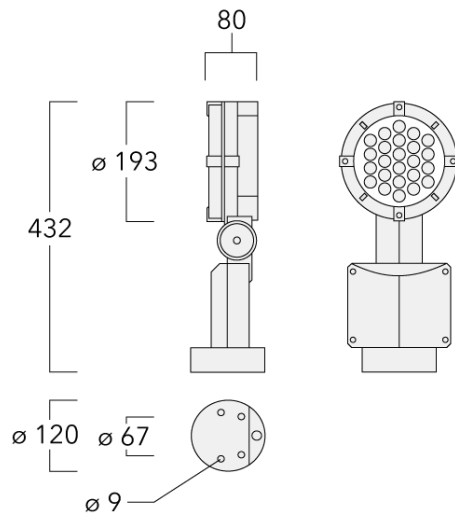

**Specifications**  
**Material description**

|                      |   |
|----------------------|---|
| Body                 | Marine-grade, die-cast aluminium alloy  |
| Lens                 | Safety glass lens   |
| Colours              | <ul style="list-style-type: none"> <li><span style="display: inline-block; width: 20px; height: 10px; background-color: black; margin-right: 5px;"></span> RAL9004 Signal black</li> <li><span style="display: inline-block; width: 20px; height: 10px; background-color: #cccccc; margin-right: 5px;"></span> RAL9006 White aluminium</li> <li><span style="display: inline-block; width: 20px; height: 10px; background-color: #808080; margin-right: 5px;"></span> RAL9007 Grey aluminium</li> <li><span style="display: inline-block; width: 20px; height: 10px; background-color: #333333; margin-right: 5px;"></span> RAL7016 Anthracite grey</li> <li><span style="display: inline-block; width: 20px; height: 10px; background-color: #e0e0e0; margin-right: 5px;"></span> RAL9016 Traffic white</li> </ul> |
| Gasket               | Silicone CCG® Controlled Compression Gasket   |
| Fasteners            | PCS Polymer Coated Stainless Steel Hardware   |
| Ingress protection   | IP66  |
| Impact resistance    | IK07  |
| Corrosion resistance | 5CE   |
| Windage              | 0.057 m <sup>2</sup>  |

**146-7065**

**FLC141 LED**

**we-ef**

### **Electrical description**

---

|                  |   |
|------------------|---|
| Power supply     | 220-240V / 50-60 Hz   |
| Driver / Ballast | Integral EC electronic converter in thermally-separated compartment |
| Surge protection | 1/2 kV  |

---

### **Additional information**

---

|                         |                        |
|-------------------------|------------------------|
| Lifetime                | Ta=25° L90B10 > 90000h |
| Energy efficiency class | C-D (Light source)     |

---

**Optical Accessories****Glare shield**

---

| Description     | Part ID  | A   | C1  |
|-----------------|----------|-----|-----|
| Glare shield ES | 146-0229 | 120 | 145 |

---



---

**Snoot**

---

| Description | Part ID  | A   | C1  |
|-------------|----------|-----|-----|
| Snoot ET    | 146-0398 | 120 | 145 |

---



146-7065

FLC141 LED

**we-ef**

**Linear spread lens**

---

| Description       | Part ID  | C1  |
|-------------------|----------|-----|
| IO-180-FLC141-LED | 146-0439 | 145 |

---



---

**Flood lens**

---

| Description       | Part ID  | C1  |
|-------------------|----------|-----|
| IO-360-FLC141-LED | 146-0624 | 145 |

---

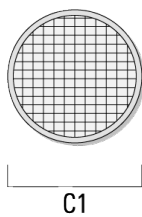

---

**Fagerhult Lighting Ltd**

33-34 Dolben Street, SE1 0UQ London, United Kingdom

<https://we-ef.com/uk>

Subject to technical changes and errors. - Generated on 05/10/2025

146-7065

FLC141 LED

**we-ef**

### Wallwash lens

---

| Description         | Part ID  | C1  |
|---------------------|----------|-----|
| IO-20-WW-FLC141-LED | 146-0646 | 145 |

---



---

### Honeycomb louvre

---

| Description               | Part ID  | C1  |
|---------------------------|----------|-----|
| IW-FLC141-LED - [EE][EES] | 146-0626 | 145 |

---



---

#### Fagerhult Lighting Ltd

33-34 Dolben Street, SE1 0UQ London, United Kingdom

<https://we-ef.com/uk>

Subject to technical changes and errors. - Generated on 05/10/2025

## Mounting Accessories

### Pipe clamp SP

| Description                           | Part ID  | D1    | Weight (kg) | D     |
|---------------------------------------|----------|-------|-------------|-------|
| SP1-2/M8 Pole clamp, single (Ø 76-89) | 146-0246 | 76-89 | 1.20        | 76-89 |



|                                       |          |       |   |       |
|---------------------------------------|----------|-------|---|-------|
| SP2-2/M8 Pole clamp, double (Ø 38-60) | 146-0247 | 38-60 | 1 | 38-66 |
|---------------------------------------|----------|-------|---|-------|



146-7065

FLC141 LED

**we-ef**

---

| Description                           | Part ID  | D1    | Weight (kg) | D     |
|---------------------------------------|----------|-------|-------------|-------|
| SP2-2/M8 Pole clamp, double (Ø 76-89) | 146-0248 | 76-89 | 1.20        | 76-89 |

---

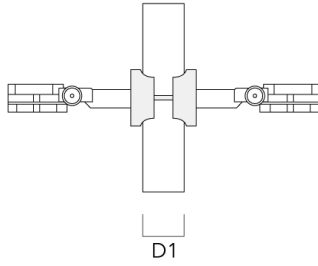

---

|                                       |          |       |   |       |
|---------------------------------------|----------|-------|---|-------|
| SP1-2/M8 Pole clamp, single (Ø 38-60) | 146-0245 | 38-60 | 1 | 38-66 |
|---------------------------------------|----------|-------|---|-------|

---



**Fagerhult Lighting Ltd**

33-34 Dolben Street, SE1 0UQ London, United Kingdom

<https://we-ef.com/uk>

Subject to technical changes and errors. - Generated on 05/10/2025



**Short post EM**

| Description | Part ID  | D1  | D2  | H1  | M1 | Weight (kg) |
|-------------|----------|-----|-----|-----|----|-------------|
| EM1-2/M8    | 146-0253 | 160 | 130 | 200 | 9  | 1.10        |



**Ground spike EF**

| Description           | Part ID  | H1  | Weight (kg) |
|-----------------------|----------|-----|-------------|
| Ground spike EF1-2/M8 | 146-0251 | 270 | 0.40        |

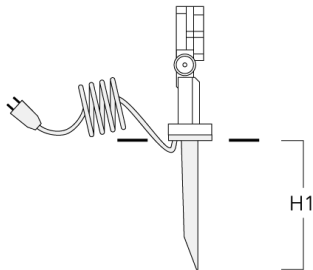

**Planted root**

| Description       | Part ID  | D1  | D2  | D3  | D4  | H1  | H2  | M1 | Weight(kg) |
|-------------------|----------|-----|-----|-----|-----|-----|-----|----|------------|
| Planted root ESV4 | 300-0461 | 145 | 130 | 102 | 108 | 400 | 350 | 8  | 7.85       |

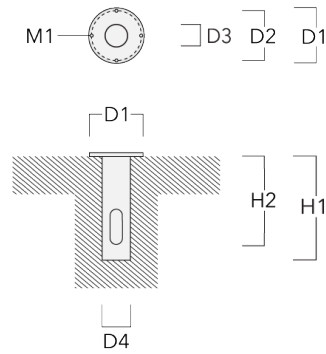

**Junction box JB1**

| Description      | Part ID  | D1  | D2 | M1 | Weight(kg) |
|------------------|----------|-----|----|----|------------|
| JB1 Junction box | 310-9000 | 135 | 67 | 9  | 1.6        |

