

146-7066

FLC141 LED Wall bracket

**we-ef**



#### Description

IP55, Class I, IK07. Marine-grade, all-aluminium construction. 5CE superior corrosion protection including PCS hardware. Safety glass lens. Silicone CCG® Controlled Compression Gasket.

Integral EC electronic converter in thermally-separated compartment. Advanced thermal management protects LEDs while optimising lumens output. CAD-optimised optics for superior illumination and glare control. OLC® One LED Concept. Two cable entries.

Knuckle permits 350° horizontal and 180° vertical aiming of optics.

Weight	5.80 kg
Light distribution	symmetric, wide beam [B]
Light source	LED-24/48W / 700 mA - 3000 K
CRI	80
Power supply	EC
LEDs	24
Rated input power	54 W
<b>Nominal Lumen (lm)</b>	
LED Lumen	290
Total Lumen	6960
Tj	85
<b>Rated lumens (lm)</b>	
LED Lumen	224.5
Total Lumen	5388.5
Ta	25

**WE-EF LIGHTING (Thailand) Co., Ltd.**

57 Moo 5, Kingkaew Rd., Bangplee, 10540 Samutprakarn - Phone: +66 2 738 96 20 - Fax: +66 2 738 96 29

<https://we-ef.com/asia>

Subject to technical changes and errors. - Generated on 23/11/2024

146-7066



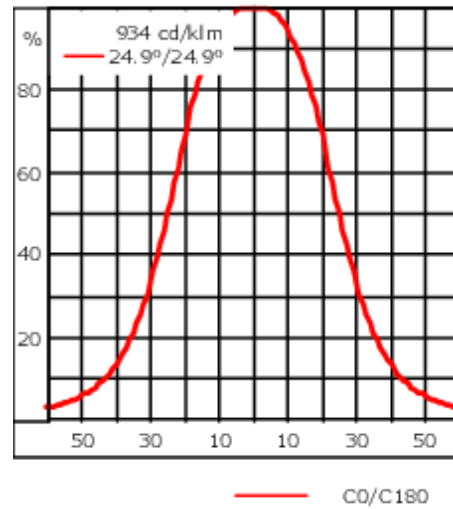
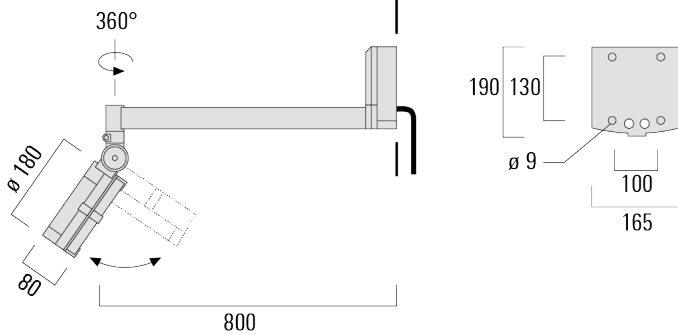

**we-ef**

**FLC141 LED Wall bracket**



**Specifications**

**Material description**

Body	Marine-grade, all-aluminium construction
Lens	Safety glass lens
Colours	 RAL9004 Signal black  RAL9007 Grey aluminium  RAL7016 Anthracite grey  RAL9016 Traffic white
Gasket	Silicone CCG® Controlled Compression Gasket
Fasteners	PCS hardware
Ingress protection	IP55
Impact resistance	IK07
Corrosion resistance	5CE

**Electrical description**

Power supply	220-240V / 50-60 Hz
Driver / Ballast	Integral EC electronic converter in thermally-separated compartment

**Additional information**

Lifetime	Ta=25° L90B10 > 90000h
----------	------------------------

**WE-EF LIGHTING (Thailand) Co., Ltd.**

57 Moo 5, Kingkaew Rd., Bangplee, 10540 Samutprakarn - Phone: +66 2 738 96 20 - Fax: +66 2 738 96 29

<https://we-ef.com/asia>

Subject to technical changes and errors. - Generated on 23/11/2024

**Optical Accessories**

**Glare shield**

Description	Part ID	A	C1
Glare shield ES	146-0229	120	145



**Snoot**

Description	Part ID	A	C1
Snoot ET	146-0398	120	145



**FLC141 LED Wall bracket**

**Linear louvre**

---

Description	Part ID	C1
Linear louvre IL	146-9056	145

---



---

**Honeycomb louvre**

---

Description	Part ID	C1
Honeycomb louvre IW	146-0626	145

---

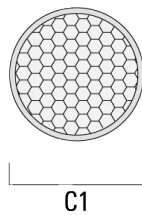

**146-7066**

**FLC141 LED Wall bracket**

**we-ef**

**Colour correction filter**

---

Description	Part ID
IF-3000K > 2400K	146-9058

---

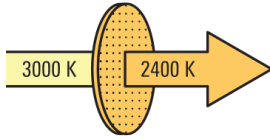

**WE-EF LIGHTING (Thailand) Co., Ltd.**

57 Moo 5, Kingkaew Rd., Bangplee, 10540 Samutprakarn - Phone: +66 2 738 96 20 - Fax: +66 2 738 96 29

<https://we-ef.com/asia>

Subject to technical changes and errors. - Generated on 23/11/2024