



### Description

IP66, Class I. IK07. Marine-grade, die-cast aluminium alloy. 5CE superior corrosion protection including PCS hardware. Safety glass lens. Silicone CCG® Controlled Compression Gasket. Luminaire is factory-sealed and does not need to be opened during installation.

Integral EC electronic converter in thermally-separated compartment. Advanced thermal management protects LEDs while optimising lumens output. CAD-optimised optics for superior illumination and glare control. OLC® One LED Concept.

Including 0.4 m of flexible cable enclosed in a stainless conduit, in-line connector and mounting clamp for installation to RAIL66 mounting system.

Weight	4.70 kg
Light distribution	symmetric, very narrow beam [EE]
Light source	LED-24/48W / 700 mA - 3000 K
CRI	80
Power supply	EC
LEDs	24
Rated input power	54 W
<b>Nominal Lumen (lm)</b>	
LED Lumen	290
Total Lumen	6960
Tj	85
<b>Rated lumens (lm)</b>	
LED Lumen	249.4
Total Lumen	5986.1
Ta	25

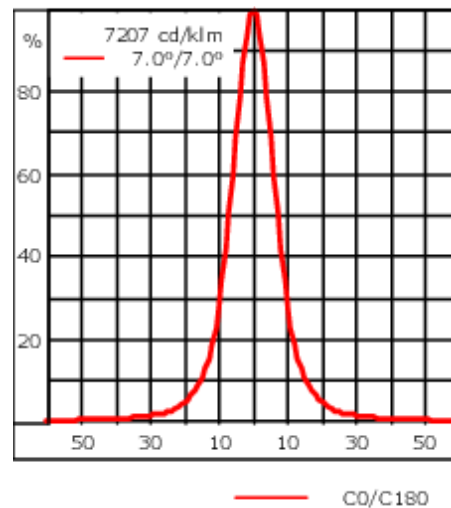
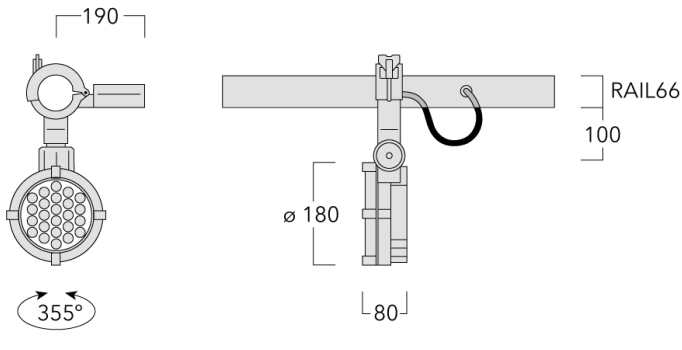

## Specifications

### Material description

Body	Marine-grade, die-cast aluminium alloy
Lens	Safety glass lens
Colours	<div style="display: flex; align-items: center;"> <div style="width: 20px; height: 15px; background-color: black; margin-right: 5px;"></div> <span>RAL9004 Signal black</span> </div> <div style="display: flex; align-items: center; margin-top: 5px;"> <div style="width: 20px; height: 15px; background-color: grey; margin-right: 5px;"></div> <span>RAL9007 Grey aluminium</span> </div> <div style="display: flex; align-items: center; margin-top: 5px;"> <div style="width: 20px; height: 15px; background-color: darkgrey; margin-right: 5px;"></div> <span>RAL7016 Anthracite grey</span> </div> <div style="display: flex; align-items: center; margin-top: 5px;"> <div style="width: 20px; height: 15px; background-color: lightgrey; margin-right: 5px;"></div> <span>RAL9016 Traffic white</span> </div>
Gasket	Silicone CCG® Controlled Compression Gasket
Fasteners	PCS hardware
Ingress protection	IP66
Impact resistance	IK07
Corrosion resistance	5CE

### Electrical description

Power supply	220-240V / 50-60 Hz
Driver / Ballast	Integral EC electronic converter in thermally-separated compartment

### Additional information

Lifetime	T <sub>a</sub> =25° L90B10 > 90000h
----------	-------------------------------------

**Optical Accessories**

**Glare shield**

Description	Part ID	A	C1
Glare shield ES	146-0229	120	145



**Snoot**

Description	Part ID	A	C1
Snoot ET	146-0398	120	145



**FLC141 LED RAIL66**

**Linear louvre**

---

Description	Part ID	C1
Linear louvre IL	146-9056	145

---



---

**Honeycomb louvre**

---

Description	Part ID	C1
Honeycomb louvre IW	146-0626	145

---



**146-7072**

**FLC141 LED RAIL66**

**we-ef**

**Colour correction filter**

---

Description	Part ID
IF-3000K > 2400K	146-9058

---

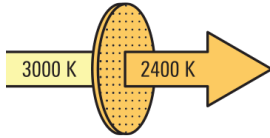

**WE-EF LIGHTING (Thailand) Co., Ltd.**

57 Moo 5, Kingkaew Rd., Bangplee, 10540 Samutprakarn - Phone: +66 2 738 96 20 - Fax: +66 2 738 96 29

<https://we-ef.com/asia>

Subject to technical changes and errors. - Generated on 23/11/2024

**Mounting Accessories**

**Flat Surface Fitters**

Description	Part ID	C1	C2	D1	D2	L	M1	Weight (kg)
Surface fitters (pair)	310-9290	20	30	180	140	1070	9	1.70



**Universal**

Description	Part ID	C1	C2	H1	M1	Weight (kg)	L1	L2
2 Mains outlets (L=1150)	310-9300	75	30	200	12	5.90	1150	1045

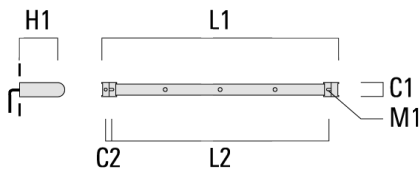

**FLC141 LED RAIL66**

Description	Part ID	C1	C2	H1	M1	Weight (kg)	L1	L2
3 Mains outlets (L=1150)	310-9301	75	30	200	12	5.90	1150	1045

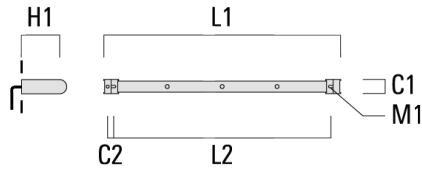

3 Mains outlets (L=1650)	310-9302	75	30	200	12	7.20	1650	1545
--------------------------	----------	----	----	-----	----	------	------	------



**FLC141 LED RAIL66**

Description	Part ID	C1	C2	H1	M1	Weight (kg)	L1	L2
4 Mains outlets (L=1650)	310-9303	75	30	200	12	7.20	1650	1545

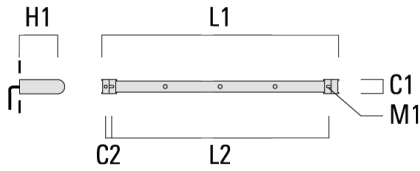

4 Mains outlets (L=2150)	310-9304	75	30	200	12	8.50	2150	2045
--------------------------	----------	----	----	-----	----	------	------	------

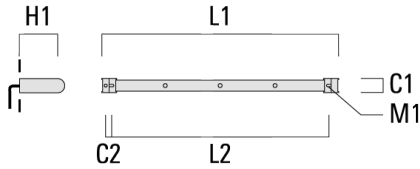



**FLC141 LED RAIL66**

Description	Part ID	C1	C2	H1	M1	Weight (kg)	L1	L2
6 Mains outlets (L=2150)	310-9305	75	30	200	12	8.50	2150	2045



**Cantilever**

Description	Part ID	C1	C2	C3	H1	M1	Weight (kg)	L1	L2
2 Mains outlets (L=1150)	310-9233	220	120	60	600	13	12.00	1150	1070

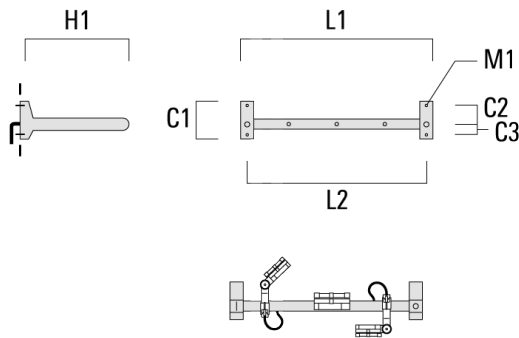

**FLC141 LED RAIL66**

Description	Part ID	C1	C2	C3	H1	M1	Weight (kg)	L1	L2
3 Mains outlets (L=1150)	310-9234	220	120	60	600	13	12.00	1150	1070

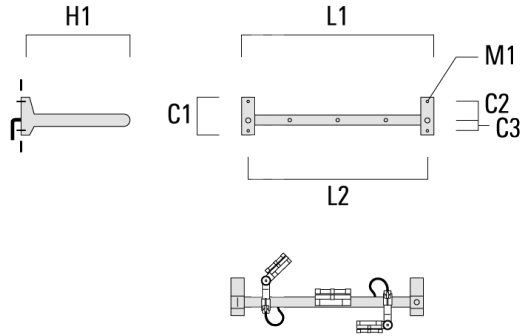

3 Mains outlets (L=1650)	310-9243	220	120	60	600	13	13.30	1650	1570
--------------------------	----------	-----	-----	----	-----	----	-------	------	------

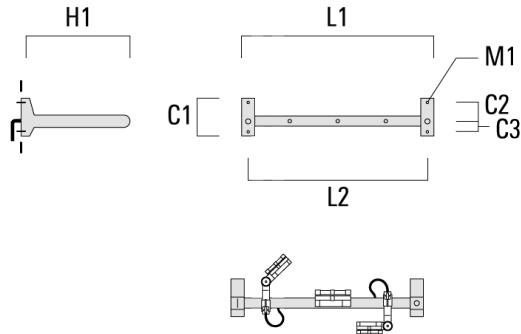

**FLC141 LED RAIL66**

Description	Part ID	C1	C2	C3	H1	M1	Weight (kg)	L1	L2
4 Mains outlets (L=1650)	310-9244	220	120	60	600	13	13.30	1650	1570

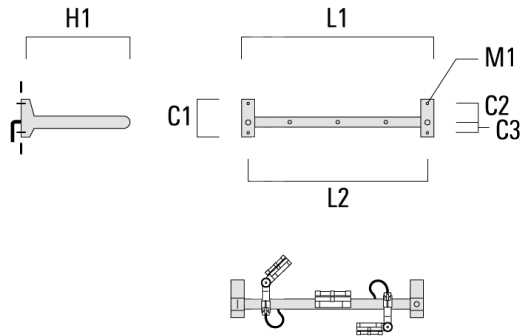

4 Mains outlets (L=2150)	310-9255	220	120	60	600	13	14.60	2150	2070
--------------------------	----------	-----	-----	----	-----	----	-------	------	------



**FLC141 LED RAIL66**

Description	Part ID	C1	C2	C3	H1	M1	Weight (kg)	L1	L2
6 Mains outlets (L=2150)	310-9256	220	120	60	600	13	14.60	2150	2070

