



Description

IP66, Class I. Class II on request. IK08. Marine-grade, die-cast aluminium alloy. 5CE superior corrosion protection including PCS hardware. Silicone CCG® Controlled Compression Gasket. RFC® Reflection Free Contour main lens. Integral EC electronic converter in thermally separated compartment. DALI. CAD-optimised optics for superior illumination and glare control. OLC® One LED Concept. Factory installed LED circuit board. The luminaire is factory-sealed and does not need to be opened during installation.

Optional 2200 K version up to max. 1050mA available. To be specified at time of ordering.

Eco Step Dim® up to 1050 mA on request.

Brackets to be ordered separately.

| | |
|--------------------|--------------------------------|
| Weight | 14.00 kg |
| Light distribution | asymmetric, side throw [S70] |
| Light source | LED-36/108W / 1050 mA - 4000 K |
| CRI | 80 |
| Power supply | EC |
| LEDs | 36 |
| Rated input power | 119 W |

Nominal Lumen (lm)

| | |
|-------------|-------|
| LED Lumen | 450 |
| Total Lumen | 16200 |
| Tj | 85 |

Rated lumens (lm)

| | |
|-------------|---------|
| LED Lumen | 394.9 |
| Total Lumen | 14217.3 |
| Ta | 25 |

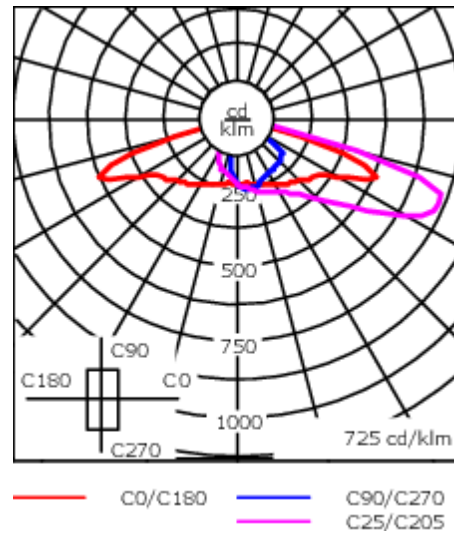
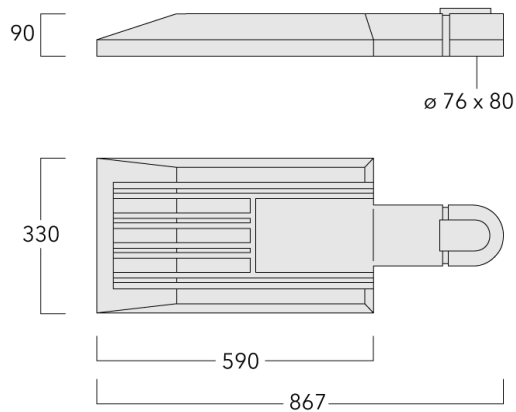

Specifications

Material description

| | |
|----------------------|--|
| Body | Marine-grade, die-cast aluminium alloy |
| Lens | RFC® Reflection Free Contour technology |
| Colours | <div style="display: flex; align-items: center;"> <div style="width: 20px; height: 15px; background-color: black; margin-right: 5px;"></div> RAL9004 Signal black </div> <div style="display: flex; align-items: center; margin-top: 5px;"> <div style="width: 20px; height: 15px; background-color: #cccccc; margin-right: 5px;"></div> RAL9006 White aluminium </div> <div style="display: flex; align-items: center; margin-top: 5px;"> <div style="width: 20px; height: 15px; background-color: #808080; margin-right: 5px;"></div> RAL9007 Grey aluminium </div> <div style="display: flex; align-items: center; margin-top: 5px;"> <div style="width: 20px; height: 15px; background-color: #333333; margin-right: 5px;"></div> RAL7016 Anthracite grey </div> <div style="display: flex; align-items: center; margin-top: 5px;"> <div style="width: 20px; height: 15px; background-color: #e0e0e0; margin-right: 5px;"></div> RAL9016 Traffic white </div> |
| Gasket | Silicone CCG® Controlled Compression Gasket |
| Fasteners | PCS Polymer Coated Stainless Steel Hardware |
| Ingress protection | IP66 |
| Impact resistance | IK08 |
| Corrosion resistance | 5CE |
| Windage | 0.23 |

Electrical description

| | |
|------------------|--|
| Power supply | 220-240V / 50-60 Hz |
| Driver / Ballast | Integral EC electronic converter. DALI |
| Power factor | > 0.9 |
| Surge protection | 6/6 kV (optional SP10) |

WE-EF LEUCHTEN GmbH

Töpinger Straße 16, 29646 Bispingen, Germany - Phone: +49 5194 909-0
 info@we-ef.com - <https://we-ef.com>

Subject to technical changes and errors. - Generated on 23/11/2024

108-0826

PFL540 LED

we-ef

Additional information

Lifetime Ta=25° L90B10 > 90000h

Energy efficiency class C-D (Light source)

WE-EF LEUCHTEN GmbH

Töpinger Straße 16, 29646 Bispingen, Germany - Phone: +49 5194 909-0
info@we-ef.com - <https://we-ef.com>

Subject to technical changes and errors. - Generated on 23/11/2024

Control

Eco Step Dim® Basic

| Description | Part ID |
|-------------------------|----------|
| Eco Step Dim® Basic LED | 430-0001 |

Eco Step Dim® Advanced

| Description | Part ID |
|----------------------------|----------|
| Eco Step Dim® Advanced LED | 430-0002 |

Eco Step Dim® Motion

| Description | Part ID |
|-------------------------------|----------|
| Eco Step Dim® Motion - Linked | 430-0021 |

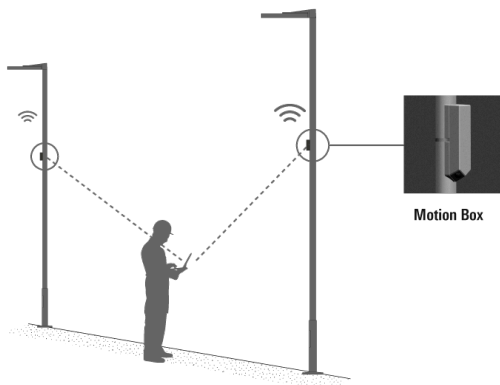

R2C Ready to Connect

| Description | Part ID |
|--------------------------------------|----------|
| R2C Ready to Connect (top) | 430-0019 |
| R2C Ready to Connect (below) | 430-0027 |
| R2C Ready to Connect (top and below) | 430-0032 |

Citygrid Motion On Pole

| Description | Part ID | Additional information |
|---------------------------------|----------|--|
| Citygrid Motion - Entry-Package | 420-0011 | Citygrid Motion. Das All-in-One Gerät, das vorhandene Leuchten in ein intelligentes Lichtsystem verwandeln kann. |

Einstiegs-Paket

WE-EF liefert und konfiguriert Leuchten und Citygrid System einmalig ab Werk bzw. am Einsatzort. Neukonfiguration als Service abrufbar (kostenpflichtig). Gateway/App nicht inbegriffen.

Anwendungen: Kommunale Einzelprojekte, Insellösungen und Feldversuche für Smart Lighting, z.B. einzelne Straßen, Wege oder Plätze. Halböffentliche oder private Projekte, z.B. Firmengelände, Parkplatz.



| Description | Part ID | Additional information |
|--------------------------------------|----------|---|
| Citygrid Motion - Standalone-Package | 420-0012 | <p>Citygrid Motion On Pole Controller.</p> <p>The Citygrid Motion On Pole Controller is the all-in-one device that can convert existing luminaires into an intelligent lighting system.</p> <p>The standalone package:</p> <p>Dongle & apps included; operators can configure, change and service the Citygrid system themselves (on site) using the apps on their mobile device.</p> <p>Applications: demarcated communal projects (street, square, district) or private projects (larger company sites, commercial estates) if qualified personnel are available for the operation of the system.</p> |



| Description | Part ID | Additional information |
|--------------------------------------|----------|--|
| Citygrid Motion - Smart-City-Package | 420-0013 | <p>Citygrid Motion On Pole Controller</p> <p>The Citygrid Motion On Pole Controller is the all-in-one device that can convert existing luminaires into an intelligent lighting system.</p> <p>The Smart-City package: Internet gateway (via mobile phone) and dashboard included; operators can configure, change and service themselves (remotely). Networked Smart-City functions (data collection, remote maintenance, etc.).</p> <p>Applications: larger communal projects or field trials in the context of Smart City; operator has qualified personnel (municipal utilities).</p> |



Citygrid Motion On Luminaire

| Description | Part ID | Additional information |
|---------------------------------|----------|---|
| Citygrid Motion - Entry-Package | 420-0021 | <p>Citygrid On Luminaire - Entry Package Citygrid On Luminaire. Die Sensoren erkennen Bewegung und Verkehr beim Betreten des Sensor und Leuchtenfelds.</p> <p>Einstiegs-Paket WE-EF liefert und konfiguriert Leuchten und Citygrid System einmalig ab Werk bzw. am Einsatzort. Neukonfiguration als Service abrufbar (kostenpflichtig). Gateway/App nicht inbegriffen.</p> <p>Anwendungen: Kommunale Einzelprojekte, Insellösungen und Feldversuche für Smart Lighting, z.B. einzelne Straßen, Wege oder Plätze. Halböffentliche oder private Projekte, z.B. Firmengelände, Parkplatz. Citygrid built-in light controller with angled sensors The sensors detect motion and traffic on entering the sensor and lighting field.</p> <p>The entry-level package: WE-EF supplies and configures luminaires and the Citygrid system once ex works or on site. Reconfiguration is available as a service (chargeable). Gateway/app not included.</p> <p>Applications: individual communal projects, isolated solutions and field trials for smart lighting, e.g. single streets, paths or squares. Semi-public or private projects, e.g. company site, car park.</p> |

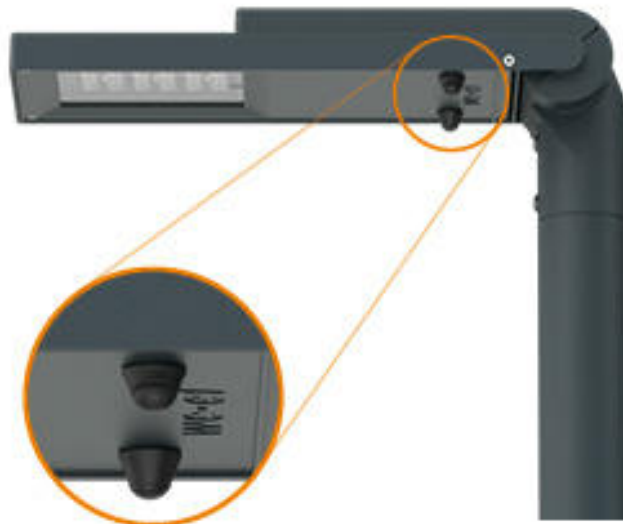

| Description | Part ID | Additional information |
|--------------------------------------|----------|---|
| Citygrid Motion - Standalone-Package | 420-0022 | <p>Citygrid Motion built-in light controller with angled sensors The sensors detect motion and traffic on entering the sensor and lighting field.</p> <p>The standalone package: Dongle & apps included; operators can configure, change and service the Citygrid system themselves (on site) using the apps on their mobile device. Applications: demarcated communal projects (street, square, district) or private projects (larger company sites, commercial estates) if qualified personnel are available for the operation of the system.</p> |

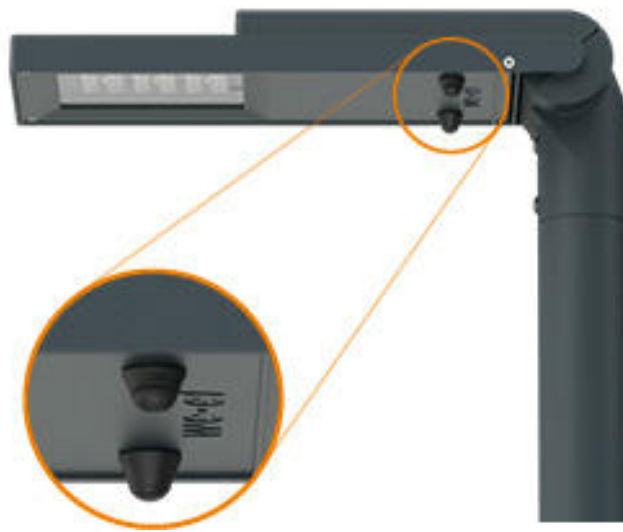

| Description | Part ID | Additional information |
|--------------------------------------|----------|--|
| Citygrid Motion - Smart-City-Package | 420-0023 | <p>Citygrid Motion built-in light controller with angled sensors The sensors detect motion and traffic on entering the sensor and lighting field.</p> <p>The Smart-City package: Internet gateway (via mobile phone) and dashboard included; operators can configure, change and service themselves (remotely). Networked Smart-City functions (data collection, remote maintenance, etc.). Applications: larger communal projects or field trials in the context of Smart City; operator has qualified personnel (municipal utilities).</p> |



Citygrid Motion Zhaga

| Description | Part ID | Additional information |
|--------------------------------------|----------|--|
| Citygrid Motion - Standalone-Package | 420-0032 | <p>Citygrid Motion Zhaga controller with sensor. The compact all-in-one design turns every luminaire with a Zhaga Book 18 socket facing the street surface into motion-controlled, intelligent street & area lighting.</p> <p>The standalone package: Dongle & apps included; operators can configure, change and service the Citygrid system themselves (on site) using the apps on their mobile device. Applications: demarcated communal projects (street, square, district) or private projects (larger company sites, commercial estates) if qualified personnel are available for the operation of the system.</p> |



| Description | Part ID | Additional information |
|--------------------------------------|----------|---|
| Citygrid Motion - Smart-City-Package | 420-0033 | <p>Citygrid Motion Zhaga controller with sensor.</p> <p>The compact all-in-one design turns every luminaire with a Zhaga Book 18 socket facing the street surface into motion-controlled, intelligent street & area lighting.</p> <p>The Smart-City package: Internet gateway (via mobile phone) and dashboard included; operators can configure, change and service themselves (remotely). Networked Smart-City functions (data collection, remote maintenance, etc.).</p> <p>Applications: larger communal projects or field trials in the context of Smart City; operator has qualified personnel (municipal utilities).</p> |



Wild-Light Citygrid Motion On Pole

| Description | Part ID | Additional information |
|--|----------|---|
| Wild-Light Citygrid Motion - Entry- Package | 420-1111 | Citygrid Motion On Pole Controller. The Citygrid Motion On Pole Controller is the all-in-one device that can convert existing luminaires into an intelligent lighting system. |

The entry-level package:

WE-EF supplies and configures luminaires and the Citygrid system once ex works or on site.
Reconfiguration is available as a service (chargeable). Gateway/app not included.

Applications: individual communal projects, isolated solutions and field trials for smart
lighting, e.g. single streets, paths or squares. Semi-public or private projects, e.g. company
site, car park.



| Description | Part ID | Additional information |
|--|----------|---|
| Wild-Light Citygrid Motion - Standalone-Package | 420-1112 | <p>Citygrid Motion On Pole Controller for Wild-Light. The Citygrid Motion On Pole Controller is the all-in-one device that can convert existing luminaires into an intelligent lighting system.</p> <p>The standalone package: Dongle & apps included; operators can configure, change and service the Citygrid system themselves (on site) using the apps on their mobile device. Applications: demarcated communal projects (street, square, district) or private projects (larger company sites, commercial estates) if qualified personnel are available for the operation of the system.</p> |



| Description | Part ID | Additional information |
|---|----------|--|
| Wild-Light Citygrid Motion - Smart-City-Package | 420-1113 | <p>Citygrid Motion On Pole Controller for Wild-Light.</p> <p>The Citygrid Motion On Pole Controller is the all-in-one device that can convert existing luminaires into an intelligent lighting system.</p> <p>The Smart-City package: Internet gateway (via mobile phone) and dashboard included; operators can configure, change and service themselves (remotely). Networked Smart-City functions (data collection, remote maintenance, etc.).</p> <p>Applications: larger communal projects or field trials in the context of Smart City; operator has qualified personnel (municipal utilities).</p> |



Mounting Accessories

Wall and pole brackets RV

| Description | Part ID | Additional information | C1 | C2 | C3 | D1 | D × L1 | H1 | H2 | M1 | M2 | Weight (kg) | C | D | H |
|------------------|----------|------------------------|-----|-----|----|----|--------|-----|-----|----|----|-------------|-----|---|---|
| RV0 Wall bracket | 108-0979 | RV0 Wall bracket | 108 | 100 | 60 | | | 200 | 160 | 38 | 12 | 2.00 | 108 | | |

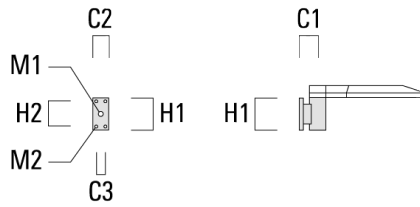

| | | | | | | | | | | | | | | | |
|-----------------------------|----------|--|-----|--|--|--|----------|--|--|--|--|------|-----|----|-----|
| RV2-76 Pole bracket, double | 108-0980 | | 147 | | | | 76 x 100 | | | | | 4.80 | 147 | 76 | 200 |
|-----------------------------|----------|--|-----|--|--|--|----------|--|--|--|--|------|-----|----|-----|

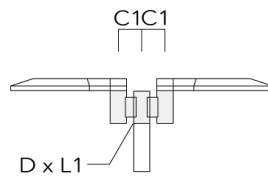

108-0826

PFL540 LED

we-ef

| Description | Part ID | Additional information | C1 | C2 | C3 | D1 | D × L1 | H1 | H2 | M1 | M2 | Weight (kg) | C | D | H |
|-----------------------------|----------|------------------------|----|----|----|----|----------|----|----|----|----|-------------|-----|----|-----|
| RV2-60 Pole bracket, double | 108-0981 | 147 | | | | | 60 x 100 | | | | | 4.80 | 147 | 60 | 200 |

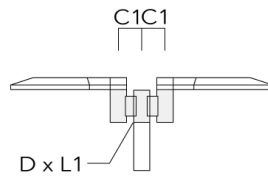

| | | | | | | | | | | | | | | | |
|------------------|----------|-----|--|--|--|--------|--|--|--|--|--|------|-----|--|-----|
| RV5 Pole bracket | 108-0982 | 108 | | | | 76-240 | | | | | | 1.70 | 106 | | 200 |
|------------------|----------|-----|--|--|--|--------|--|--|--|--|--|------|-----|--|-----|

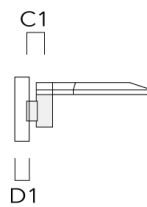

WE-EF LEUCHTEN GmbH

Töpinger Straße 16, 29646 Bispingen, Germany - Phone: +49 5194 909-0
info@we-ef.com - <https://we-ef.com>

Subject to technical changes and errors. - Generated on 23/11/2024

108-0826

PFL540 LED

we-ef

Post top fitter AKV

| Description | Part ID | C1 | D × L1 | D × L2 | H1 | Weight (kg) |
|-------------|----------|-----|--------|--------|-----|-------------|
| AKV2-76 | 300-0053 | 180 | 76x100 | 67x | 235 | 1.50 |

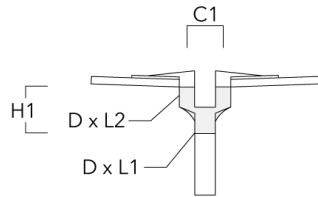

WE-EF LEUCHTEN GmbH

Töpinger Straße 16, 29646 Bispingen, Germany - Phone: +49 5194 909-0
info@we-ef.com - <https://we-ef.com>

Subject to technical changes and errors. - Generated on 23/11/2024

108-0826

PFL540 LED

we-ef

Optical Accessories

Light shield

| Description | Part ID | Additional information |
|-------------|----------|---|
| LS180-[A60] | 430-0038 | Light shield LS180 to greatly reduce or eliminate light pollution. PA injection moulded component, black matt. Suitable for asymmetric light distribution [A60]. |
| LS180 | 430-0029 | Glare Shield for backlight spill. Glare Shield factory-installed or available as retrofit kit. Suitable for [S60], [S65], [S70], [R65], [P65] lenses. Must be specified at time of ordering. |

WE-EF LEUCHTEN GmbH

Töpinger Straße 16, 29646 Bispingen, Germany - Phone: +49 5194 909-0
info@we-ef.com - <https://we-ef.com>

Subject to technical changes and errors. - Generated on 23/11/2024