

108-0828

PFL540 LED

we-ef



Description

IP66, Class I. IK08. Marine-grade, die-cast aluminium alloy. 5CE superior corrosion protection + primer including PCS hardware. Silicone CCG® Controlled Compression Gasket. PMMA RFC® Reflection Free Contour technology. LED board can be easily removed to upgrade. CAD-optimised OLC® PMMA lens for superior illumination and glare control. DALI. Optional: Side Entry (see Mounting Accessories) Optional 2200 K version up to max. 1050mA available. To be specified at time of ordering.

A professional lighting design in consultation with the relevant sections of AS/NZS-1158.4:2015 is essential for all applications with the [P45] lens.

Weight	13.00 kg
Light distribution	asymmetric, side throw [S65]
Light source	LED-24/48W / 700 mA - 4000 K
CRI	80
Power supply	EC
LEDs	24
Rated input power	54 W

Nominal Lumen (lm)

LED Lumen	310
Total Lumen	7440
Tj	85

Rated lumens (lm)

LED Lumen	281.8
Total Lumen	6763.7
Ta	25

WE-EF LIGHTING Pty Ltd

6/13 Downard Street, 3195 Braeside, Victoria - Phone: +61 3 8587 0444 - Fax: +61 3 8587 0499

info.australia@we-ef.com - <https://we-ef.com/aus>

Subject to technical changes and errors. - Generated on 23/11/2024

108-0828

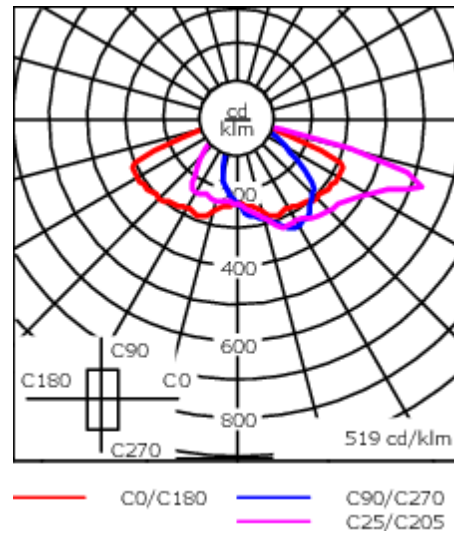
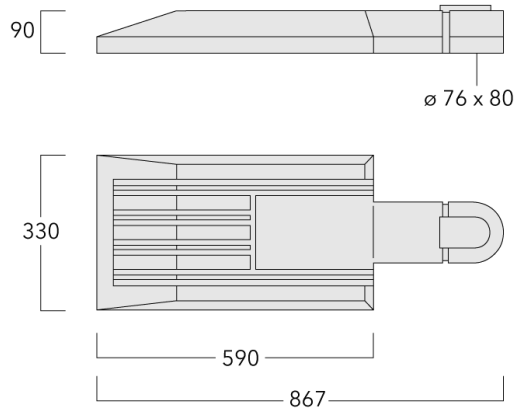

PFL540 LED

we-ef



Specifications

Material description

Body	Marine-grade, die-cast aluminium alloy
Lens	PMMA RFC® Reflection Free Contour technology
Colours	 RAL9004 Signal black  RAL9006 White aluminium  RAL9007 Grey aluminium
Gasket	Silicone CCG® Controlled Compression Gasket
Fasteners	PCS Polymer Coated Stainless Steel Hardware (unpainted)
Ingress protection	IP66
Impact resistance	IK08
Corrosion resistance	5CE+Primer
Windage	0.23

Electrical description

Power supply	230V / 50 Hz
Driver / Ballast	Integral EC electronic converter. DALI
Power factor	> 0.9
Surge protection	In-pole surge protection SP10 device supplied. Please refer to WE-EF installation instructions for details. Use suffix +A for Integral surge protection.

WE-EF LIGHTING Pty Ltd

6/13 Downard Street, 3195 Braeside, Victoria - Phone: +61 3 8587 0444 - Fax: +61 3 8587 0499

info.australia@we-ef.com - <https://we-ef.com/aus>

Subject to technical changes and errors. - Generated on 23/11/2024

108-0828

PFL540 LED

we-ef

Additional information

Lifetime Ta=40° L90B10 > 90000h

Warranty The product is supplied with 10-year warranty. Please refer to the LED Warranty Statement located on www.we-ef.com for further details.

WE-EF LIGHTING Pty Ltd

6/13 Downard Street, 3195 Braeside, Victoria - Phone: +61 3 8587 0444 - Fax: +61 3 8587 0499

info.australia@we-ef.com - <https://we-ef.com/aus>

Subject to technical changes and errors. - Generated on 23/11/2024

108-0828

PFL540 LED

we-ef

Control

Eco Step Dim® Basic

Description	Part ID
Eco Step Dim® Basic LED	430-0001

Eco Step Dim® Advanced

Description	Part ID
Eco Step Dim® Advanced LED	430-0002

R2C Ready to Connect

Description	Part ID
R2C Ready to Connect (top)	430-0019
R2C Ready to Connect (below)	430-0027
R2C Ready to Connect (top and below)	430-0032

WE-EF LIGHTING Pty Ltd

6/13 Downard Street, 3195 Braeside, Victoria - Phone: +61 3 8587 0444 - Fax: +61 3 8587 0499

info.australia@we-ef.com - <https://we-ef.com/aus>

Subject to technical changes and errors. - Generated on 23/11/2024

Mounting Accessories

Wall and pole brackets RV

Description	Part ID	Additional information	C1	C2	C3	D1	D × L1	H1	H2	M1	M2	Weight (kg)	C	D	H
RV0 Wall Bracket	108-0979	RV0 Wall bracket	108	100	60			200	160	38	12	2.00	108		

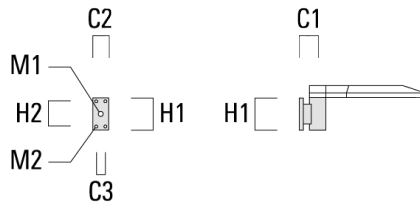

RV2-76 Pole bracket, double	108-0980		147				76 x 100					4.80	147	76	200
-----------------------------	----------	--	-----	--	--	--	----------	--	--	--	--	------	-----	----	-----

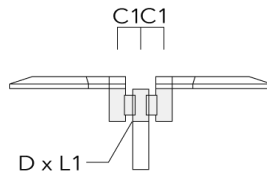

108-0828

PFL540 LED

we-ef

Description	Part ID	Additional information	C1	C2	C3	D1	D × L1	H1	H2	M1	M2	Weight (kg)	C	D	H
RV2-60 Pole bracket, double	108-0981	147					60 x 100					4.80	147	60	200

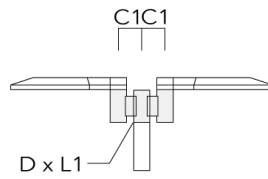

RV5 Pole bracket	108-0982	108				76-240						1.70	106		200
------------------	----------	-----	--	--	--	--------	--	--	--	--	--	------	-----	--	-----

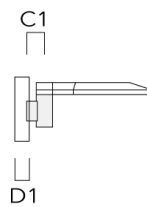

WE-EF LIGHTING Pty Ltd

6/13 Downard Street, 3195 Braeside, Victoria - Phone: +61 3 8587 0444 - Fax: +61 3 8587 0499

info.australia@we-ef.com - <https://we-ef.com/aus>

Subject to technical changes and errors. - Generated on 23/11/2024

108-0828

PFL540 LED

we-ef

Post top fitter AKV

Description	Part ID	C1	D × L1	D × L2	H1	Weight (kg)
AKV2-76	300-0053	180	76x100	67x	235	1.50

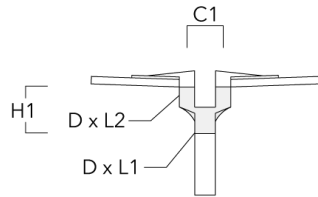

WE-EF LIGHTING Pty Ltd

6/13 Downard Street, 3195 Braeside, Victoria - Phone: +61 3 8587 0444 - Fax: +61 3 8587 0499

info.australia@we-ef.com - <https://we-ef.com/aus>

Subject to technical changes and errors. - Generated on 23/11/2024

108-0828

PFL540 LED

we-ef

Optical Accessories

Light shield

Description	Part ID	Additional information
LS180-[A60]	003-4018	Glare Shield for backlight spill. Glare Shield factory-installed or available as retrofit kit. Suitable for [A60] lenses. Must be specified at time of ordering.
LS180	003-4019	Glare Shield for backlight spill. Glare Shield factory-installed or available as retrofit kit. Suitable for [S60], [S65], [S70], [R65], [P65] lenses. Must be specified at time of ordering.

WE-EF LIGHTING Pty Ltd

6/13 Downard Street, 3195 Braeside, Victoria - Phone: +61 3 8587 0444 - Fax: +61 3 8587 0499

info.australia@we-ef.com - <https://we-ef.com/aus>

Subject to technical changes and errors. - Generated on 23/11/2024