

**108-0832**

**PFL540 LED**

**we-ef**



### Description

IP66, Class I. Class II on request. IK08. Marine-grade, die-cast aluminium alloy. 5CE superior corrosion protection including PCS hardware. Silicone CCG® Controlled Compression Gasket. RFC® Reflection Free Contour main lens. Integral EC electronic converter in thermally separated compartment. DALI. CAD-optimised optics for superior illumination and glare control. OLC® One LED Concept. Factory installed LED circuit board. The luminaire is factory-sealed and does not need to be opened during installation.

Optional 2200 K version up to max. 1050mA available. To be specified at time of ordering.

Eco Step Dim® up to 1050 mA on request.

Brackets to be ordered separately.

Weight	15.00 kg
Light distribution	asymmetric, side throw beam [S65]
Light source	LED-48/96W / 700 mA - 4000 K
CRI	80
Power supply	EC
LEDs	48
Rated input power	105.5 W

### Nominal Lumen (lm)

LED Lumen	310
Total Lumen	14880
Tj	85

### Rated lumens (lm)

LED Lumen	281.8
Total Lumen	13527.4
Ta	25

### WE-EF LEUCHTEN GmbH

Töpinger Straße 16, 29646 Bispingen, Germany - Phone: +49 5194 909-0  
info@we-ef.com - <https://we-ef.com>

Subject to technical changes and errors. - Generated on 23/11/2024

108-0832



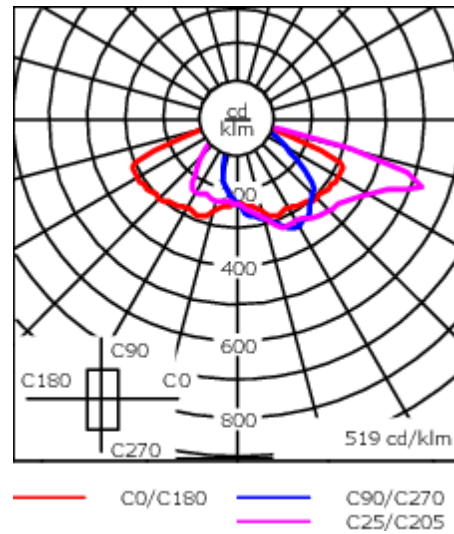
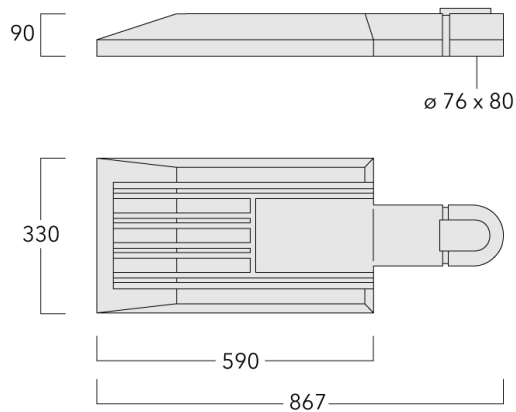

PFL540 LED

**we-ef**



## Specifications

### Material description

Body	Marine-grade, die-cast aluminium alloy
Lens	RFC® Reflection Free Contour technology
Colours	 RAL9004 Signal black  RAL9006 White aluminium  RAL9007 Grey aluminium  RAL7016 Anthracite grey  RAL9016 Traffic white
Gasket	Silicone CCG® Controlled Compression Gasket
Fasteners	PCS Polymer Coated Stainless Steel Hardware
Ingress protection	IP66
Impact resistance	IK08
Corrosion resistance	5CE
Windage	0.23

### Electrical description

Power supply	220-240V / 50-60 Hz
Driver / Ballast	Integral EC electronic converter. DALI
Power factor	> 0.9
Surge protection	6/6 kV (optional SP10)

#### WE-EF LEUCHTEN GmbH

Töpinger Straße 16, 29646 Bispingen, Germany - Phone: +49 5194 909-0  
info@we-ef.com - <https://we-ef.com>

Subject to technical changes and errors. - Generated on 23/11/2024

**108-0832**

**PFL540 LED**

**we-ef**

**Additional information**

---

Lifetime Ta=25° L90B10 > 90000h

Energy efficiency class C-D (Light source)

---

**WE-EF LEUCHTEN GmbH**

Töpinger Straße 16, 29646 Bispingen, Germany - Phone: +49 5194 909-0  
info@we-ef.com - <https://we-ef.com>

Subject to technical changes and errors. - Generated on 23/11/2024

## Control

### Eco Step Dim® Basic

Description	Part ID
Eco Step Dim® Basic LED	430-0001

### Eco Step Dim® Advanced

Description	Part ID
Eco Step Dim® Advanced LED	430-0002

### Eco Step Dim® Motion

Description	Part ID
Eco Step Dim® Motion - Linked	430-0021

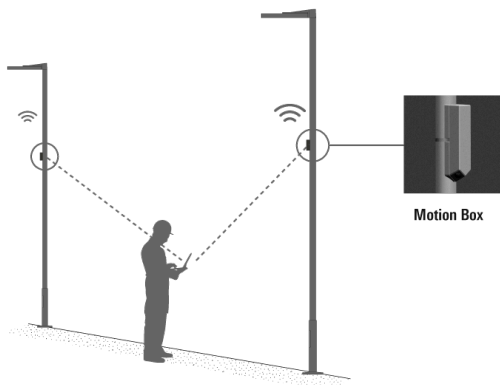

### R2C Ready to Connect

Description	Part ID
R2C Ready to Connect (top)	430-0019
R2C Ready to Connect (below)	430-0027
R2C Ready to Connect (top and below)	430-0032

**Citygrid Motion On Pole**

Description	Part ID	Additional information
Citygrid Motion - Entry-Package	420-0011	Citygrid Motion. Das All-in-One Gerät, das vorhandene Leuchten in ein intelligentes Lichtsystem verwandeln kann.

**Einstiegs-Paket**

WE-EF liefert und konfiguriert Leuchten und Citygrid System einmalig ab Werk bzw. am Einsatzort. Neukonfiguration als Service abrufbar (kostenpflichtig). Gateway/App nicht inbegriffen.

Anwendungen: Kommunale Einzelprojekte, Insellösungen und Feldversuche für Smart Lighting, z.B. einzelne Straßen, Wege oder Plätze. Halböffentliche oder private Projekte, z.B. Firmengelände, Parkplatz.



Description	Part ID	Additional information
Citygrid Motion - Standalone-Package	420-0012	<p>Citygrid Motion On Pole Controller.</p> <p>The Citygrid Motion On Pole Controller is the all-in-one device that can convert existing luminaires into an intelligent lighting system.</p> <p>The standalone package:</p> <p>Dongle &amp; apps included; operators can configure, change and service the Citygrid system themselves (on site) using the apps on their mobile device.</p> <p>Applications: demarcated communal projects (street, square, district) or private projects (larger company sites, commercial estates) if qualified personnel are available for the operation of the system.</p>



Description	Part ID	Additional information
Citygrid Motion - Smart-City-Package	420-0013	<p>Citygrid Motion On Pole Controller</p> <p>The Citygrid Motion On Pole Controller is the all-in-one device that can convert existing luminaires into an intelligent lighting system.</p> <p>The Smart-City package: Internet gateway (via mobile phone) and dashboard included; operators can configure, change and service themselves (remotely). Networked Smart-City functions (data collection, remote maintenance, etc.).</p> <p>Applications: larger communal projects or field trials in the context of Smart City; operator has qualified personnel (municipal utilities).</p>



## Citygrid Motion On Luminaire

Description	Part ID	Additional information
Citygrid Motion - Entry-Package	420-0021	<p>Citygrid On Luminaire - Entry Package Citygrid On Luminaire. Die Sensoren erkennen Bewegung und Verkehr beim Betreten des Sensor und Leuchtenfelds.</p> <p>Einstiegs-Paket WE-EF liefert und konfiguriert Leuchten und Citygrid System einmalig ab Werk bzw. am Einsatzort. Neukonfiguration als Service abrufbar (kostenpflichtig). Gateway/App nicht inbegriffen.</p> <p>Anwendungen: Kommunale Einzelprojekte, Insellösungen und Feldversuche für Smart Lighting, z.B. einzelne Straßen, Wege oder Plätze. Halböffentliche oder private Projekte, z.B. Firmengelände, Parkplatz. Citygrid built-in light controller with angled sensors The sensors detect motion and traffic on entering the sensor and lighting field.</p> <p>The entry-level package: WE-EF supplies and configures luminaires and the Citygrid system once ex works or on site. Reconfiguration is available as a service (chargeable). Gateway/app not included.</p> <p>Applications: individual communal projects, isolated solutions and field trials for smart lighting, e.g. single streets, paths or squares. Semi-public or private projects, e.g. company site, car park.</p>

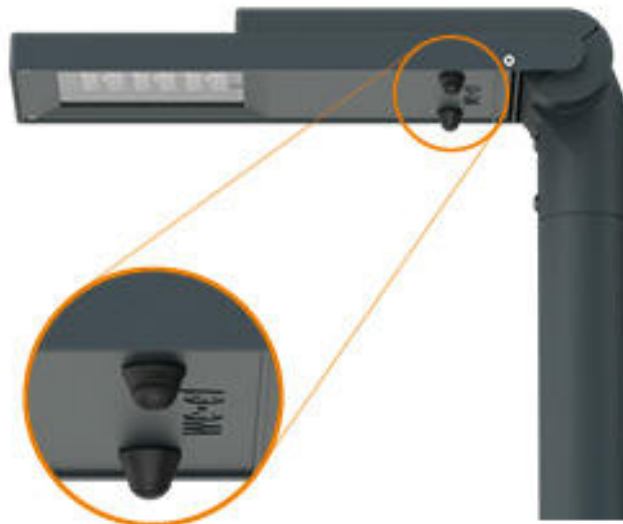



Description	Part ID	Additional information
Citygrid Motion - Standalone-Package	420-0022	<p>Citygrid Motion built-in light controller with angled sensors The sensors detect motion and traffic on entering the sensor and lighting field.</p> <p>The standalone package: Dongle &amp; apps included; operators can configure, change and service the Citygrid system themselves (on site) using the apps on their mobile device. Applications: demarcated communal projects (street, square, district) or private projects (larger company sites, commercial estates) if qualified personnel are available for the operation of the system.</p>



Description	Part ID	Additional information
Citygrid Motion - Smart-City-Package	420-0023	<p>Citygrid Motion built-in light controller with angled sensors The sensors detect motion and traffic on entering the sensor and lighting field.</p> <p>The Smart-City package: Internet gateway (via mobile phone) and dashboard included; operators can configure, change and service themselves (remotely). Networked Smart-City functions (data collection, remote maintenance, etc.). Applications: larger communal projects or field trials in the context of Smart City; operator has qualified personnel (municipal utilities).</p>



**Citygrid Motion Zhaga**

Description	Part ID	Additional information
Citygrid Motion - Standalone-Package	420-0032	<p>Citygrid Motion Zhaga controller with sensor.</p> <p>The compact all-in-one design turns every luminaire with a Zhaga Book 18 socket facing the street surface into motion-controlled, intelligent street &amp; area lighting.</p> <p>The standalone package: Dongle &amp; apps included; operators can configure, change and service the Citygrid system themselves (on site) using the apps on their mobile device.</p> <p>Applications: demarcated communal projects (street, square, district) or private projects (larger company sites, commercial estates) if qualified personnel are available for the operation of the system.</p>



Description	Part ID	Additional information
Citygrid Motion - Smart-City-Package	420-0033	<p>Citygrid Motion Zhaga controller with sensor.</p> <p>The compact all-in-one design turns every luminaire with a Zhaga Book 18 socket facing the street surface into motion-controlled, intelligent street &amp; area lighting.</p> <p>The Smart-City package: Internet gateway (via mobile phone) and dashboard included; operators can configure, change and service themselves (remotely). Networked Smart-City functions (data collection, remote maintenance, etc.).</p> <p>Applications: larger communal projects or field trials in the context of Smart City; operator has qualified personnel (municipal utilities).</p>



**Wild-Light Citygrid Motion On Pole**

Description	Part ID	Additional information
Wild-Light Citygrid Motion - Entry- Package	420-1111	Citygrid Motion On Pole Controller. The Citygrid Motion On Pole Controller is the all-in-one device that can convert existing luminaires into an intelligent lighting system.

The entry-level package:

WE-EF supplies and configures luminaires and the Citygrid system once ex works or on site.  
Reconfiguration is available as a service (chargeable). Gateway/app not included.

Applications: individual communal projects, isolated solutions and field trials for smart  
lighting, e.g. single streets, paths or squares. Semi-public or private projects, e.g. company  
site, car park.



Description	Part ID	Additional information
Wild-Light Citygrid Motion - Standalone-Package	420-1112	<p>Citygrid Motion On Pole Controller for Wild-Light. The Citygrid Motion On Pole Controller is the all-in-one device that can convert existing luminaires into an intelligent lighting system.</p> <p>The standalone package: Dongle &amp; apps included; operators can configure, change and service the Citygrid system themselves (on site) using the apps on their mobile device. Applications: demarcated communal projects (street, square, district) or private projects (larger company sites, commercial estates) if qualified personnel are available for the operation of the system.</p>



Description	Part ID	Additional information
Wild-Light Citygrid Motion - Smart-City-Package	420-1113	<p>Citygrid Motion On Pole Controller for Wild-Light.</p> <p>The Citygrid Motion On Pole Controller is the all-in-one device that can convert existing luminaires into an intelligent lighting system.</p> <p>The Smart-City package: Internet gateway (via mobile phone) and dashboard included; operators can configure, change and service themselves (remotely). Networked Smart-City functions (data collection, remote maintenance, etc.).</p> <p>Applications: larger communal projects or field trials in the context of Smart City; operator has qualified personnel (municipal utilities).</p>



**Mounting Accessories**

**Wall and pole brackets RV**

Description	Part ID	Additional information	C1	C2	C3	D1	D × L1	H1	H2	M1	M2	Weight (kg)	C	D	H
RV0 Wall bracket	108-0979	RV0 Wall bracket	108	100	60			200	160	38	12	2.00	108		

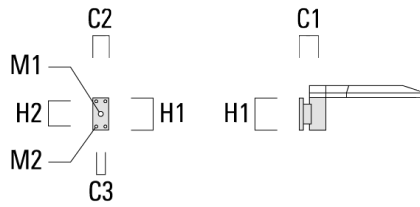

RV2-76 Pole bracket, double	108-0980		147				76 x 100					4.80	147	76	200
-----------------------------	----------	--	-----	--	--	--	----------	--	--	--	--	------	-----	----	-----

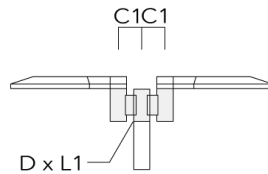



108-0832

PFL540 LED

we-ef

Description	Part ID	Additional information	C1	C2	C3	D1	D × L1	H1	H2	M1	M2	Weight (kg)	C	D	H
RV2-60 Pole bracket, double	108-0981	147					60 x 100					4.80	147	60	200

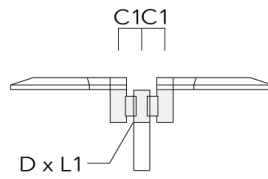

RV5 Pole bracket	108-0982	108				76-240						1.70	106		200
------------------	----------	-----	--	--	--	--------	--	--	--	--	--	------	-----	--	-----

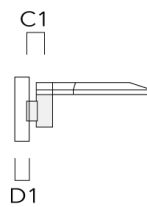

WE-EF LEUCHTEN GmbH

Töpinger Straße 16, 29646 Bispingen, Germany - Phone: +49 5194 909-0  
info@we-ef.com - <https://we-ef.com>

Subject to technical changes and errors. - Generated on 23/11/2024

108-0832

PFL540 LED

**we-ef**

**Post top fitter AKV**

Description	Part ID	C1	D × L1	D × L2	H1	Weight (kg)
AKV2-76	300-0053	180	76x100	67x	235	1.50

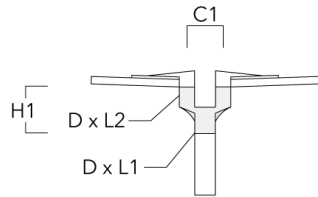

**WE-EF LEUCHTEN GmbH**

Töpinger Straße 16, 29646 Bispingen, Germany - Phone: +49 5194 909-0  
info@we-ef.com - <https://we-ef.com>

Subject to technical changes and errors. - Generated on 23/11/2024

**Optical Accessories****Light shield**

Description	Part ID	Additional information
LS180-[A60]	430-0038	Light shield LS180 to greatly reduce or eliminate light pollution. PA injection moulded component, black matt. Suitable for asymmetric light distribution [A60].
LS180	430-0029	Glare Shield for backlight spill. Glare Shield factory-installed or available as retrofit kit. Suitable for [S60], [S65], [S70], [R65], [P65] lenses. Must be specified at time of ordering.