



### Description

IP67\*, Class I. IK10+. Stainless steel construction including PCS hardware. Silicone rubber gasket. Safety glass lens; max. load 5 tonnes. Luminaire can be driven over at low speed. Factory-sealed termination chamber complete with cable gland and 1.5 m of flexible PVC free cable. Cable gland with spiral cable bending protection. Integral EC electronic converter in thermally separated compartment. 'No tool' removable gear/lens tray. CAD-optimised optics for superior illumination and glare control. OLC® One LED Concept. Factory installed LED circuit board. Gimbal mounted, 360° rotatable and 30° tiltable.

The optional installation blackout is recommended for mounting. To be ordered separately.

Optional with Anti-Slip ceramic Coating ASC to DIN 51130 (Trip Classification 10) available on request.

The luminaire is not suitable for permanent underwater operation and must be switched off in the event of flooding.

\* Additionally tested to IP66, IP67, IP68 0.1 bar 3h, up to 1 m depth according to DIN EN 60598 and IP69K/80° according to DIN EN 60529.

Weight	6.20 kg
Light distribution	symmetric, medium beam [M]
Light source	LED-12/18W / 500 mA - 4000 K
CRI	80
Power supply	EC
LEDs	12
Rated input power	21 W

### Nominal Lumen (lm)

LED Lumen	230
Total Lumen	2760
Tj	85

### Rated lumens (lm)

LED Lumen	199.6
Total Lumen	2394.8
Ta	25

### WE-EF LEUCHTEN GmbH

Töpinger Straße 16, 29646 Bispingen, Germany - Phone: +49 5194 909-0  
info@we-ef.com - <https://we-ef.com>

Subject to technical changes and errors. - Generated on 19/04/2025

185-2447

ETC130-GB LED

**we-ef**

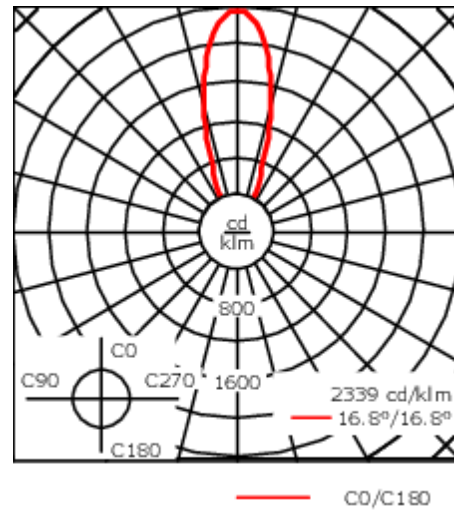
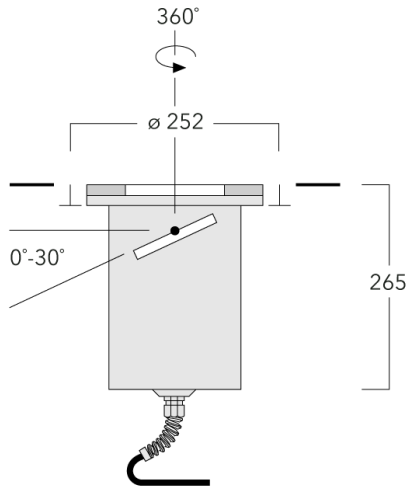

## Specifications

### Material description

Body	Stainless steel construction
Lens	Safety glass lens; max. load 5 tonnes
Colours	 Stainless Steel
Gasket	Silicone rubber gasket
Fasteners	PCS polymer coated stainless steel
Ingress protection	IP67
Impact resistance	IK10+
Corrosion resistance	5CE

### Electrical description

Power supply	220-240V / 50-60 Hz
Driver / Ballast	Integral EC electronic converter
Power factor	> 0.9
Surge protection	1/2 kV (optional SP10)

### Additional information

Lifetime	Ta=25° L90B10 > 90000h
Energy efficiency class	C-D (Light source)

#### WE-EF LEUCHTEN GmbH

Töpinger Straße 16, 29646 Bispingen, Germany - Phone: +49 5194 909-0  
info@we-ef.com - <https://we-ef.com>

Subject to technical changes and errors. - Generated on 19/04/2025

185-2447

ETC130-GB LED

**we-ef**

## Mounting Accessories

### Installation blackout

Description	Part ID	D1	D2	H1	Weight (kg)	D	H
Blockout, Plastic	185-0322	250	270	375	1.50	250/270	375

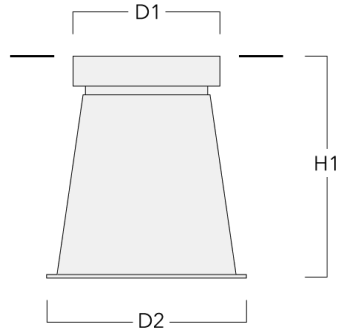

### Installation cover

Description	Part ID	C1
Installation cover BE	185-0325	250

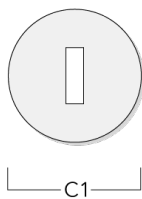

#### WE-EF LEUCHTEN GmbH

Töpinger Straße 16, 29646 Bispingen, Germany - Phone: +49 5194 909-0  
info@we-ef.com - <https://we-ef.com>

Subject to technical changes and errors. - Generated on 19/04/2025

185-2447

ETC130-GB LED

**we-ef**

## Electrical Accessories

### Sealable junction box

Description	Part ID	C1	M1	M2
Sealable junction box SJB130	185-1624	146	Ø 10	Ø 12 - 19

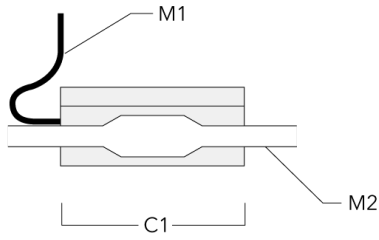

#### WE-EF LEUCHTEN GmbH

Töpinger Straße 16, 29646 Bispingen, Germany - Phone: +49 5194 909-0  
info@we-ef.com - <https://we-ef.com>

Subject to technical changes and errors. - Generated on 19/04/2025

## Optical Accessories

## Linear spread lens

Description	Part ID	Additional information	C1
IO-180 ETC130/330-GB LED	185-2632		98

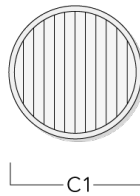

IO-180-DAC120-LED	134-2000	Broadens light distribution in one plane only. Ideally suitable for [M][EE][EES]. Does not fit in combination with [B] lens. A maximum of one internal optical accessory. Internal component, factory installed.	130
-------------------	----------	---	-----

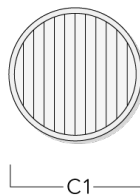

185-2447

ETC130-GB LED

**we-ef**

**Flood lens**

---

Description	Part ID	C1
IO-360-ETC130-GB-LED	185-2866	98

---

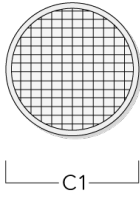

---

**Honeycomb louvre**

---

Description	Part ID	C1
IW-ETC130/330-GB-LED - [M][EE] [EES]	185-2870	98

---

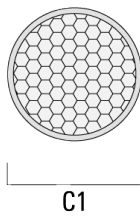

**WE-EF LEUCHTEN GmbH**

Töpinger Straße 16, 29646 Bispingen, Germany - Phone: +49 5194 909-0  
info@we-ef.com - <https://we-ef.com>

Subject to technical changes and errors. - Generated on 19/04/2025