



**Description**

IP66, Class I. Class II on request. IK08. Marine-grade, die-cast aluminium alloy. 5CE superior corrosion protection including PCS hardware. Silicone CCG® Controlled Compression Gasket. RFC® Reflection Free Contour main lens. Integral EC electronic converter in thermally separated compartment. DALI. CAD-optimised optics for superior illumination and glare control. OLC® One LED Concept. Factory installed LED circuit board. The luminaire is factory-sealed and does not need to be opened during installation.

Optional 2200 K version up to max. 1050mA available. To be specified at time of ordering.

Eco Step Dim® up to 1050 mA on request.

Brackets to be ordered separately.

Weight	14.00 kg
Light distribution	asymmetric, side throw beam [S60]
Light source	LED-36/72W / 700 mA - 4000 K
CRI	80
Power supply	EC
LEDs	36
Rated input power	79 W

**Nominal Lumen (lm)**

LED Lumen	310
Total Lumen	11160
Tj	85

**Rated lumens (lm)**

LED Lumen	279.2
Total Lumen	10051.6
Ta	25

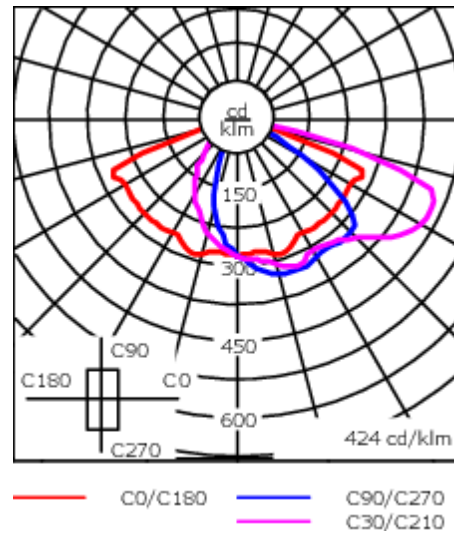
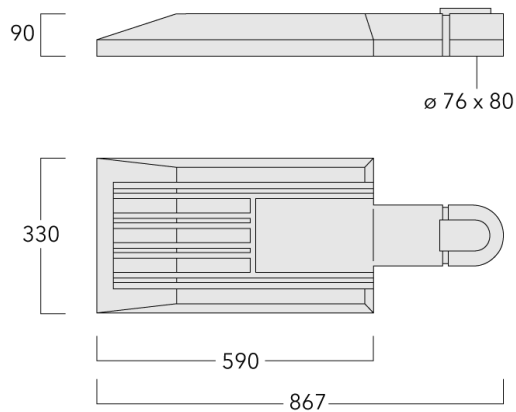

## Specifications

### Material description

Body	Marine-grade, die-cast aluminium alloy
Lens	RFC® Reflection Free Contour technology
Colours	<div style="display: flex; align-items: center; gap: 10px;"> <div style="width: 20px; height: 15px; background-color: black; margin-right: 5px;"></div> RAL9004 Signal black  <div style="width: 20px; height: 15px; background-color: #cccccc; margin-right: 5px;"></div> RAL9006 White aluminium  <div style="width: 20px; height: 15px; background-color: #808080; margin-right: 5px;"></div> RAL9007 Grey aluminium  <div style="width: 20px; height: 15px; background-color: #333333; margin-right: 5px;"></div> RAL7016 Anthracite grey  <div style="width: 20px; height: 15px; background-color: #e0e0e0; margin-right: 5px;"></div> RAL9016 Traffic white         </div>
Gasket	Silicone CCG® Controlled Compression Gasket
Fasteners	PCS Polymer Coated Stainless Steel Hardware
Ingress protection	IP66
Impact resistance	IK08
Corrosion resistance	5CE
Windage	0.23

### Electrical description

Power supply	220-240V / 50-60 Hz
Driver / Ballast	Integral EC electronic converter. DALI
Power factor	> 0.9
Surge protection	6/6 kV (optional SP10)

**108-0950**

**PFL540 LED**

**we-ef**

**Additional information**

---

Lifetime Ta=25° L90B10 > 90000h

Energy efficiency class C-D (Light source)

---

**Fagerhult Lighting Ltd**

33-34 Dolben Street, SE1 0UQ London, United Kingdom

<https://we-ef.com/uk>

Subject to technical changes and errors. - Generated on 23/11/2024

108-0950

PFL540 LED

**we-ef**

## Control

### Eco Step Dim® Basic

Description	Part ID
Eco Step Dim® Basic LED	430-0001

### Eco Step Dim® Advanced

Description	Part ID
Eco Step Dim® Advanced LED	430-0002

### Eco Step Dim® Motion

Description	Part ID
Eco Step Dim® Motion - Linked	430-0021

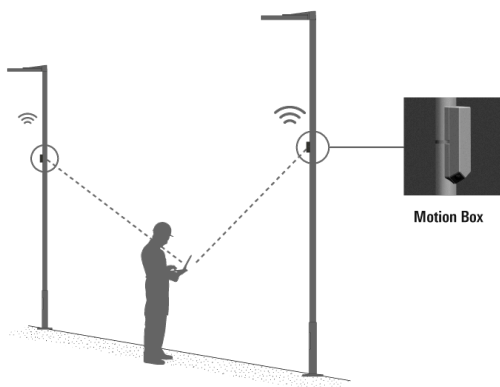

### R2C Ready to Connect

Description	Part ID
R2C Ready to Connect (top)	430-0019
R2C Ready to Connect (below)	430-0027
R2C Ready to Connect (top and below)	430-0032

#### Fagerhult Lighting Ltd

33-34 Dolben Street, SE1 0UQ London, United Kingdom

<https://we-ef.com/uk>

Subject to technical changes and errors. - Generated on 23/11/2024

**Citygrid Motion On Pole**

Description	Part ID	Additional information
Citygrid Motion - Entry-Package	420-0011	Citygrid Motion. Das All-in-One Gerät, das vorhandene Leuchten in ein intelligentes Lichtsystem verwandeln kann.

**Einstiegs-Paket**

WE-EF liefert und konfiguriert Leuchten und Citygrid System einmalig ab Werk bzw. am Einsatzort. Neukonfiguration als Service abrufbar (kostenpflichtig). Gateway/App nicht inbegriffen.

Anwendungen: Kommunale Einzelprojekte, Insellösungen und Feldversuche für Smart Lighting, z.B. einzelne Straßen, Wege oder Plätze. Halböffentliche oder private Projekte, z.B. Firmengelände, Parkplatz.



Description	Part ID	Additional information
Citygrid Motion - Standalone-Package	420-0012	<p>Citygrid Motion On Pole Controller.</p> <p>The Citygrid Motion On Pole Controller is the all-in-one device that can convert existing luminaires into an intelligent lighting system.</p> <p>The standalone package:</p> <p>Dongle &amp; apps included; operators can configure, change and service the Citygrid system themselves (on site) using the apps on their mobile device.</p> <p>Applications: demarcated communal projects (street, square, district) or private projects (larger company sites, commercial estates) if qualified personnel are available for the operation of the system.</p>



Description	Part ID	Additional information
Citygrid Motion - Smart-City-Package	420-0013	<p>Citygrid Motion On Pole Controller</p> <p>The Citygrid Motion On Pole Controller is the all-in-one device that can convert existing luminaires into an intelligent lighting system.</p> <p>The Smart-City package: Internet gateway (via mobile phone) and dashboard included; operators can configure, change and service themselves (remotely). Networked Smart-City functions (data collection, remote maintenance, etc.).</p> <p>Applications: larger communal projects or field trials in the context of Smart City; operator has qualified personnel (municipal utilities).</p>



## Citygrid Motion On Luminaire

Description	Part ID	Additional information
Citygrid Motion - Entry-Package	420-0021	<p>Citygrid On Luminaire - Entry Package Citygrid On Luminaire. Die Sensoren erkennen Bewegung und Verkehr beim Betreten des Sensor und Leuchtenfelds.</p> <p>Einstiegs-Paket WE-EF liefert und konfiguriert Leuchten und Citygrid System einmalig ab Werk bzw. am Einsatzort. Neukonfiguration als Service abrufbar (kostenpflichtig). Gateway/App nicht inbegriffen.</p> <p>Anwendungen: Kommunale Einzelprojekte, Insellösungen und Feldversuche für Smart Lighting, z.B. einzelne Straßen, Wege oder Plätze. Halböffentliche oder private Projekte, z.B. Firmengelände, Parkplatz. Citygrid built-in light controller with angled sensors The sensors detect motion and traffic on entering the sensor and lighting field.</p> <p>The entry-level package: WE-EF supplies and configures luminaires and the Citygrid system once ex works or on site. Reconfiguration is available as a service (chargeable). Gateway/app not included.</p> <p>Applications: individual communal projects, isolated solutions and field trials for smart lighting, e.g. single streets, paths or squares. Semi-public or private projects, e.g. company site, car park.</p>

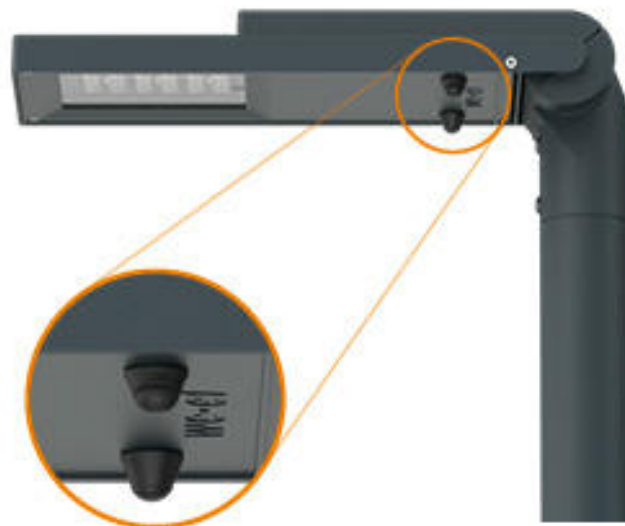



Description	Part ID	Additional information
Citygrid Motion - Standalone-Package	420-0022	<p>Citygrid Motion built-in light controller with angled sensors The sensors detect motion and traffic on entering the sensor and lighting field.</p> <p>The standalone package: Dongle &amp; apps included; operators can configure, change and service the Citygrid system themselves (on site) using the apps on their mobile device. Applications: demarcated communal projects (street, square, district) or private projects (larger company sites, commercial estates) if qualified personnel are available for the operation of the system.</p>



Description	Part ID	Additional information
Citygrid Motion - Smart-City-Package	420-0023	<p>Citygrid Motion built-in light controller with angled sensors The sensors detect motion and traffic on entering the sensor and lighting field.</p> <p>The Smart-City package: Internet gateway (via mobile phone) and dashboard included; operators can configure, change and service themselves (remotely). Networked Smart-City functions (data collection, remote maintenance, etc.). Applications: larger communal projects or field trials in the context of Smart City; operator has qualified personnel (municipal utilities).</p>



**Citygrid Motion Zhaga**

Description	Part ID	Additional information
Citygrid Motion - Standalone-Package	420-0032	Citygrid Motion Zhaga controller with sensor. The compact all-in-one design turns every luminaire with a Zhaga Book 18 socket facing the street surface into motion-controlled, intelligent street & area lighting.

The standalone package:

Dongle & apps included; operators can configure, change and service the Citygrid system themselves (on site) using the apps on their mobile device.

Applications: demarcated communal projects (street, square, district) or private projects (larger company sites, commercial estates) if qualified personnel are available for the operation of the system.



Description	Part ID	Additional information
Citygrid Motion - Smart-City-Package	420-0033	<p>Citygrid Motion Zhaga controller with sensor.</p> <p>The compact all-in-one design turns every luminaire with a Zhaga Book 18 socket facing the street surface into motion-controlled, intelligent street &amp; area lighting.</p> <p>The Smart-City package: Internet gateway (via mobile phone) and dashboard included; operators can configure, change and service themselves (remotely). Networked Smart-City functions (data collection, remote maintenance, etc.).</p> <p>Applications: larger communal projects or field trials in the context of Smart City; operator has qualified personnel (municipal utilities).</p>



**Wild-Light Citygrid Motion On Pole**

---

Description	Part ID	Additional information
Wild-Light Citygrid Motion - Entry- Package	420-1111	Citygrid Motion On Pole Controller. The Citygrid Motion On Pole Controller is the all-in-one device that can convert existing luminaires into an intelligent lighting system.

---

The entry-level package:

WE-EF supplies and configures luminaires and the Citygrid system once ex works or on site. Reconfiguration is available as a service (chargeable). Gateway/app not included.

Applications: individual communal projects, isolated solutions and field trials for smart lighting, e.g. single streets, paths or squares. Semi-public or private projects, e.g. company site, car park.



Description	Part ID	Additional information
Wild-Light Citygrid Motion - Standalone-Package	420-1112	Citygrid Motion On Pole Controller for Wild-Light. The Citygrid Motion On Pole Controller is the all-in-one device that can convert existing luminaires into an intelligent lighting system.

The standalone package:

Dongle & apps included; operators can configure, change and service the Citygrid system themselves (on site) using the apps on their mobile device.

Applications: demarcated communal projects (street, square, district) or private projects (larger company sites, commercial estates) if qualified personnel are available for the operation of the system.



Description	Part ID	Additional information
Wild-Light Citygrid Motion - Smart-City-Package	420-1113	<p>Citygrid Motion On Pole Controller for Wild-Light.</p> <p>The Citygrid Motion On Pole Controller is the all-in-one device that can convert existing luminaires into an intelligent lighting system.</p> <p>The Smart-City package: Internet gateway (via mobile phone) and dashboard included; operators can configure, change and service themselves (remotely). Networked Smart-City functions (data collection, remote maintenance, etc.).</p> <p>Applications: larger communal projects or field trials in the context of Smart City; operator has qualified personnel (municipal utilities).</p>



**Mounting Accessories**

**Wall and pole brackets RV**

Description	Part ID	Additional information	C1	C2	C3	D1	D × L1	H1	H2	M1	M2	Weight (kg)	C	D	H
RV0 Wall bracket	108-0979	RV0 Wall bracket	108	100	60			200	160	38	12	2.00	108		

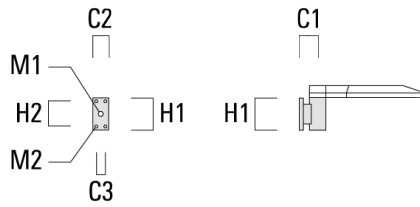

RV2-76 Pole bracket, double	108-0980		147				76 x 100					4.80	147	76	200
-----------------------------	----------	--	-----	--	--	--	----------	--	--	--	--	------	-----	----	-----

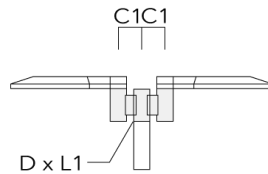



108-0950

PFL540 LED

**we-ef**

Description	Part ID	Additional information	C1	C2	C3	D1	D × L1	H1	H2	M1	M2	Weight (kg)	C	D	H
RV2-60 Pole bracket, double	108-0981	147					60 x 100					4.80	147	60	200



RV5 Pole bracket	108-0982	108				76-240						1.70	106		200
------------------	----------	-----	--	--	--	--------	--	--	--	--	--	------	-----	--	-----

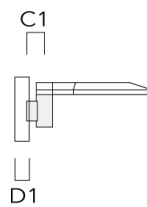

**Fagerhult Lighting Ltd**

33-34 Dolben Street, SE1 0UQ London, United Kingdom

<https://we-ef.com/uk>

Subject to technical changes and errors. - Generated on 23/11/2024

108-0950

PFL540 LED

**we-ef**

**Post top fitter AKV**

Description	Part ID	C1	D × L1	D × L2	H1	Weight (kg)
AKV2-76	300-0053	180	76x100	67x	235	1.50

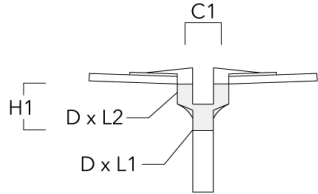

**108-0950**

**PFL540 LED**

**we-ef**

## **Optical Accessories**

### **Light shield**

Description	Part ID	Additional information
LS180-[A60]	430-0038	Light shield LS180 to greatly reduce or eliminate light pollution. PA injection moulded component, black matt. Suitable for asymmetric light distribution [A60].
LS180	430-0029	Glare Shield for backlight spill. Glare Shield factory-installed or available as retrofit kit. Suitable for [S60], [S65], [S70], [R65], [P65] lenses. Must be specified at time of ordering.