



Description

IP66, Class I. IK08. Marine-grade, die-cast aluminium alloy. 5CE superior corrosion protection including PCS hardware. RFC™ Reflection Free Contour main lens. Silicone CCG® Controlled Compression Gasket. Luminaire is factory-sealed and does not need to be opened during installation.

Integral electronic converter with DALI interface. Advanced thermal management protects LEDs while optimising lumens output. Removable LED boards for upgrading. CAD-optimised optics for superior illumination and glare control. OLC® One LED Concept. Optional 2200 K version up to max. 1050mA available. To be specified at time of ordering.

Including 0.5 m cable with a cable connector.

Maximum spacing for streetlighting applications depends on wattage and light distribution: 5.5 to 9 times the mounting height.

Wild-Light options available on request.

Weight	15.00 kg
Light distribution	asymmetric, side throw [S60]
Light source	LED-48/144W / 1050 mA - 4000 K
CRI	80
Power supply	EC
BUG	B3 U0 G3
LEDs	48
Rated input power	159 W
Nominal Lumen (lm)	
LED Lumen	450
Total Lumen	21600
Tj	85
Rated lumens (lm)	
LED Lumen	401.2
Total Lumen	19256.4
Ta	25

108-0954



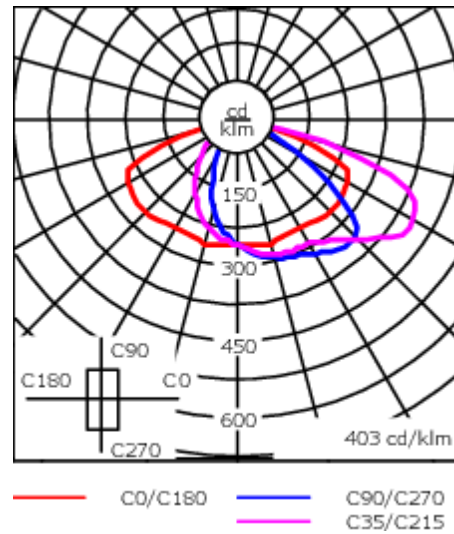
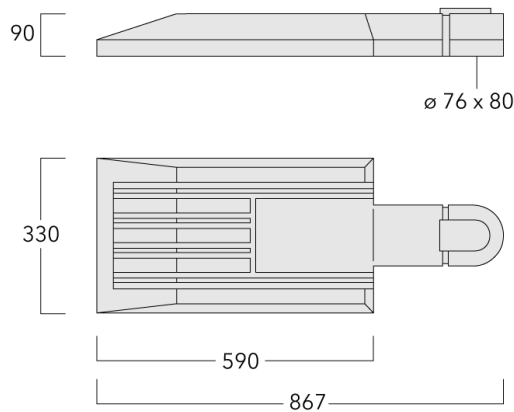

PFL540 LED

we-ef



Specifications

Material description

Body	Marine-grade, die-cast aluminium alloy
Lens	RFC™ Reflection Free Contour main lens
Colours	 RAL9004 Signal black  RAL9007 Grey aluminium  RAL7016 Anthracite grey  RAL9016 Traffic white
Gasket	Silicone CCG® Controlled Compression Gasket
Fasteners	PCS Polymer Coated Stainless Steel Hardware
Ingress protection	IP66
Impact resistance	IK08
Corrosion resistance	5CE
Windage	0.23

Electrical description

Power supply	220-240V / 50-60 Hz
Driver / Ballast	Integral electronic converter with DALI interface
Power factor	> 0.9

Additional information

Lifetime	Ta=25° L90B10 > 90000h
BUG Rating	Please see individual Spec Sheets for classification of Backlight, Uplight and Glare

WE-EF LIGHTING (Thailand) Co., Ltd.

57 Moo 5, Kingkaew Rd., Bangplee, 10540 Samutprakarn - Phone: +66 2 738 96 20 - Fax: +66 2 738 96 29

<https://we-ef.com/asia>

Subject to technical changes and errors. - Generated on 23/11/2024

Mounting Accessories

Wall and pole brackets RV

Description	Part ID	Additional information	C1	C2	C3	D1	D × L1	H1	H2	M1	M2	Weight (kg)	C	D	H
RV0 Wall bracket	108-0979-AP	RV0 Wall bracket	108	100	45			200	160	40	12	2.80	108		

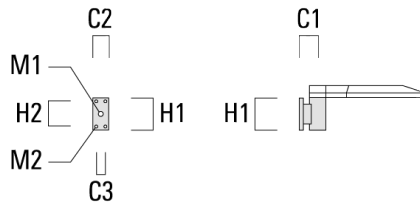

RV2-76 Pole bracket, double	108-0980		147				76 x 100					8.10	147	76	200
-----------------------------	----------	--	-----	--	--	--	----------	--	--	--	--	------	-----	----	-----

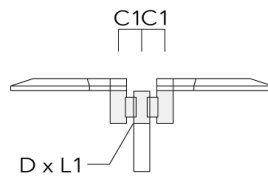

108-0954

PFL540 LED

we-ef

Description	Part ID	Additional information	C1	C2	C3	D1	D × L1	H1	H2	M1	M2	Weight (kg)	C	D	H
RV2-60 Pole bracket, double	108-0981	147					60 x 100					8.50	147	60	200

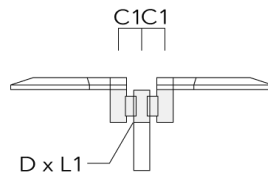

RV5 Pole bracket	108-0982	108				76-240						2.30	106		200
------------------	----------	-----	--	--	--	--------	--	--	--	--	--	------	-----	--	-----

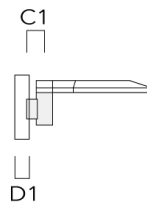

WE-EF LIGHTING (Thailand) Co., Ltd.

57 Moo 5, Kingkaew Rd., Bangplee, 10540 Samutprakarn - Phone: +66 2 738 96 20 - Fax: +66 2 738 96 29

<https://we-ef.com/asia>

Subject to technical changes and errors. - Generated on 23/11/2024

108-0954

PFL540 LED

we-ef

AKV

Description	Part ID	C1	D × L1	D × L2	H1	Weight (kg)
AKV2-76	300-0053	180	76x100	67x	235	1.50

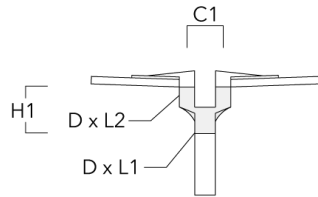

WE-EF LIGHTING (Thailand) Co., Ltd.

57 Moo 5, Kingkaew Rd., Bangplee, 10540 Samutprakarn - Phone: +66 2 738 96 20 - Fax: +66 2 738 96 29

<https://we-ef.com/asia>

Subject to technical changes and errors. - Generated on 23/11/2024

108-0954

PFL540 LED

we-ef

Control

R2C Ready to Connect

Description	Part ID
R2C Ready to Connect (top)	430-0019
R2C Ready to Connect (below)	430-0027
R2C Ready to Connect (top and below)	430-0032

WE-EF LIGHTING (Thailand) Co., Ltd.

57 Moo 5, Kingkaew Rd., Bangplee, 10540 Samutprakarn - Phone: +66 2 738 96 20 - Fax: +66 2 738 96 29

<https://we-ef.com/asia>

Subject to technical changes and errors. - Generated on 23/11/2024