

185-2689

ETC330-GB LED

we-ef



Description

IP67*, Class I. Class II on request. IK10+. Stainless steel construction including PCS hardware. Silicone rubber gasket. Safety glass lens; max. load 5 tonnes. Luminaire can be driven over at low speed. Factory-sealed termination chamber complete with cable gland and 1.5 m of flexible PVC free cable. Integral EC electronic converter in thermally separated compartment. 'No tool' removable gear/lens tray. CAD-optimised optics for superior illumination and glare control. OLC® One LED Concept. Factory installed LED circuit board. Gimbal mounted, 360° rotatable and 30° tiltable. Optional 2200 K version available. To be specified at time of ordering.

The optional installation blackout is recommended for mounting. To be ordered separately.

The luminaire is not suitable for permanent underwater operation and must be switched off in the event of flooding.

Optional with Anti-Slip ceramic Coating ASC to DIN 51130 (Trip Classification 10) available on request.

Weight	5.50 kg
Light distribution	symmetric, wide beam [B]
Light source	LED-12/12W / 350 mA - 4000 K
CRI	80
Power supply	EC
LEDs	12
Rated input power	13.9 W

Nominal Lumen (lm)

LED Lumen	170
Total Lumen	2040
Tj	85

Rated lumens (lm)

LED Lumen	128.5
Total Lumen	1542.3
Ta	25

Fagerhult Lighting Ltd

33-34 Dolben Street, SE1 0UQ London, United Kingdom

<https://we-ef.com/uk>

Subject to technical changes and errors. - Generated on 27/11/2024

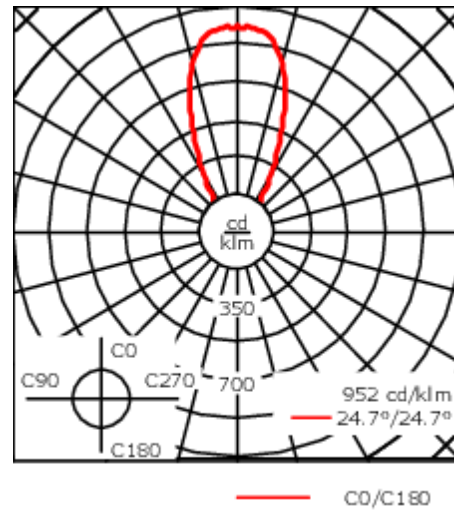
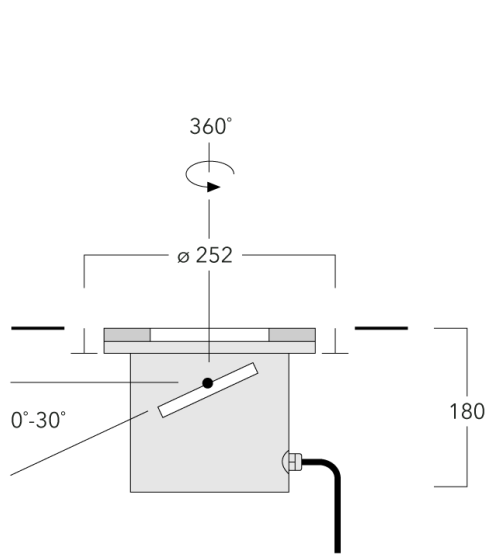

Specifications

Material description

Body	Stainless steel construction
Lens	Safety glass lens; max. load 5 tonnes
Colours	 Stainless Steel
Gasket	Silicone rubber gasket
Fasteners	PCS Polymer Coated Stainless Steel Hardware
Ingress protection	IP67
Impact resistance	IK10+

Electrical description

Power supply	220-240V / 50-60 Hz
Driver / Ballast	Integral EC electronic converter
Power factor	> 0.9
Surge protection	1/2 kV

Additional information

Lifetime	Ta=25° L90B10 > 90000h
Energy efficiency class	C-D (Light source)

Mounting Accessories

Installation cover

Description	Part ID	C1
Installation cover BE	185-0325	250

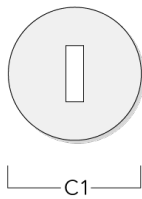

Installation blackout

Description	Part ID	D1	D2	H1	Weight (kg)	D	H
Blockout, Plastic	185-0924	250	305	230	1.50	250/305	230

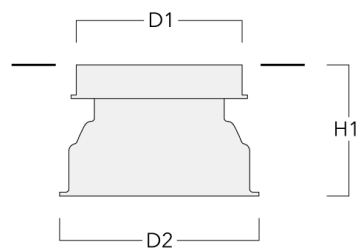

185-2689

ETC330-GB LED

we-ef

Electrical Accessories

Sealable junction box

Description	Part ID	C1	M1	M2
Sealable junction box SJB130	185-1624	146	Ø 10	Ø 12 - 19

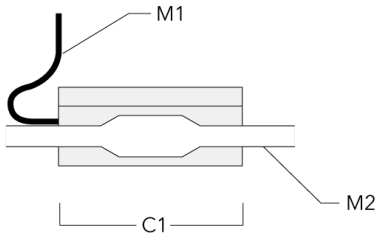

Optical Accessories**Linear spread lens**

Description	Part ID	C1
IO-180-ETC130/330-GB LED	185-2632	98

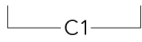
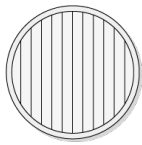
**Flood lens**

Description	Part ID	C1
IO-360-ETC130-GB-LED	185-2866	98

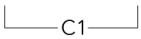
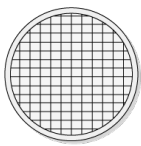

185-2689

ETC330-GB LED

we-ef

Honeycomb louvre

Description	Part ID	C1
IW-ETC130/330-GB-LED - [M][EE] [EES]	185-2870	98

