

185-2784

ETC110-3 LED

we-ef



Description

IP67. 12V - 24V AC/DC. Class III. IK09. Stainless steel construction. PCS hardware. Silicone CCG® Controlled Compression Gasket. Safety glass lens; max load 5.5 tons (11,000 lbs). Factory-sealed termination chamber complete with cable gland and 3 ft of flexible PVC-free cable. CAD-optimized optics for superior illumination and glare control. Driver required; to be ordered separately. Factory-installed LED circuit board.

Suitable for flush installation in concrete or earth. Deep concrete-pour installation blockout supplied as standard with luminaire.

IP68 in-line connector facilitates easy removal for off-site lamp replacement.

Specify product with 7 Digit product code - Finish Color. Accessories, such as mounting, optical, and electrical, must be specified separately.

Example: XXX-XXXX-9004 (Black)
+ XXX-XXXX (Accessory 1)

| | |
|--------------------|----------------------------------------------------|
| Weight | 3.00 lb |
| Light distribution | symmetric, very narrow beam, 'sharp cut-off' [VNS] |
| Light source | LED-3/3W / 24V AC/DC - 4000 K |
| CRI | 80 |
| LEDs | 3 |
| Rated input power | 3.8 W |

Nominal Lumen (lm)

| | |
|-------------|-----|
| LED Lumen | 170 |
| Total Lumen | 510 |
| Tj | 85 |

Rated lumens (lm)

| | |
|-------------|-------|
| LED Lumen | 132.1 |
| Total Lumen | 396.2 |
| Ta | 25 |

WE-EF LIGHTING USA, LLC

410-D Keystone Drive, 15086 Warrendale, PA 15086 - Phone: +1 724 742 0030
customersupport.usa@we-ef.com - <https://we-ef.com/us>
Subject to technical changes and errors. - Generated on 11/23/2024

185-2784

ETC110-3 LED

we-ef

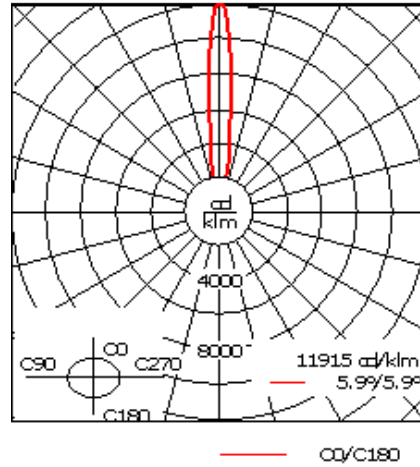
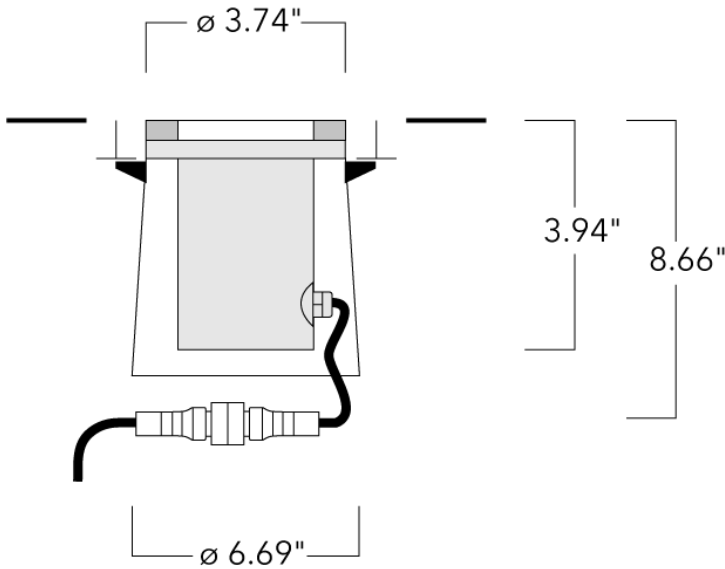

Specifications

Material description

| | |
|----------------------|-----------------------------------------------------------------------------------------------------|
| Body | Luminaire body constructed of stainless steel. Outer housing composite material. |
| Lens | Clear tempered glass lens. Max. load 5 tonnes. |
| Colors |  Stainless Steel |
| Gasket | Silicone rubber gasket |
| Fasteners | PCS polymer coated stainless steel |
| Ingress protection | IP67 |
| Impact resistance | IK09 |
| Corrosion resistance | 5CE |

WE-EF LIGHTING USA, LLC

410-D Keystone Drive, 15086 Warrendale, PA 15086 - Phone: +1 724 742 0030

customersupport.usa@we-ef.com - <https://we-ef.com/us>

Subject to technical changes and errors. - Generated on 11/23/2024

185-2784

we-ef

ETC110-3 LED

Electrical description

| | |
|------------------|--------------------------------------------------------------------------------------------|
| Power supply | Requires remote [RT] mounted 120-12 volt AC Class 2 power supply, to be ordered separately |
| Driver / Ballast | N/A |
| Termination | Factory sealed termination chamber |

Additional information

| | |
|----------|------------------------------------------------------------|
| Lifetime | Ta=25°/40° L90B10 > 90000h |
| Listings | ETL, UL-1598, CSA-C22.2#250.0. Suitable for Wet Locations. |

WE-EF LIGHTING USA, LLC

410-D Keystone Drive, 15086 Warrendale, PA 15086 - Phone: +1 724 742 0030
customersupport.usa@we-ef.com - <https://we-ef.com/us>
Subject to technical changes and errors. - Generated on 11/23/2024

185-2784

we-ef

ETC110-3 LED

Mounting Accessories

Installation blackout

| Description | Part ID | D1 | D2 | H1 | Weight (lb) | D | H |
|-------------------|----------|------|------|------|-------------|--------|-----|
| Blockout, Plastic | 185-0412 | 3.74 | 9.45 | 4.33 | 1.1 | 95/240 | 110 |

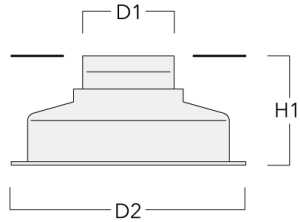

WE-EF LIGHTING USA, LLC

410-D Keystone Drive, 15086 Warrendale, PA 15086 - Phone: +1 724 742 0030
customersupport.usa@we-ef.com - <https://we-ef.com/us>

Subject to technical changes and errors. - Generated on 11/23/2024

185-2784

ETC110-3 LED

we-ef

Optical Accessories

Linear spread lens

| Description | Part ID | C1 |
|---------------------------|----------|------|
| Linear spread lens IO-180 | 185-0895 | 1.93 |

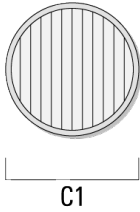

WE-EF LIGHTING USA, LLC

410-D Keystone Drive, 15086 Warrendale, PA 15086 - Phone: +1 724 742 0030
customersupport.usa@we-ef.com - <https://we-ef.com/us>

Subject to technical changes and errors. - Generated on 11/23/2024

185-2784

ETC110-3 LED

we-ef

Softening Lens

| Description | Part ID | C1 |
|-------------------|----------|------|
| Flood lens IO-360 | 185-0899 | 1.93 |

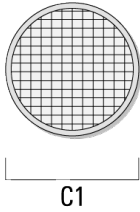

WE-EF LIGHTING USA, LLC

410-D Keystone Drive, 15086 Warrendale, PA 15086 - Phone: +1 724 742 0030
customersupport.usa@we-ef.com - <https://we-ef.com/us>
Subject to technical changes and errors. - Generated on 11/23/2024

185-2784

ETC110-3 LED

we-ef

Electrical Accessories

Sealable junction box

| Description | Part ID | C1 | M1 | M2 |
|-------------------------------|----------|------|--------|---------------|
| Sealable junction box SJB 130 | 185-1624 | 5.75 | Ø 0.39 | Ø 0.47 - 0.75 |

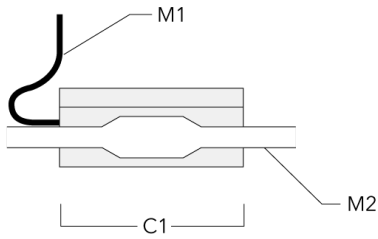

Transformers

| Description | Part ID |
|-------------------------------------|----------|
| Transformer 120 V - 12 V AC 24.0 W | 185-6904 |
| Transformer 120 V - 12 V AC 96.0 W | 185-6905 |
| Transformer 120 V - 12 V AC 240.0 W | 185-6906 |

WE-EF LIGHTING USA, LLC

410-D Keystone Drive, 15086 Warrendale, PA 15086 - Phone: +1 724 742 0030

customersupport.usa@we-ef.com - <https://we-ef.com/us>

Subject to technical changes and errors. - Generated on 11/23/2024