



Description

IP66, Class I. IK08. Marine-grade, die-cast aluminium alloy. 5CE superior corrosion protection including PCS hardware. RFC™ Reflection Free Contour main lens. Silicone CCG® Controlled Compression Gasket. Luminaire is factory-sealed and does not need to be opened during installation.

Integral electronic converter with DALI interface. Advanced thermal management protects LEDs while optimising lumens output. Removable LED boards for upgrading. CAD-optimised optics for superior illumination and glare control. OLC® One LED Concept.

Variant with 2200 K or as 'Wild-Light' 2200 K combined with 3000 K with Eco Step Dim® Advanced or Motion available on request, must be specified at time of ordering.

Contact WE-EF direct or your local WE-EF sales representative for an individual solution designed to precisely meet your needs.

Including 0.5 m cable with a cable connector.

Maximum spacing for streetlighting applications depends on wattage and light distribution: 5.5 to 9 times the mounting height.

| | |
|--------------------|------------------------------|
| Weight | 8.20 kg |
| Light distribution | asymmetric, side throw [S65] |
| Light source | LED-42/84W / 700 mA - 4000 K |
| CRI | 80 |
| Power supply | EC |
| BUG | B2 U0 G2 |
| LEDs | 42 |
| Rated input power | 96 W |

Nominal Lumen (lm)

| | |
|-------------|-------|
| LED Lumen | 310 |
| Total Lumen | 13020 |
| Tj | 85 |

Rated lumens (lm)

| | |
|-------------|---------|
| LED Lumen | 281.8 |
| Total Lumen | 11836.5 |
| Ta | 25 |

WE-EF LIGHTING (Thailand) Co., Ltd.

57 Moo 5, Kingkaew Rd., Bangplee, 10540 Samutprakarn - Phone: +66 2 738 96 20 - Fax: +66 2 738 96 29

<https://we-ef.com/asia>

Subject to technical changes and errors. - Generated on 23/10/2024

108-0972

VFL540 LED

we-ef

Wild-Light options available on request.

WE-EF LIGHTING (Thailand) Co., Ltd.

57 Moo 5, Kingkaew Rd., Bangplee, 10540 Samutprakarn - Phone: +66 2 738 96 20 - Fax: +66 2 738 96 29

<https://we-ef.com/asia>

Subject to technical changes and errors. - Generated on 23/10/2024

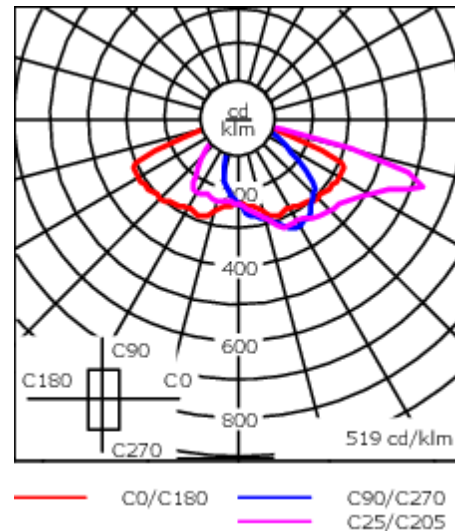
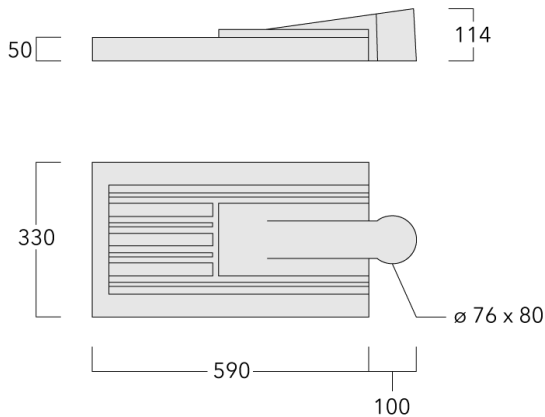

Specifications

Material description

| | |
|----------------------|--|
| Body | Marine-grade, die-cast aluminium alloy |
| Lens | RFC™ Reflection Free Contour main lens |
| Colours | <div style="display: flex; align-items: center;"> <div style="width: 20px; height: 10px; background-color: black; margin-right: 5px;"></div> <div>RAL9004 Signal black</div> </div> <div style="display: flex; align-items: center; margin-top: 5px;"> <div style="width: 20px; height: 10px; background-color: grey; margin-right: 5px;"></div> <div>RAL9007 Grey aluminium</div> </div> <div style="display: flex; align-items: center; margin-top: 5px;"> <div style="width: 20px; height: 10px; background-color: darkgrey; margin-right: 5px;"></div> <div>RAL7016 Anthracite grey</div> </div> <div style="display: flex; align-items: center; margin-top: 5px;"> <div style="width: 20px; height: 10px; background-color: white; margin-right: 5px;"></div> <div>RAL9016 Traffic white</div> </div> |
| Gasket | Silicone CCG® Controlled Compression Gasket |
| Fasteners | PCS Polymer Coated Stainless Steel Hardware |
| Ingress protection | IP66 |
| Impact resistance | IK08 |
| Corrosion resistance | 5CE |
| Windage | 0.146 m ² |

Electrical description

| | |
|------------------|---|
| Power supply | 220-240V / 50-60 Hz |
| Driver / Ballast | Integral electronic converter with DALI interface |
| Power factor | > 0.9 |

Additional information

| | |
|------------|--|
| Lifetime | T _a =25° L90B10 > 90000h |
| BUG Rating | Please see individual Spec Sheets for classification of Backlight, Uplight and Glare |

WE-EF LIGHTING (Thailand) Co., Ltd.

57 Moo 5, Kingkaew Rd., Bangplee, 10540 Samutprakarn - Phone: +66 2 738 96 20 - Fax: +66 2 738 96 29

<https://we-ef.com/asia>

Subject to technical changes and errors. - Generated on 23/10/2024

Mounting Accessories

Wall and pole brackets RV

| Description | Part ID | Additional information | C1 | C2 | C3 | D1 | D × L1 | H1 | H2 | M1 | M2 | Weight (kg) | C | D | H |
|------------------|-------------|------------------------|-----|-----|----|----|--------|-----|-----|----|----|-------------|-----|---|---|
| RV0 Wall bracket | 108-0979-AP | RV0 Wall bracket | 108 | 100 | 45 | | | 200 | 160 | 40 | 12 | 2.80 | 108 | | |

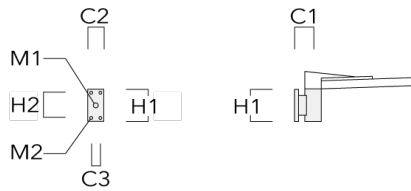

| | | | | | | | | | | | | | | | |
|-----------------------------|----------|--|-----|--|--|--|----------|--|--|--|--|------|-----|----|-----|
| RV2-76 Pole bracket, double | 108-0980 | | 147 | | | | 76 x 100 | | | | | 8.10 | 147 | 76 | 200 |
|-----------------------------|----------|--|-----|--|--|--|----------|--|--|--|--|------|-----|----|-----|

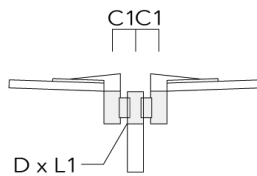

VFL540 LED

| Description | Part ID | Additional information | C1 | C2 | C3 | D1 | D × L1 | H1 | H2 | M1 | M2 | Weight (kg) | C | D | H |
|-----------------------------|----------|------------------------|----|----|----|----|----------|----|----|----|----|-------------|-----|----|-----|
| RV2-60 Pole bracket, double | 108-0981 | 147 | | | | | 60 x 100 | | | | | 8.50 | 147 | 60 | 200 |

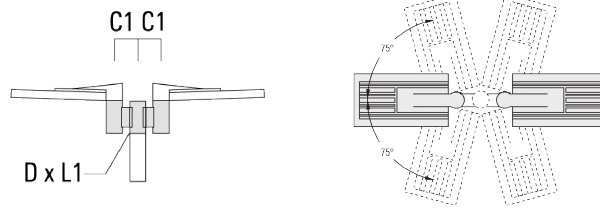

| | | | | | | | | | | | | | | |
|------------------|----------|-----|--|--|--|--------|--|--|--|--|--|------|-----|-----|
| RV5 Pole bracket | 108-0982 | 108 | | | | 76-240 | | | | | | 2.30 | 106 | 200 |
|------------------|----------|-----|--|--|--|--------|--|--|--|--|--|------|-----|-----|

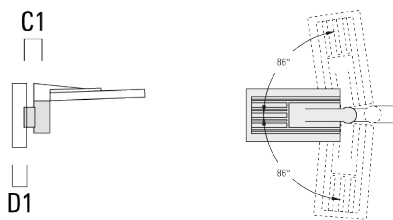

AKV

108-0972

VFL540 LED

we-ef

| Description | Part ID | C1 | D × L1 | D × L2 | H1 | Weight (kg) |
|-------------|----------|-----|--------|--------|-----|-------------|
| AKV2-76 | 300-0053 | 180 | 76x100 | 76x80 | 235 | 1.50 |

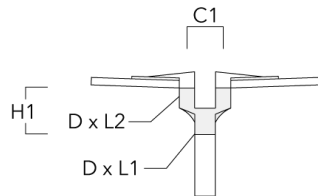

WE-EF LIGHTING (Thailand) Co., Ltd.

57 Moo 5, Kingkaew Rd., Bangplee, 10540 Samutprakarn - Phone: +66 2 738 96 20 - Fax: +66 2 738 96 29

<https://we-ef.com/asia>

Subject to technical changes and errors. - Generated on 23/10/2024

108-0972

VFL540 LED

we-ef

Control

R2C Ready to Connect

| Description | Part ID |
|--------------------------------------|----------|
| R2C Ready to Connect (top) | 430-0019 |
| R2C Ready to Connect (below) | 430-0027 |
| R2C Ready to Connect (top and below) | 430-0032 |

WE-EF LIGHTING (Thailand) Co., Ltd.

57 Moo 5, Kingkaew Rd., Bangplee, 10540 Samutprakarn - Phone: +66 2 738 96 20 - Fax: +66 2 738 96 29

<https://we-ef.com/asia>

Subject to technical changes and errors. - Generated on 23/10/2024

108-0972

VFL540 LED

WE-EF LIGHTING (Thailand) Co., Ltd.

57 Moo 5, Kingkaew Rd., Bangplee, 10540 Samutprakarn

Phone: +66 2 738 96 20

Fax: +66 2 738 96 29

<https://we-ef.com/asia>

Subject to technical changes and errors.

Generated on 23/10/2024

we-ef

A Fagerhult Group Company