



Description

IP69. IK10+. Stainless steel construction including PCS hardware. Safety glass lens, max. load 5 tonnes. Luminaire can be driven over at low speed. Silicone rubber gasket. Anti-wick technology, equipped with a cable gland and 1.5 meters of flexible, PVC-free cable.

Integral EC electronic converter. Advanced thermal management protects LEDs while optimising lumens output. Removable LED boards for upgrading. CAD-optimised optics for superior illumination and glare control. OLC® One LED Concept. 20° tiltable and 355° rotatable. 1-10 V analogue dimming or DALI interface available on request.

Luminaire installation blockout and sealable junction box included in supply.

Weight	3.90 kg
Light distribution	flood, very narrow beam [EE]
Light source	LED-3/6W / 700 mA - 3000 K
CRI	80
Power supply	EC
LEDs	3
Rated input power	7.5 W

Nominal Lumen (lm)

LED Lumen	290
Total Lumen	870
Tj	85

Rated lumens (lm)

LED Lumen	201.8
Total Lumen	605.3
Ta	25

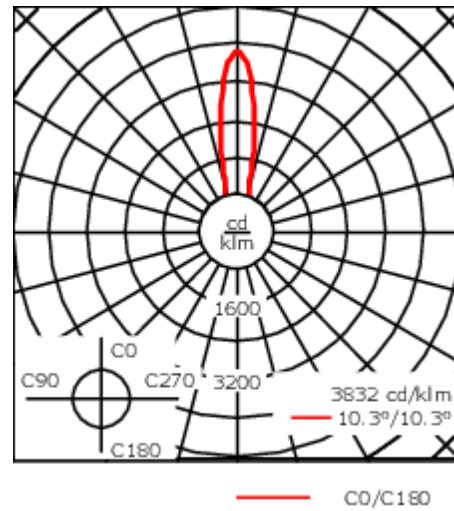
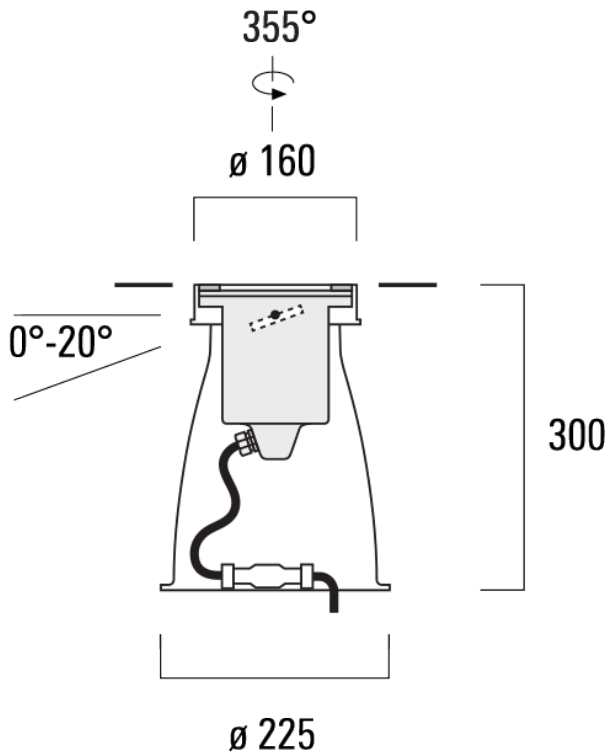

Specifications

Material description

Body	Stainless steel construction
Lens	Safety glass lens, max. load 5 tonnes
Colours	 Stainless Steel
Gasket	Silicone rubber gasket
Fasteners	PCS hardware
Ingress protection	IP69
Impact resistance	IK10+

Electrical description

Driver / Ballast	Integral EC electronic converter
------------------	----------------------------------

Additional information

WE-EF LIGHTING (Thailand) Co., Ltd.

57 Moo 5, Kingkaew Rd., Bangplee, 10540 Samutprakarn - Phone: +66 2 738 96 20 - Fax: +66 2 738 96 29

<https://we-ef.com/asia>

Subject to technical changes and errors. - Generated on 23/11/2024

185-7593+185-9613

ETC120-GB LED

we-ef

Control

DALI interface

Description	Part ID
DALI	430-0013

1-10 V analogue dimming interface

Description	Part ID
1-10 V analogue dimming interface	430-0011

WE-EF LIGHTING (Thailand) Co., Ltd.

57 Moo 5, Kingkaew Rd., Bangplee, 10540 Samutprakarn - Phone: +66 2 738 96 20 - Fax: +66 2 738 96 29

<https://we-ef.com/asia>

Subject to technical changes and errors. - Generated on 23/11/2024

185-7593+185-9613

ETC120-GB LED

we-ef

Mounting Accessories

Installation cover

Description	Part ID	C1
Installation cover BE	185-0796	160

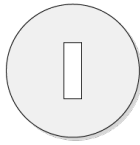

C1

WE-EF LIGHTING (Thailand) Co., Ltd.

57 Moo 5, Kingkaew Rd., Bangplee, 10540 Samutprakarn - Phone: +66 2 738 96 20 - Fax: +66 2 738 96 29

<https://we-ef.com/asia>

Subject to technical changes and errors. - Generated on 23/11/2024

Optical Accessories

Honeycomb louvre

Description	Part ID	C1
Honeycomb louvre IW	185-2869	60

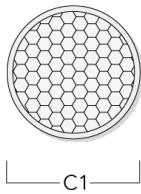

Linear spread lens

Description	Part ID	C1
Linear spread lens IO-180	185-9612	60

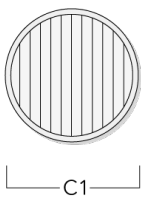

ETC120-GB LED

Flood lens

Description	Part ID	C1
Flood lens IO-360	185-9613	60

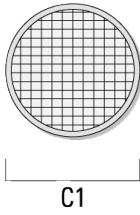

Linear louvre

Description	Part ID	Additional information	C1
Linear louvre IL	185-9614	ETC320	60



ETC120-GB LED

Colour filter

Description	Part ID
Colour filter IF	on request

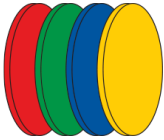

Colour correction filter

Description	Part ID
IF-3000K > 2400K	185-9973

