



Description

IP69. IK10+. Stainless steel construction including PCS hardware. Safety glass lens, max. load 5 tonnes. Luminaire can be driven over at low speed. Silicone rubber gasket. Anti-wick technology, equipped with a cable gland and 1.5 meters of flexible, PVC-free cable.

Integral EC electronic converter. Advanced thermal management protects LEDs while optimising lumens output. Removable LED boards for upgrading. CAD-optimised optics for superior illumination and glare control. OLC® One LED Concept. 20° tiltable and 355° rotatable. 1-10 V analogue dimming or DALI interface available on request.

Luminaire installation blockout and sealable junction box included in supply.

Weight	3.70 kg
Light distribution	symmetric, very narrow beam, sharp cut-off [EES]
Light source	LED-3/6W / 700 mA - 3000 K
CRI	80
Power supply	EC
LEDs	3
Rated input power	7.5 W
Nominal Lumen (lm)	
LED Lumen	290
Total Lumen	870
T _j	85
Rated lumens (lm)	
LED Lumen	233.6
Total Lumen	700.7
T _a	25

185-7682

ETC120-GB LED

we-ef

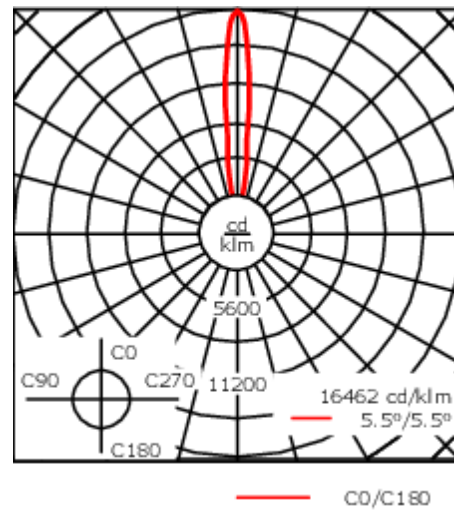
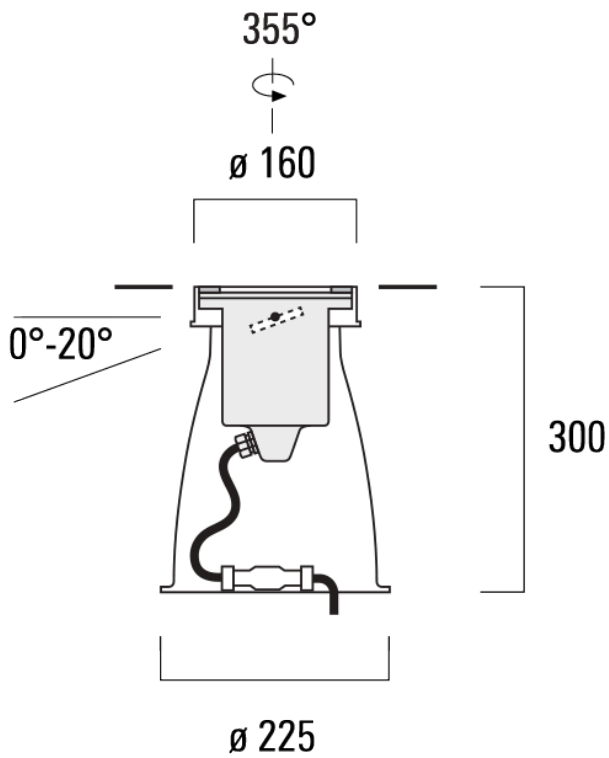

Specifications

Material description

Body	Stainless steel construction
Lens	Safety glass lens, max. load 5 tonnes
Colours	 Stainless Steel
Gasket	Silicone rubber gasket
Fasteners	PCS hardware
Ingress protection	IP69
Impact resistance	IK10+

Electrical description

Driver / Ballast	Integral EC electronic converter
------------------	----------------------------------

Additional information

WE-EF LIGHTING (Thailand) Co., Ltd.

57 Moo 5, Kingkaew Rd., Bangplee, 10540 Samutprakarn - Phone: +66 2 738 96 20 - Fax: +66 2 738 96 29

<https://we-ef.com/asia>

Subject to technical changes and errors. - Generated on 23/11/2024

185-7682

ETC120-GB LED

we-ef

Control

DALI interface

Description	Part ID
DALI	430-0013

1-10 V analogue dimming interface

Description	Part ID
1-10 V analogue dimming interface	430-0011

WE-EF LIGHTING (Thailand) Co., Ltd.

57 Moo 5, Kingkaew Rd., Bangplee, 10540 Samutprakarn - Phone: +66 2 738 96 20 - Fax: +66 2 738 96 29

<https://we-ef.com/asia>

Subject to technical changes and errors. - Generated on 23/11/2024

185-7682

ETC120-GB LED

we-ef

Mounting Accessories

Installation cover

Description	Part ID	C1
Installation cover BE	185-0796	160



C1

WE-EF LIGHTING (Thailand) Co., Ltd.

57 Moo 5, Kingkaew Rd., Bangplee, 10540 Samutprakarn - Phone: +66 2 738 96 20 - Fax: +66 2 738 96 29

<https://we-ef.com/asia>

Subject to technical changes and errors. - Generated on 23/11/2024

185-7682

ETC120-GB LED

we-ef

Optical Accessories

Honeycomb louvre

Description	Part ID	C1
Honeycomb louvre IW	185-2869	60

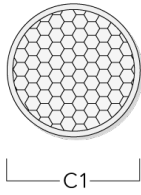

Linear spread lens

Description	Part ID	C1
Linear spread lens IO-180	185-9612	60

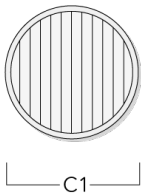

WE-EF LIGHTING (Thailand) Co., Ltd.

57 Moo 5, Kingkaew Rd., Bangplee, 10540 Samutprakarn - Phone: +66 2 738 96 20 - Fax: +66 2 738 96 29

<https://we-ef.com/asia>

Subject to technical changes and errors. - Generated on 23/11/2024

Flood lens

Description	Part ID	C1
Flood lens IO-360	185-9613	60

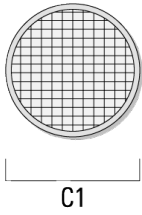

Linear louvre

Description	Part ID	Additional information	C1
Linear louvre IL	185-9614	ETC320	60



185-7682

ETC120-GB LED

we-ef

Colour filter

Description	Part ID
Colour filter IF	on request

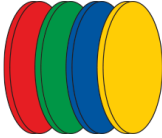

Colour correction filter

Description	Part ID
IF-3000K > 2400K	185-9973

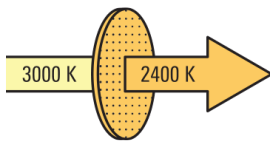

WE-EF LIGHTING (Thailand) Co., Ltd.

57 Moo 5, Kingkaew Rd., Bangplee, 10540 Samutprakarn - Phone: +66 2 738 96 20 - Fax: +66 2 738 96 29

<https://we-ef.com/asia>

Subject to technical changes and errors. - Generated on 23/11/2024