

195-9527

DLS229 LED

we-ef



Description

IP55, Class I. Class II on request. IK10. Marine-grade, die-cast aluminium alloy. 5CE superior corrosion protection including PCS hardware. Silicone rubber gasket. Polycarbonate main lens. Two cable entries. Factory installed LED circuit board. Integral EC electronic converter.

Weight	2.20 kg
Light distribution	diffused distribution
Light source	LED-FT-17W / 500 mA - 3000 K
CRI	80
Power supply	EC
LEDs	1
Rated input power	20 W
Rated lumens (lm)	
LED Lumen	974.4
Total Lumen	974.4
Ta	25
Nominal Lumen (lm)	
LED Lumen	3070
Total Lumen	3070
Tc	25

WE-EF LEUCHTEN GmbH

Töpinger Straße 16, 29646 Bispingen, Germany - Phone: +49 5194 909-0
info@we-ef.com - <https://we-ef.com>

Subject to technical changes and errors. - Generated on 23/11/2024

195-9527

DLS229 LED



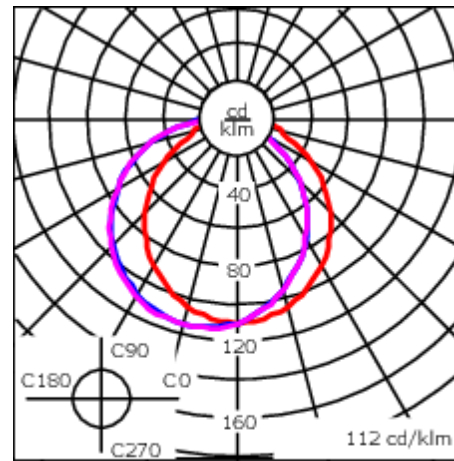
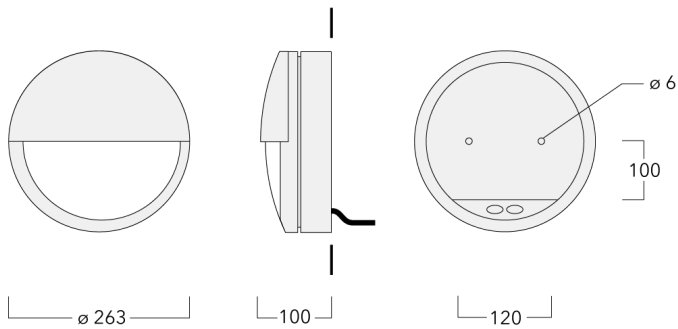

we-ef



— C0/C180 — C90/C270
— C85/C265

Specifications

Material description

Body	Marine-grade die-cast aluminium alloy
Lens	Polycarbonate main lens
Colours	 RAL9004 Signal black  RAL9006 White aluminium  RAL9007 Grey aluminium  RAL7016 Anthracite grey  RAL9016 Traffic white
Gasket	Silicone rubber gasket
Fasteners	PCS Polymer Coated Stainless Steel Hardware
Ingress protection	IP55
Impact resistance	IK10
Corrosion resistance	5CE

Electrical description

Power supply	220-240V / 50-60 Hz
Driver / Ballast	Integral EC electronic converter
Surge protection	1/2 kV

Additional information

Lifetime	Ta=25° L70B50 > 50000h
----------	------------------------

WE-EF LEUCHTEN GmbH

Töpinger Straße 16, 29646 Bispingen, Germany - Phone: +49 5194 909-0
info@we-ef.com - <https://we-ef.com>

Subject to technical changes and errors. - Generated on 23/11/2024