

195-9528

DLS229 LED

we-ef



Description

IP55, Class I. IK10. Marine-grade, die-cast aluminium alloy. 5CE superior corrosion protection including PCS hardware. Polycarbonate lens. Silicone rubber gasket. Two cable entries.

Integral EC electronic converter. Advanced thermal management protects LEDs while optimising lumens output.

Weight	2.10 kg
Light distribution	diffused distribution
Light source	LED-FT-17W / 500 mA - 4000 K
CRI	80
Power supply	EC
LEDs	1
Rated input power	20 W
Rated lumens (lm)	
LED Lumen	1015.7
Total Lumen	1015.7
Ta	25
Nominal Lumen (lm)	
LED Lumen	3200
Total Lumen	3200
Tc	25

WE-EF LIGHTING (Thailand) Co., Ltd.

57 Moo 5, Kingkaew Rd., Bangplee, 10540 Samutprakarn - Phone: +66 2 738 96 20 - Fax: +66 2 738 96 29

<https://we-ef.com/asia>

Subject to technical changes and errors. - Generated on 23/11/2024

195-9528



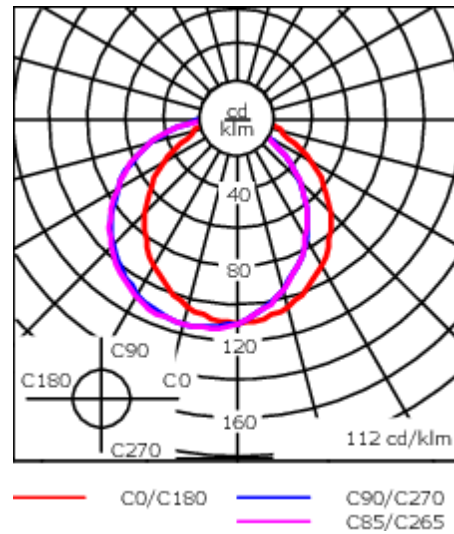
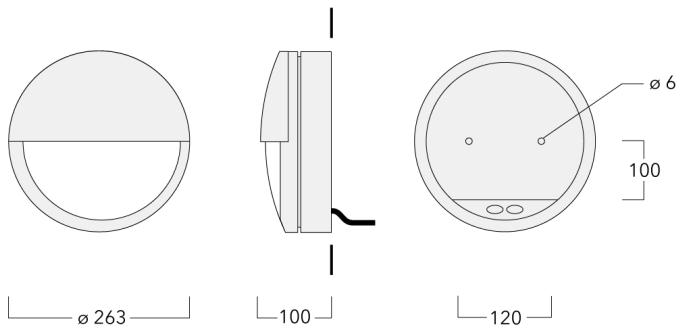

DLS229 LED

we-ef



Specifications

Material description

Body	Marine-grade, die-cast aluminium alloy
Lens	Polycarbonate lens
Colours	 RAL9004 Signal black  RAL9007 Grey aluminium  RAL7016 Anthracite grey  RAL9016 Traffic white
Gasket	Silicone rubber gasket
Fasteners	PCS hardware
Ingress protection	IP55
Impact resistance	IK10
Corrosion resistance	5CE

Electrical description

Power supply	220-240V / 50-60 Hz
Driver / Ballast	Integral EC electronic converter

Additional information

Lifetime	Ta=25° L70B50 > 50000h
----------	------------------------

WE-EF LIGHTING (Thailand) Co., Ltd.

57 Moo 5, Kingkaew Rd., Bangplee, 10540 Samutprakarn - Phone: +66 2 738 96 20 - Fax: +66 2 738 96 29

<https://we-ef.com/asia>

Subject to technical changes and errors. - Generated on 23/11/2024