

195-9542

DLS239 LED

**we-ef**



### Description

AnBetreffGesendetGrößeKategorien

Dennis JacobiAW: AW:13:2580 KB

Weight	3.70 kg
Light distribution	diffused distribution
Light source	LED-FT-28W / 800 mA - 3000 K
CRI	80
Power supply	EC
LEDs	1
Rated input power	31 W
<b>Rated lumens (lm)</b>	
LED Lumen	1198.1
Total Lumen	1198.1
Ta	25
<b>Nominal Lumen (lm)</b>	
LED Lumen	4760
Total Lumen	4760
Tc	25

### Fagerhult Lighting Ltd

33-34 Dolben Street, SE1 0UQ London, United Kingdom

<https://we-ef.com/uk>

Subject to technical changes and errors. - Generated on 23/11/2024

195-9542



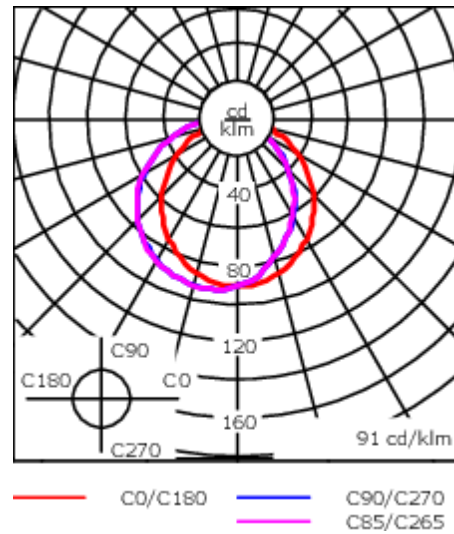
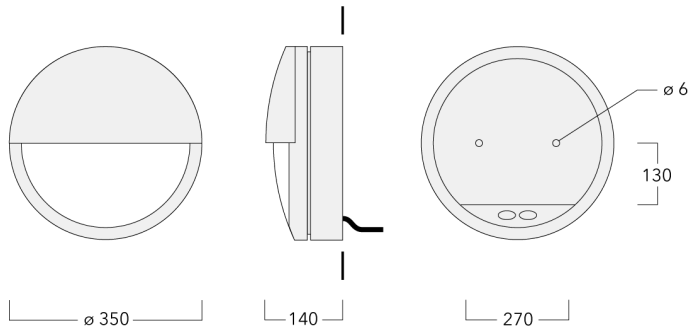

DLS239 LED

**we-ef**



## Specifications

### Material description

Body	Marine-grade die-cast aluminium alloy
Lens	Polycarbonate main lens
Colours	 RAL9004 Signal black  RAL9006 White aluminium  RAL9007 Grey aluminium  RAL7016 Anthracite grey  RAL9016 Traffic white
Gasket	Silicone rubber gasket
Fasteners	PCS Polymer Coated Stainless Steel Hardware
Ingress protection	IP55
Impact resistance	IK10
Corrosion resistance	5CE

### Electrical description

Power supply	220-240V / 50-60 Hz
Driver / Ballast	Integral EC electronic converter
Surge protection	1/2 kV

### Additional information

Lifetime	Ta=25° L70B50 > 50000h
Energy efficiency class	D-E (Light source)

#### Fagerhult Lighting Ltd

33-34 Dolben Street, SE1 0UQ London, United Kingdom

<https://we-ef.com/uk>

Subject to technical changes and errors. - Generated on 23/11/2024