

195-9543

DLS239 LED

**we-ef**



### Description

AnBetreffGesendetGrößeKategorien  
Dennis JacobiAW: AW:13:2580 KB

|                           |                              |
|---------------------------|------------------------------|
| Weight                    | 3.70 kg                      |
| Light distribution        | diffused distribution        |
| Light source              | LED-FT-28W / 800 mA - 4000 K |
| CRI                       | 80                           |
| Power supply              | EC                           |
| LEDs                      | 1                            |
| Rated input power         | 31 W                         |
| <b>Rated lumens (lm)</b>  |                              |
| LED Lumen                 | 1250.9                       |
| Total Lumen               | 1250.9                       |
| Ta                        | 25                           |
| <b>Nominal Lumen (lm)</b> |                              |
| LED Lumen                 | 4970                         |
| Total Lumen               | 4970                         |
| Tc                        | 25                           |

### Fagerhult Lighting Ltd

33-34 Dolben Street, SE1 0UQ London, United Kingdom

<https://we-ef.com/uk>

Subject to technical changes and errors. - Generated on 23/11/2024

195-9543



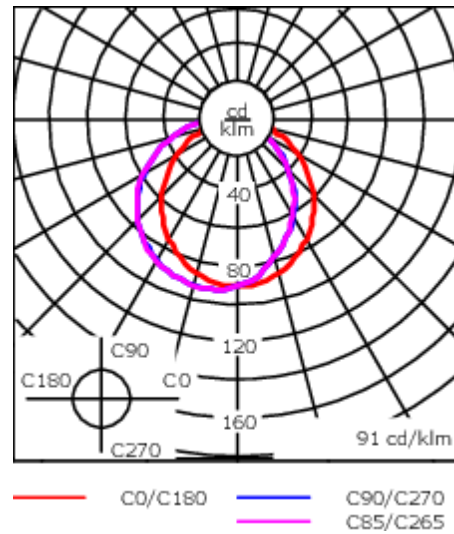
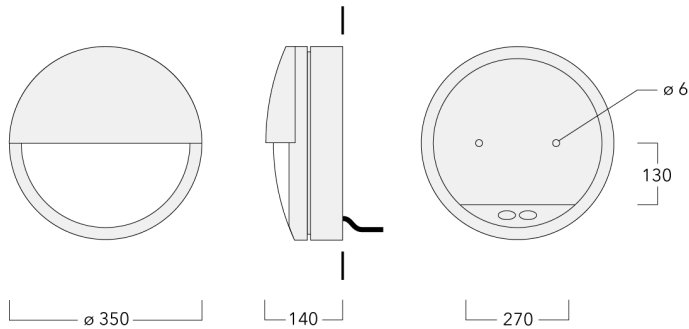

DLS239 LED

**we-ef**



## Specifications

### Material description

|                      |   |
|----------------------|---|
| Body                 | Marine-grade die-cast aluminium alloy   |
| Lens                 | Polycarbonate main lens   |
| Colours              |  RAL9004 Signal black<br> RAL9006 White aluminium<br> RAL9007 Grey aluminium<br> RAL7016 Anthracite grey<br> RAL9016 Traffic white |
| Gasket               | Silicone rubber gasket  |
| Fasteners            | PCS Polymer Coated Stainless Steel Hardware   |
| Ingress protection   | IP55  |
| Impact resistance    | IK10  |
| Corrosion resistance | 5CE   |

### Electrical description

|                  |                                  |
|------------------|----------------------------------|
| Power supply     | 220-240V / 50-60 Hz              |
| Driver / Ballast | Integral EC electronic converter |
| Surge protection | 1/2 kV                           |

### Additional information

|                         |                        |
|-------------------------|------------------------|
| Lifetime                | Ta=25° L70B50 > 50000h |
| Energy efficiency class | D-E (Light source)     |

#### Fagerhult Lighting Ltd

33-34 Dolben Street, SE1 0UQ London, United Kingdom

<https://we-ef.com/uk>

Subject to technical changes and errors. - Generated on 23/11/2024