



Description

IP66, Class I. IK08. Marine-grade die-cast aluminium alloy. 5CE superior corrosion protection including PCS hardware. RFC™ Reflection Free Contour main lens. Silicone CCG® Controlled Compression Gasket. Luminaire is factory-sealed and does not need to be opened during installation.

Integral electronic converter with DALI interface. Advanced thermal management protects LEDs while optimising lumens output. Removable LED boards for upgrading. CAD-optimised optics for superior illumination and glare control. OLC® One LED Concept.

Variant with 2200 K or as 'Wild-Light' 2200 K combined with 3000 K with Eco Step Dim® Advanced or Motion available on request, must be specified at time of ordering.

Contact WE-EF direct or your local WE-EF sales representative for an individual solution designed to precisely meet your needs.

Including 0.5 m cable with a cable connector.

Maximum spacing for streetlighting applications depends on wattage and light distribution: 5.5 to 9 times the mounting height.

Weight	8.20 kg
Light distribution	rectangular, side throw [R65]
Light source	LED-36/72W / 700 mA - 4000 K
CRI	80
Power supply	EC
BUG	B2 U0 G2
LEDs	36
Rated input power	79 W

Nominal Lumen (lm)

LED Lumen	310
Total Lumen	11160
Tj	85

Rated lumens (lm)

LED Lumen	264.5
Total Lumen	9520.3
Ta	25

WE-EF LIGHTING (Thailand) Co., Ltd.

57 Moo 5, Kingkaew Rd., Bangplee, 10540 Samutprakarn - Phone: +66 2 738 96 20 - Fax: +66 2 738 96 29

<https://we-ef.com/asia>

Subject to technical changes and errors. - Generated on 23/11/2024

108-1256

VFL540-SE LED

we-ef

Wild-Light options available on request.

WE-EF LIGHTING (Thailand) Co., Ltd.

57 Moo 5, Kingkaew Rd., Bangplee, 10540 Samutprakarn - Phone: +66 2 738 96 20 - Fax: +66 2 738 96 29

<https://we-ef.com/asia>

Subject to technical changes and errors. - Generated on 23/11/2024

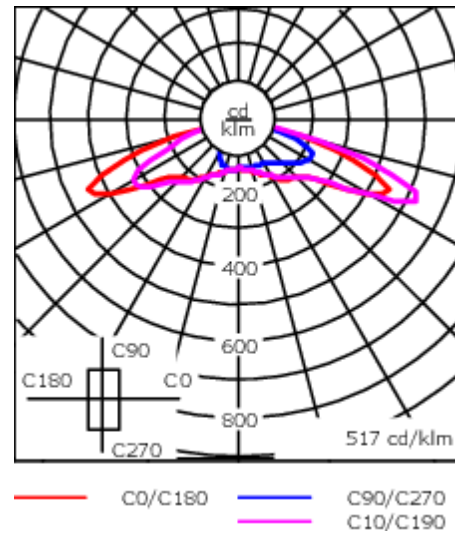
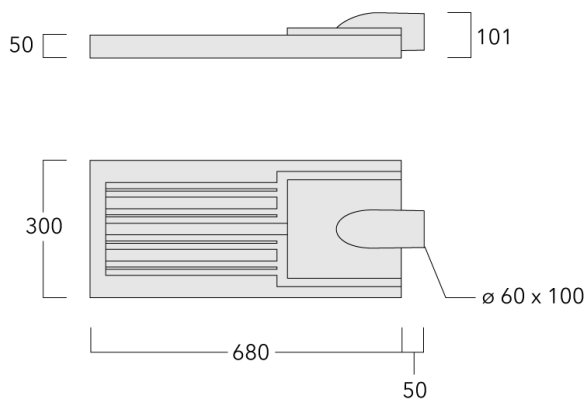

Specifications

Material description

Body	Marine-grade, die-cast aluminium alloy
Lens	RFC™ Reflection Free Contour main lens
Colours	<div style="display: flex; align-items: center; gap: 10px;"> <div style="width: 20px; height: 15px; background-color: black; margin-right: 5px;"></div> RAL9004 Signal black </div> <div style="display: flex; align-items: center; gap: 10px; margin-top: 5px;"> <div style="width: 20px; height: 15px; background-color: grey; margin-right: 5px;"></div> RAL9007 Grey aluminium </div> <div style="display: flex; align-items: center; gap: 10px; margin-top: 5px;"> <div style="width: 20px; height: 15px; background-color: darkgrey; margin-right: 5px;"></div> RAL7016 Anthracite grey </div> <div style="display: flex; align-items: center; gap: 10px; margin-top: 5px;"> <div style="width: 20px; height: 15px; background-color: lightgrey; margin-right: 5px;"></div> RAL9016 Traffic white </div>
Gasket	Silicone CCG® Controlled Compression Gasket
Fasteners	PCS Polymer Coated Stainless Steel Hardware
Ingress protection	IP66
Impact resistance	IK08
Corrosion resistance	5CE
Windage	0.208 m ²

Electrical description

Power supply	220-240V / 50-60 Hz
Driver / Ballast	Integral electronic converter with DALI interface
Power factor	> 0.9

Additional information

Lifetime	Ta=25° L90B10 > 90000h
BUG Rating	Please see individual Spec Sheets for classification of Backlight, Uplight and Glare

WE-EF LIGHTING (Thailand) Co., Ltd.

57 Moo 5, Kingkaew Rd., Bangplee, 10540 Samutprakarn - Phone: +66 2 738 96 20 - Fax: +66 2 738 96 29

<https://we-ef.com/asia>

Subject to technical changes and errors. - Generated on 23/11/2024

Mounting Accessories

Pole brackets RF

Description	Part ID	Additional information	C1	D × L1	H1	Weight (kg)	C	H
RF1-540 Pole bracket, single	111-0046		200	76 x 80	200	5.60	200	300

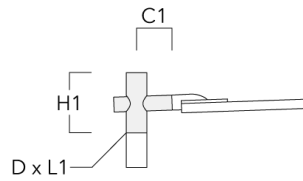

RF2-540 Pole bracket, double	111-0047		200	76 x 80	200	6.20	200	300
------------------------------	----------	--	-----	---------	-----	------	-----	-----

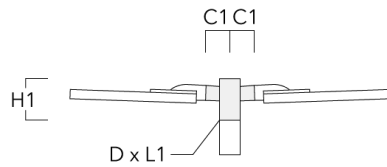

VFL540-SE LED

Description	Part ID	Additional information	C1	D × L1	H1	Weight (kg)	C	H
Pole bracket RF1, single for mounting on AMW poles	111-9010	Mounting brackets. Marine-grade aluminium alloy. 5CE superior corrosion protection including PCS hardware.	320	(102 x 80) + (76 x 100)	340	5.80		

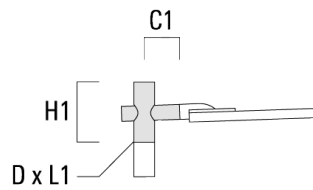

VFL540-SE LED

Description	Part ID	Additional information	C1	D × L1	H1	Weight (kg)	C	H
Pole bracket RF2, double for mounting on AMW poles	111-9011	Mounting brackets. Marine-grade aluminium alloy. 5CE superior corrosion protection including PCS hardware.	320	(102 x 80) + (76 x 100)	340	6.40		

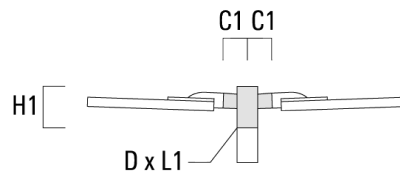

Wall and pole brackets RE

Description	Part ID	Additional information	C1	D1	D2	D × L1	H1	M1	Weight (kg)	C	H
Wall bracket RE0-540	111-0084		180	230	195			12	2.60	140	

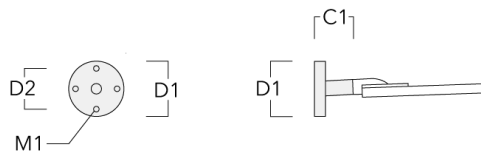

VFL540-SE LED

Description	Part ID	Additional information	C1	D1	D2	D × L1	H1	M1	Weight (kg)	C	H
Pole bracket RE1-540, single	111-0042		200			76 x 130	550		7.30	200	550

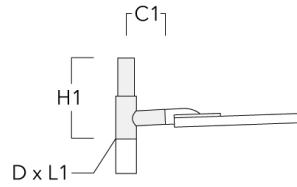

Pole bracket RE2-540, double	111-0043		200			76 x 130	550		8.40	200	550
------------------------------	----------	--	-----	--	--	----------	-----	--	------	-----	-----

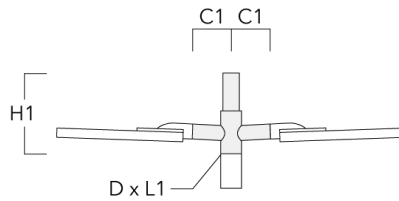

VFL540-SE LED

Description	Part ID	Additional information	C1	D1	D2	D × L1	H1	M1	Weight (kg)	C	H
Pole bracket RE1, single for mounting on AML-A poles	111-9022	Mounting brackets. Marine-grade aluminium alloy. 5CE superior corrosion protection including PCS hardware.	320			76 x 76	550		6.10		



VFL540-SE LED

Description	Part ID	Additional information	C1	D1	D2	D × L1	H1	M1	Weight (kg)	C	H
Pole bracket RE2, double for mounting on AML-A poles	111-9023	Mounting brackets. Marine-grade aluminium alloy. 5CE superior corrosion protection including PCS hardware.	320			76 x 76	550		7.20		

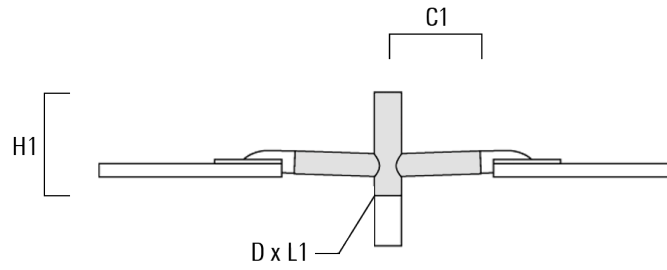

VFL540-SE LED

Description	Part ID	Additional information	C1	D1	D2	D × L1	H1	M1	Weight (kg)	C	H
Pole bracket RE1, single for mounting on AMW poles	111-9012	Mounting brackets. Marine-grade aluminium alloy. 5CE superior corrosion protection including PCS hardware.	320			(102 x 80) + (76 x 100)	590		7.50		



VFL540-SE LED

Description	Part ID	Additional information	C1	D1	D2	D × L1	H1	M1	Weight (kg)	C	H
Pole bracket RE2, double for mounting on AMW poles	111-9013	Mounting brackets. Marine-grade aluminium alloy. 5CE superior corrosion protection including PCS hardware.	320			(102 x 80) + (76 x 100)	590		8.60		

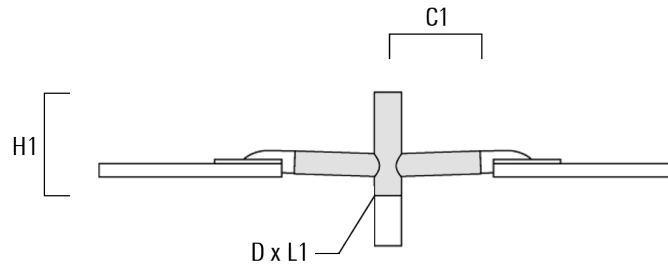

Wall and pole brackets RI

Description	Part ID	C1	D1	H1	Weight (kg)	D	H
RI-540 Wall and pole bracket	111-0179	212-255	102-133	127	1.85	102-133	110

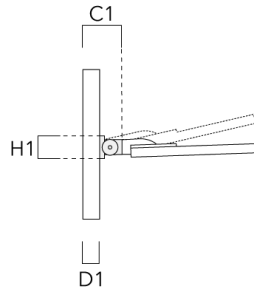

Wall and pole brackets RX

Description	Part ID	C1	D1	D2	D × L1	H1	H2	M1	M2	Weight (kg)
RX0-540 Wall bracket	111-0086	1000	140	100		450	385	30	12	5.20

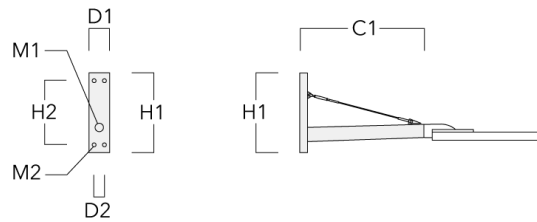

VFL540-SE LED

Description	Part ID	C1	D1	D2	D × L1	H1	H2	M1	M2	Weight (kg)
RX1-540 Pole bracket, single	111-0054	1000			76 x 130	550				6.80

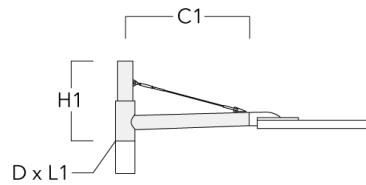

RX2-540 Pole bracket, double	111-0055	1000			76 x 130	550				9.70
------------------------------	----------	------	--	--	----------	-----	--	--	--	------

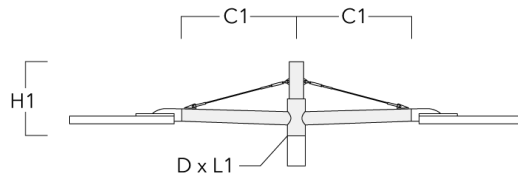

Tilt brackets TB

Description	Part ID	A	D1	D2	L	Weight (kg)
TB-540.60-10 Tilt bracket 10°	111-0636	10°	60 x 90	60 x 100	205	0.70

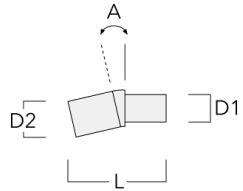

TB-540.60-15 Tilt bracket 15°	111-0637	15°	60 x 90	60 x 100	205	0.70
-------------------------------	----------	-----	---------	----------	-----	------

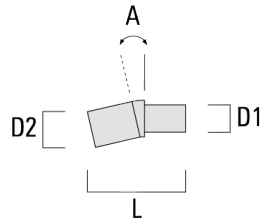

108-1256

VFL540-SE LED

we-ef

Control

R2C Ready to Connect

Description	Part ID
R2C Ready to Connect (top)	430-0019

WE-EF LIGHTING (Thailand) Co., Ltd.

57 Moo 5, Kingkaew Rd., Bangplee, 10540 Samutprakarn - Phone: +66 2 738 96 20 - Fax: +66 2 738 96 29

<https://we-ef.com/asia>

Subject to technical changes and errors. - Generated on 23/11/2024