



### Description

IP66, Class I. IK08. Marine-grade die-cast aluminium alloy. 5CE superior corrosion protection including PCS hardware. RFC™ Reflection Free Contour main lens. Silicone CCG® Controlled Compression Gasket. Luminaire is factory-sealed and does not need to be opened during installation.

Integral electronic converter with DALI interface. Advanced thermal management protects LEDs while optimising lumens output. Removable LED boards for upgrading. CAD-optimised optics for superior illumination and glare control. OLC® One LED Concept.

Variant with 2200 K or as 'Wild-Light' 2200 K combined with 3000 K with Eco Step Dim® Advanced or Motion available on request, must be specified at time of ordering.

Contact WE-EF direct or your local WE-EF sales representative for an individual solution designed to precisely meet your needs.

Including 0.5 m cable with a cable connector.

Maximum spacing for streetlighting applications depends on wattage and light distribution: 5.5 to 9 times the mounting height.

|                    |                              |
|--------------------|------------------------------|
| Weight             | 8.20 kg                      |
| Light distribution | asymmetric, side throw [S70] |
| Light source       | LED-36/36W / 350 mA - 3000 K |
| CRI                | 80                           |
| Power supply       | EC                           |
| BUG                | B1 U0 G1                     |
| LEDs               | 36                           |
| Rated input power  | 39 W                         |

### Nominal Lumen (lm)

|             |      |
|-------------|------|
| LED Lumen   | 155  |
| Total Lumen | 5580 |
| Tj          | 85   |

### Rated lumens (lm)

|             |        |
|-------------|--------|
| LED Lumen   | 143.4  |
| Total Lumen | 5163.3 |
| Ta          | 25     |

### WE-EF LIGHTING (Thailand) Co., Ltd.

57 Moo 5, Kingkaew Rd., Bangplee, 10540 Samutprakarn - Phone: +66 2 738 96 20 - Fax: +66 2 738 96 29

<https://we-ef.com/asia>

Subject to technical changes and errors. - Generated on 23/11/2024

**108-1269**

**VFL540-SE LED**

**we-ef**

Wild-Light options available on request.

**WE-EF LIGHTING (Thailand) Co., Ltd.**

57 Moo 5, Kingkaew Rd., Bangplee, 10540 Samutprakarn - Phone: +66 2 738 96 20 - Fax: +66 2 738 96 29

<https://we-ef.com/asia>

Subject to technical changes and errors. - Generated on 23/11/2024

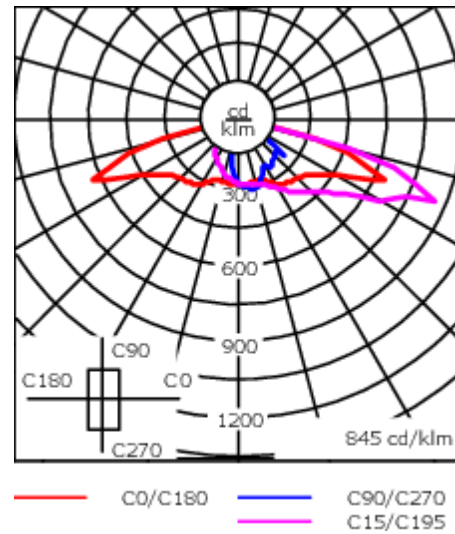
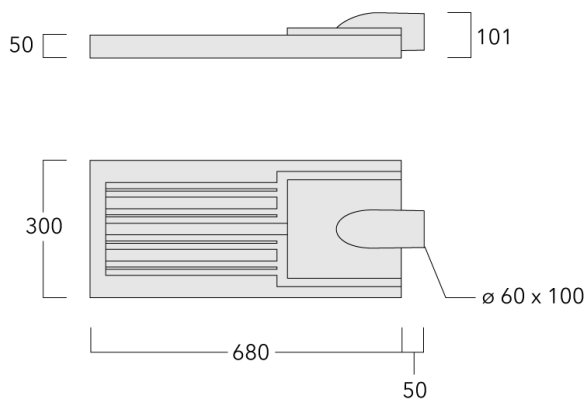

## Specifications

### Material description

|                      |  |
|----------------------|--|
| Body                 | Marine-grade, die-cast aluminium alloy   |
| Lens                 | RFC™ Reflection Free Contour main lens   |
| Colours              | <div style="display: flex; align-items: center; gap: 10px;"> <div style="width: 20px; height: 15px; background-color: black; margin-right: 5px;"></div> RAL9004 Signal black         </div> <div style="display: flex; align-items: center; gap: 10px; margin-top: 5px;"> <div style="width: 20px; height: 15px; background-color: grey; margin-right: 5px;"></div> RAL9007 Grey aluminium         </div> <div style="display: flex; align-items: center; gap: 10px; margin-top: 5px;"> <div style="width: 20px; height: 15px; background-color: darkgrey; margin-right: 5px;"></div> RAL7016 Anthracite grey         </div> <div style="display: flex; align-items: center; gap: 10px; margin-top: 5px;"> <div style="width: 20px; height: 15px; background-color: white; margin-right: 5px;"></div> RAL9016 Traffic white         </div> |
| Gasket               | Silicone CCG® Controlled Compression Gasket  |
| Fasteners            | PCS Polymer Coated Stainless Steel Hardware  |
| Ingress protection   | IP66   |
| Impact resistance    | IK08   |
| Corrosion resistance | 5CE  |
| Windage              | 0.208 m <sup>2</sup>   |

### Electrical description

|                  |   |
|------------------|---|
| Power supply     | 220-240V / 50-60 Hz                               |
| Driver / Ballast | Integral electronic converter with DALI interface |
| Power factor     | > 0.9   |

### Additional information

|            |  |
|------------|--|
| Lifetime   | Ta=25° L90B10 > 90000h   |
| BUG Rating | Please see individual Spec Sheets for classification of Backlight, Uplight and Glare |

#### WE-EF LIGHTING (Thailand) Co., Ltd.

57 Moo 5, Kingkaew Rd., Bangplee, 10540 Samutprakarn - Phone: +66 2 738 96 20 - Fax: +66 2 738 96 29

<https://we-ef.com/asia>

Subject to technical changes and errors. - Generated on 23/11/2024

**Mounting Accessories**

**Pole brackets RF**

| Description                  | Part ID  | Additional information | C1  | D × L1  | H1  | Weight (kg) | C   | H   |
|------------------------------|----------|------------------------|-----|---------|-----|-------------|-----|-----|
| RF1-540 Pole bracket, single | 111-0046 |                        | 200 | 76 x 80 | 200 | 5.60        | 200 | 300 |

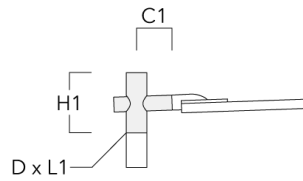

|                              |          |  |     |         |     |      |     |     |
|------------------------------|----------|--|-----|---------|-----|------|-----|-----|
| RF2-540 Pole bracket, double | 111-0047 |  | 200 | 76 x 80 | 200 | 6.20 | 200 | 300 |
|------------------------------|----------|--|-----|---------|-----|------|-----|-----|

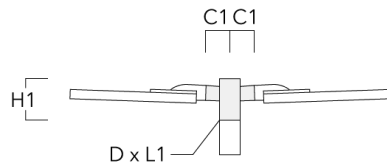

**VFL540-SE LED**

| Description  | Part ID  | Additional information   | C1  | D × L1                  | H1  | Weight (kg) | C | H |
|--|----------|--|-----|-------------------------|-----|-------------|---|---|
| Pole bracket RF1, single for mounting on AMW poles | 111-9010 | Mounting brackets. Marine-grade aluminium alloy. 5CE superior corrosion protection including PCS hardware. | 320 | (102 x 80) + (76 x 100) | 340 | 5.80        |   |   |

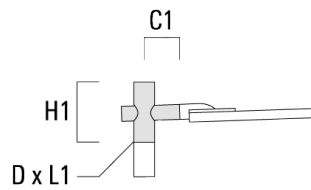

**VFL540-SE LED**

| Description  | Part ID  | Additional information   | C1  | D × L1                  | H1  | Weight (kg) | C | H |
|--|----------|--|-----|-------------------------|-----|-------------|---|---|
| Pole bracket RF2, double for mounting on AMW poles | 111-9011 | Mounting brackets. Marine-grade aluminium alloy. 5CE superior corrosion protection including PCS hardware. | 320 | (102 x 80) + (76 x 100) | 340 | 6.40        |   |   |

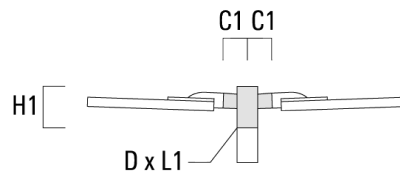

**Wall and pole brackets RE**

| Description          | Part ID  | Additional information | C1  | D1  | D2  | D × L1 | H1 | M1 | Weight (kg) | C   | H |
|----------------------|----------|------------------------|-----|-----|-----|--------|----|----|-------------|-----|---|
| Wall bracket RE0-540 | 111-0084 |                        | 180 | 230 | 195 |        |    | 12 | 2.60        | 140 |   |

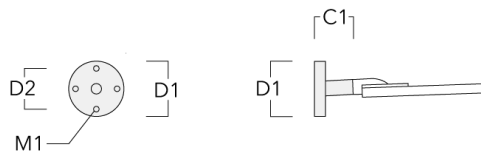

**VFL540-SE LED**

| Description                  | Part ID  | Additional information | C1  | D1 | D2 | D × L1   | H1  | M1 | Weight (kg) | C   | H   |
|------------------------------|----------|------------------------|-----|----|----|----------|-----|----|-------------|-----|-----|
| Pole bracket RE1-540, single | 111-0042 |                        | 200 |    |    | 76 x 130 | 550 |    | 7.30        | 200 | 550 |

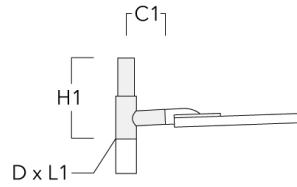

|                              |          |  |     |  |  |          |     |  |      |     |     |
|------------------------------|----------|--|-----|--|--|----------|-----|--|------|-----|-----|
| Pole bracket RE2-540, double | 111-0043 |  | 200 |  |  | 76 x 130 | 550 |  | 8.40 | 200 | 550 |
|------------------------------|----------|--|-----|--|--|----------|-----|--|------|-----|-----|

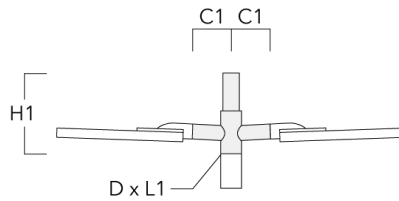

**VFL540-SE LED**

| Description  | Part ID  | Additional information  | C1  | D1 | D2 | D × L1  | H1  | M1 | Weight (kg) | C | H |
|--|----------|---|-----|----|----|---------|-----|----|-------------|---|---|
| Pole bracket RE1, single for mounting on AML-A poles | 111-9022 | Mounting brackets.<br>Marine-grade aluminium alloy. 5CE superior corrosion protection including PCS hardware. | 320 |    |    | 76 x 76 | 550 |    | 6.10        |   |   |





**VFL540-SE LED**

| Description  | Part ID  | Additional information  | C1  | D1 | D2 | D × L1  | H1  | M1 | Weight (kg) | C | H |
|--|----------|---|-----|----|----|---------|-----|----|-------------|---|---|
| Pole bracket RE2, double for mounting on AML-A poles | 111-9023 | Mounting brackets.<br>Marine-grade aluminium alloy. 5CE superior corrosion protection including PCS hardware. | 320 |    |    | 76 x 76 | 550 |    | 7.20        |   |   |

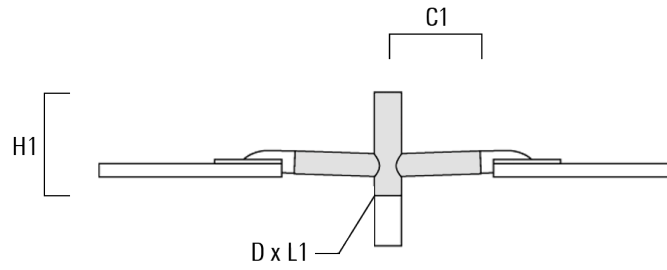

**VFL540-SE LED**

| Description  | Part ID  | Additional information  | C1  | D1 | D2 | D × L1                     | H1  | M1 | Weight (kg) | C | H |
|--|----------|---|-----|----|----|----------------------------|-----|----|-------------|---|---|
| Pole bracket RE1, single for mounting on AMW poles | 111-9012 | Mounting brackets.<br>Marine-grade aluminium alloy. 5CE superior corrosion protection including PCS hardware. | 320 |    |    | (102 x 80) +<br>(76 x 100) | 590 |    | 7.50        |   |   |



**VFL540-SE LED**

| Description  | Part ID  | Additional information  | C1  | D1 | D2 | D × L1                     | H1  | M1 | Weight (kg) | C | H |
|--|----------|---|-----|----|----|----------------------------|-----|----|-------------|---|---|
| Pole bracket RE2, double for mounting on AMW poles | 111-9013 | Mounting brackets.<br>Marine-grade aluminium alloy. 5CE superior corrosion protection including PCS hardware. | 320 |    |    | (102 x 80) +<br>(76 x 100) | 590 |    | 8.60        |   |   |

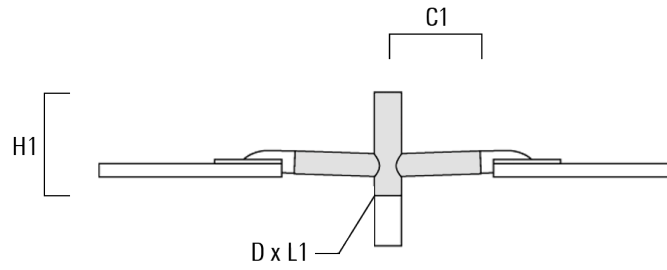

**Wall and pole brackets RI**

| Description                  | Part ID  | C1      | D1      | H1  | Weight (kg) | D       | H   |
|------------------------------|----------|---------|---------|-----|-------------|---------|-----|
| RI-540 Wall and pole bracket | 111-0179 | 212-255 | 102-133 | 127 | 1.85        | 102-133 | 110 |

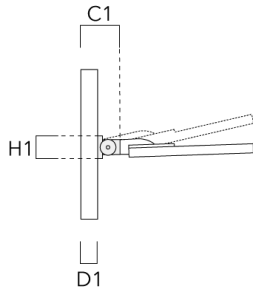

**Wall and pole brackets RX**

| Description          | Part ID  | C1   | D1  | D2  | D × L1 | H1  | H2  | M1 | M2 | Weight (kg) |
|----------------------|----------|------|-----|-----|--------|-----|-----|----|----|-------------|
| RX0-540 Wall bracket | 111-0086 | 1000 | 140 | 100 |        | 450 | 385 | 30 | 12 | 5.20        |

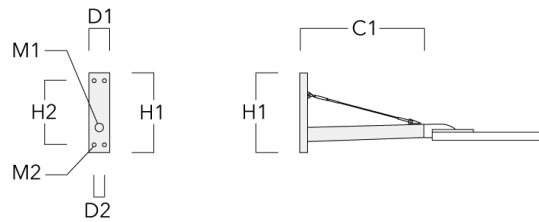

**VFL540-SE LED**

| Description                  | Part ID  | C1   | D1 | D2 | D × L1   | H1  | H2 | M1 | M2 | Weight (kg) |
|------------------------------|----------|------|----|----|----------|-----|----|----|----|-------------|
| RX1-540 Pole bracket, single | 111-0054 | 1000 |    |    | 76 x 130 | 550 |    |    |    | 6.80        |

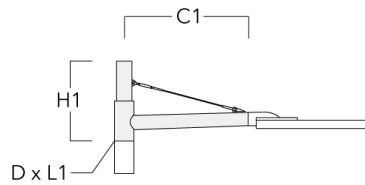

|                              |          |      |  |  |          |     |  |  |  |      |
|------------------------------|----------|------|--|--|----------|-----|--|--|--|------|
| RX2-540 Pole bracket, double | 111-0055 | 1000 |  |  | 76 x 130 | 550 |  |  |  | 9.70 |
|------------------------------|----------|------|--|--|----------|-----|--|--|--|------|

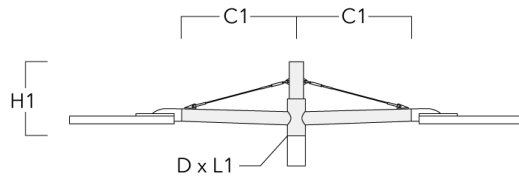

**Tilt brackets TB**

| Description                   | Part ID  | A   | D1      | D2       | L   | Weight (kg) |
|-------------------------------|----------|-----|---------|----------|-----|-------------|
| TB-540.60-10 Tilt bracket 10° | 111-0636 | 10° | 60 x 90 | 60 x 100 | 205 | 0.70        |

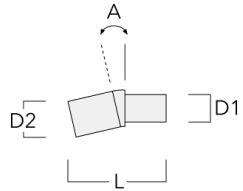

|                               |          |     |         |          |     |      |
|-------------------------------|----------|-----|---------|----------|-----|------|
| TB-540.60-15 Tilt bracket 15° | 111-0637 | 15° | 60 x 90 | 60 x 100 | 205 | 0.70 |
|-------------------------------|----------|-----|---------|----------|-----|------|

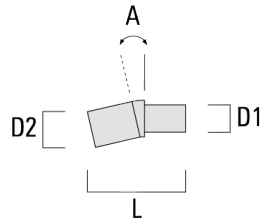

**108-1269**

**VFL540-SE LED**

**we-ef**

## **Control**

### **R2C Ready to Connect**

| Description                | Part ID  |
|----------------------------|----------|
| R2C Ready to Connect (top) | 430-0019 |

**WE-EF LIGHTING (Thailand) Co., Ltd.**

57 Moo 5, Kingkaew Rd., Bangplee, 10540 Samutprakarn - Phone: +66 2 738 96 20 - Fax: +66 2 738 96 29

<https://we-ef.com/asia>

Subject to technical changes and errors. - Generated on 23/11/2024