



### Description

IP66, Class I or Class II. IK08. Marine-grade, die-cast aluminium alloy. 5CE superior corrosion protection including PCS hardware. Silicone CCG® Controlled Compression Gasket. RFC® Reflection Free Contour main lens. Integral EC electronic converter in thermally separated compartment. DALI. CAD-optimised optics for superior illumination and glare control. OLC® One LED Concept. Factory installed LED circuit board. The luminaire is factory-sealed and does not need to be opened during installation.

Variant with 2200 K or as 'Wild-Light' 2200 K combined with 3000 K with Eco Step Dim® Advanced or Motion available on request, must be specified at time of ordering. For further details and available variants see below under additional information - Wild-Light Presentation.

Contact WE-EF direct or your local WE-EF sales representative for an individual solution designed to precisely meet your needs.

|                    |                                   |
|--------------------|-----------------------------------|
| Weight             | 5.80 kg                           |
| Light distribution | asymmetric, side throw beam [S65] |
| Light source       | LED-24/48W / 700 mA - 4000 K      |
| CRI                | 80                                |
| Power supply       | EC                                |
| LEDs               | 24                                |
| Rated input power  | 54 W                              |

### Nominal Lumen (lm)

|             |      |
|-------------|------|
| LED Lumen   | 310  |
| Total Lumen | 7440 |
| Tj          | 85   |

### Rated lumens (lm)

|             |        |
|-------------|--------|
| LED Lumen   | 278.7  |
| Total Lumen | 6689.4 |
| Ta          | 25     |

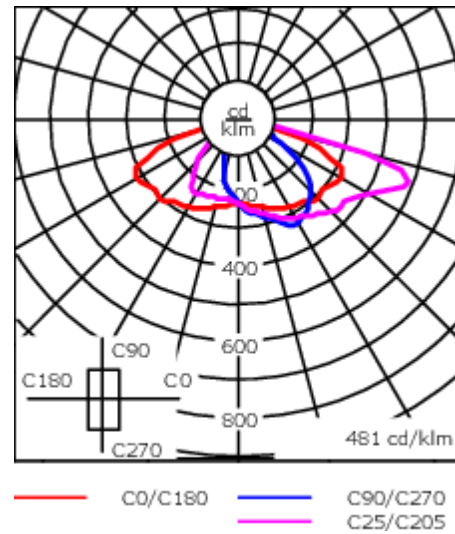
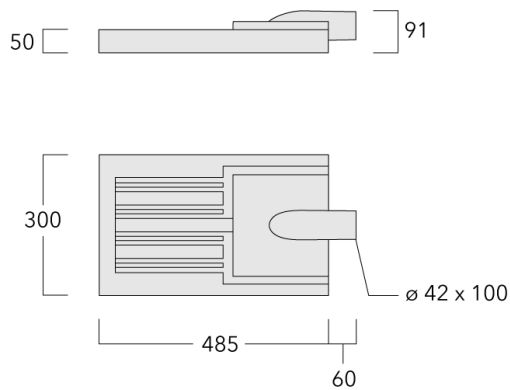

## Specifications

### Material description

|                      |  |
|----------------------|--|
| Body                 | Marine-grade, die-cast aluminium alloy   |
| Lens                 | RFC® Reflection Free Contour technology  |
| Colours              | <div style="display: flex; align-items: center;"> <div style="width: 20px; height: 15px; background-color: black; margin-right: 5px;"></div> <span>RAL9004 Signal black</span> </div> <div style="display: flex; align-items: center;"> <div style="width: 20px; height: 15px; background-color: #cccccc; margin-right: 5px;"></div> <span>RAL9006 White aluminium</span> </div> <div style="display: flex; align-items: center;"> <div style="width: 20px; height: 15px; background-color: #808080; margin-right: 5px;"></div> <span>RAL9007 Grey aluminium</span> </div> <div style="display: flex; align-items: center;"> <div style="width: 20px; height: 15px; background-color: #333333; margin-right: 5px;"></div> <span>RAL7016 Anthracite grey</span> </div> <div style="display: flex; align-items: center;"> <div style="width: 20px; height: 15px; background-color: #e0e0e0; margin-right: 5px;"></div> <span>RAL9016 Traffic white</span> </div> |
| Gasket               | Silicone CCG® Controlled Compression Gasket  |
| Fasteners            | PCS Polymer Coated Stainless Steel Hardware  |
| Ingress protection   | IP66   |
| Impact resistance    | IK08   |
| Corrosion resistance | 5CE  |
| Windage              | 0.149 m <sup>2</sup>   |

### Electrical description

|                  |  |
|------------------|--|
| Power supply     | 220-240V / 50-60 Hz                    |
| Driver / Ballast | Integral EC electronic converter. DALI |
| Power factor     | > 0.9                                  |
| Surge protection | 6/6 kV                                 |

**108-1294**

**VFL530-SE LED**

**we-ef**

**Additional information**

---

Lifetime Ta=25° L90B10 > 90000h

Energy efficiency class C-D (Light source)

---

## Control

### Eco Step Dim® Basic

| Description             | Part ID  |
|-------------------------|----------|
| Eco Step Dim® Basic LED | 430-0001 |

### Eco Step Dim® Advanced

| Description                | Part ID  |
|----------------------------|----------|
| Eco Step Dim® Advanced LED | 430-0002 |

### Eco Step Dim® Motion

| Description                   | Part ID  |
|-------------------------------|----------|
| Eco Step Dim® Motion - Linked | 430-0021 |



## VFL530-SE LED

| Description                      | Part ID  |
|----------------------------------|----------|
| Eco Step Dim® Motion - Connected | 430-0022 |



## R2C Ready to Connect

| Description                | Part ID  |
|----------------------------|----------|
| R2C Ready to Connect (top) | 430-0019 |

## Wild-Light Eco Step Dim® Advanced

| Description                       | Part ID  | Additional information  |
|-----------------------------------|----------|---|
| Wild-Light Eco Step Dim® Advanced | 430-0034 | <p>Fully automatic independent dimming pre-set, without additional installation effort, Example: Starting the night with warm white (3000 K from 20:00 to 22:00), reduced to biodiversity friendly in the heart of the night (2200 K from 22:00 to 06:00), and returning back to warm white in the early morning (3000 K from 06:00 to 07:00).</p> <p>This is the easiest to implement solution to create a nature-friendly lighting scenario, as no additional installations or external controls are needed. All pre-settings are made in the two LED drivers. The dimming values are programmed into the driver during the production of the luminaires. An optional link with sunrise and sunset times can mean additional optimisation. A customer-specific configuration is possible.</p> <p>The settings can be changed directly on the LED driver at any time (NFC). The necessary tool is standardised and can also be obtained from WE-EF as an optional extra.</p> |
| Wild-Light Motion                 | 430-0035 |   |

**Citygrid Motion On Pole**

| Description                     | Part ID  | Additional information   |
|---------------------------------|----------|--|
| Citygrid Motion - Entry-Package | 420-0011 | Citygrid Motion. Das All-in-One Gerät, das vorhandene Leuchten in ein intelligentes Lichtsystem verwandeln kann. |

**Einstiegs-Paket**

WE-EF liefert und konfiguriert Leuchten und Citygrid System einmalig ab Werk bzw. am Einsatzort. Neukonfiguration als Service abrufbar (kostenpflichtig). Gateway/App nicht inbegriffen.

Anwendungen: Kommunale Einzelprojekte, Insellösungen und Feldversuche für Smart Lighting, z.B. einzelne Straßen, Wege oder Plätze. Halböffentliche oder private Projekte, z.B. Firmengelände, Parkplatz.



**VFL530-SE LED**

| Description                          | Part ID  | Additional information  |
|--------------------------------------|----------|---|
| Citygrid Motion - Standalone-Package | 420-0012 | <p>Citygrid Motion On Pole Controller.</p> <p>The Citygrid Motion On Pole Controller is the all-in-one device that can convert existing luminaires into an intelligent lighting system.</p> <p>The standalone package:<br/>Dongle &amp; apps included; operators can configure, change and service the Citygrid system themselves (on site) using the apps on their mobile device.<br/>Applications: demarcated communal projects (street, square, district) or private projects (larger company sites, commercial estates) if qualified personnel are available for the operation of the system.</p> |



## Citygrid Motion On Luminaire

| Description                     | Part ID  | Additional information  |
|---------------------------------|----------|---|
| Citygrid Motion - Entry-Package | 420-0021 | <p>Citygrid On Luminaire - Entry Package<br/>Citygrid On Luminaire. Die Sensoren erkennen Bewegung und Verkehr beim Betreten des Sensor und Leuchtenfelds.</p> <p>Einstiegs-Paket<br/>WE-EF liefert und konfiguriert Leuchten und Citygrid System einmalig ab Werk bzw. am Einsatzort. Neukonfiguration als Service abrufbar (kostenpflichtig). Gateway/App nicht inbegriffen.</p> <p>Anwendungen: Kommunale Einzelprojekte, Insellösungen und Feldversuche für Smart Lighting, z.B. einzelne Straßen, Wege oder Plätze. Halböffentliche oder private Projekte, z.B. Firmengelände, Parkplatz. Citygrid built-in light controller with angled sensors<br/>The sensors detect motion and traffic on entering the sensor and lighting field.</p> <p>The entry-level package:<br/>WE-EF supplies and configures luminaires and the Citygrid system once ex works or on site. Reconfiguration is available as a service (chargeable). Gateway/app not included.</p> <p>Applications: individual communal projects, isolated solutions and field trials for smart lighting, e.g. single streets, paths or squares. Semi-public or private projects, e.g. company site, car park.</p> |





**VFL530-SE LED**

| Description                          | Part ID  | Additional information  |
|--------------------------------------|----------|---|
| Citygrid Motion - Standalone-Package | 420-0022 | <p>Citygrid Motion built-in light controller with angled sensors<br/>The sensors detect motion and traffic on entering the sensor and lighting field.</p> <p>The standalone package:<br/>Dongle &amp; apps included; operators can configure, change and service the Citygrid system themselves (on site) using the apps on their mobile device.<br/>Applications: demarcated communal projects (street, square, district) or private projects (larger company sites, commercial estates) if qualified personnel are available for the operation of the system.</p> |



**VFL530-SE LED**

| Description                          | Part ID  | Additional information   |
|--------------------------------------|----------|--|
| Citygrid Motion - Smart-City-Package | 420-0023 | <p>Citygrid Motion built-in light controller with angled sensors<br/>The sensors detect motion and traffic on entering the sensor and lighting field.</p> <p>The Smart-City package:<br/>Internet gateway (via mobile phone) and dashboard included; operators can configure, change and service themselves (remotely). Networked Smart-City functions (data collection, remote maintenance, etc.).<br/>Applications: larger communal projects or field trials in the context of Smart City; operator has qualified personnel (municipal utilities).</p> |



**Citygrid Motion Zhaga**

| Description                          | Part ID  | Additional information   |
|--------------------------------------|----------|--|
| Citygrid Motion - Standalone-Package | 420-0032 | Citygrid Motion Zhaga controller with sensor.<br>The compact all-in-one design turns every luminaire with a Zhaga Book 18 socket facing the street surface into motion-controlled, intelligent street & area lighting. |

The standalone package:

Dongle & apps included; operators can configure, change and service the Citygrid system themselves (on site) using the apps on their mobile device.

Applications: demarcated communal projects (street, square, district) or private projects (larger company sites, commercial estates) if qualified personnel are available for the operation of the system.



| Description                          | Part ID  | Additional information  |
|--------------------------------------|----------|---|
| Citygrid Motion - Smart-City-Package | 420-0033 | <p>Citygrid Motion Zhaga controller with sensor.<br/>The compact all-in-one design turns every luminaire with a Zhaga Book 18 socket facing the street surface into motion-controlled, intelligent street &amp; area lighting.</p> <p>The Smart-City package:<br/>Internet gateway (via mobile phone) and dashboard included; operators can configure, change and service themselves (remotely). Networked Smart-City functions (data collection, remote maintenance, etc.).<br/>Applications: larger communal projects or field trials in the context of Smart City; operator has qualified personnel (municipal utilities).</p> |



**Wild-Light Citygrid Motion On Pole**

| Description                                    | Part ID  | Additional information   |
|--|----------|--|
| Wild-Light Citygrid Motion - Entry-<br>Package | 420-1111 | Citygrid Motion On Pole Controller.<br>The Citygrid Motion On Pole Controller is the all-in-one device that can convert existing luminaires into an intelligent lighting system. |

The entry-level package:

WE-EF supplies and configures luminaires and the Citygrid system once ex works or on site. Reconfiguration is available as a service (chargeable). Gateway/app not included.

Applications: individual communal projects, isolated solutions and field trials for smart lighting, e.g. single streets, paths or squares. Semi-public or private projects, e.g. company site, car park.



## VFL530-SE LED

| Description                                     | Part ID  | Additional information  |
|---|----------|---|
| Wild-Light Citygrid Motion - Standalone-Package | 420-1112 | <p>Citygrid Motion On Pole Controller for Wild-Light.</p> <p>The Citygrid Motion On Pole Controller is the all-in-one device that can convert existing luminaires into an intelligent lighting system.</p> <p>The standalone package:<br/>Dongle &amp; apps included; operators can configure, change and service the Citygrid system themselves (on site) using the apps on their mobile device.</p> <p>Applications: demarcated communal projects (street, square, district) or private projects (larger company sites, commercial estates) if qualified personnel are available for the operation of the system.</p> |



## VFL530-SE LED

| Description                                     | Part ID  | Additional information   |
|---|----------|--|
| Wild-Light Citygrid Motion - Smart-City-Package | 420-1113 | <p>Citygrid Motion On Pole Controller for Wild-Light.</p> <p>The Citygrid Motion On Pole Controller is the all-in-one device that can convert existing luminaires into an intelligent lighting system.</p> <p>The Smart-City package:<br/>Internet gateway (via mobile phone) and dashboard included; operators can configure, change and service themselves (remotely). Networked Smart-City functions (data collection, remote maintenance, etc.).</p> <p>Applications: larger communal projects or field trials in the context of Smart City; operator has qualified personnel (municipal utilities).</p> |



**Mounting Accessories**

**Pole brackets RF**

| Description                  | Part ID  | C1  | D × L1  | H1  | Weight (kg) | C   | H   |
|------------------------------|----------|-----|---------|-----|-------------|-----|-----|
| RF1-530 Pole bracket, single | 111-0044 | 190 | 76 x 80 | 275 | 2.30        | 190 | 275 |



|                              |          |     |         |     |      |     |     |
|------------------------------|----------|-----|---------|-----|------|-----|-----|
| RF2-530 Pole bracket, double | 111-0045 | 190 | 76 x 80 | 275 | 3.00 | 190 | 275 |
|------------------------------|----------|-----|---------|-----|------|-----|-----|





**Wall and pole brackets RE**

| Description          | Part ID  | C1  | D1  | D2  | D × L1 | H1 | M1 | Weight (kg) | C   | H |
|----------------------|----------|-----|-----|-----|--------|----|----|-------------|-----|---|
| RE0-530 Wall bracket | 111-0052 | 180 | 230 | 195 |        |    | 12 | 2.90        | 120 |   |

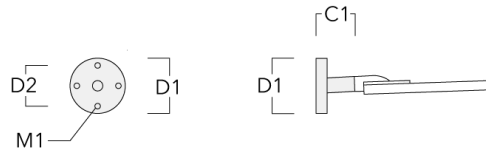

|                              |          |     |  |  |         |     |  |      |     |     |
|------------------------------|----------|-----|--|--|---------|-----|--|------|-----|-----|
| RE1-530 Pole bracket, single | 111-0040 | 180 |  |  | 76 x 80 | 400 |  | 3.20 | 180 | 400 |
|------------------------------|----------|-----|--|--|---------|-----|--|------|-----|-----|

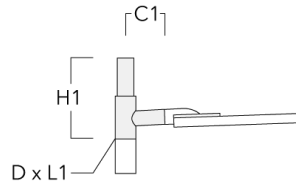

**VFL530-SE LED**

| Description                  | Part ID  | C1  | D1 | D2 | D × L1  | H1  | M1 | Weight (kg) | C   | H   |
|------------------------------|----------|-----|----|----|---------|-----|----|-------------|-----|-----|
| RE2-530 Pole bracket, double | 111-0041 | 180 |    |    | 76 x 80 | 400 |    | 3.60        | 180 | 400 |

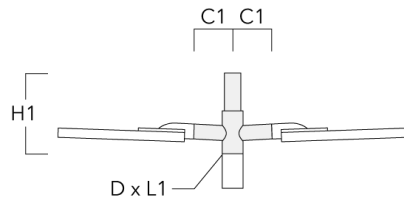

**Wall and pole brackets RI**

| Description                  | Part ID  | C1      | D1     | H1  | Weight (kg) | D       | H  |
|------------------------------|----------|---------|--------|-----|-------------|---------|----|
| RI-530 Wall and pole bracket | 111-0178 | 184-255 | 76-133 | 127 | 1.85        | 102-133 | 96 |

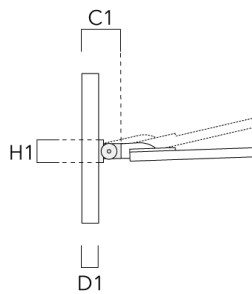

**Wall and pole brackets RX**

| Description          | Part ID  | C1  | D1  | D2  | D × L1 | H1  | H2  | M1 | M2 | Weight (kg) |
|----------------------|----------|-----|-----|-----|--------|-----|-----|----|----|-------------|
| RX0-530 Wall bracket | 111-0053 | 710 | 140 | 100 |        | 350 | 285 | 30 | 12 | 3.30        |

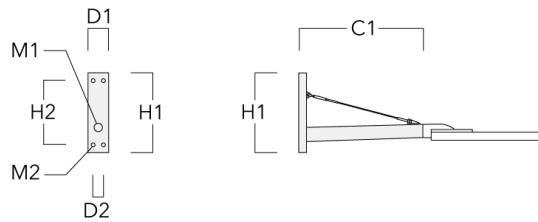

|                              |          |     |  |  |         |     |  |  |  |      |
|------------------------------|----------|-----|--|--|---------|-----|--|--|--|------|
| RX1-530 Pole bracket, single | 111-0088 | 710 |  |  | 76 x 80 | 400 |  |  |  | 4.50 |
|------------------------------|----------|-----|--|--|---------|-----|--|--|--|------|

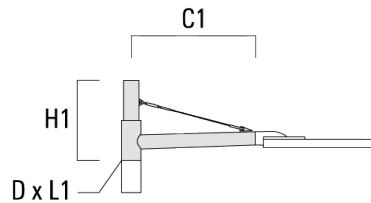

**VFL530-SE LED**

| Description                  | Part ID  | C1  | D1 | D2 | D x L1  | H1  | H2 | M1 | M2 | Weight (kg) |
|------------------------------|----------|-----|----|----|---------|-----|----|----|----|-------------|
| RX2-530 Pole bracket, double | 111-0089 | 710 |    |    | 76 x 80 | 400 |    |    |    | 6.20        |



**Tilt brackets TB**

| Description                   | Part ID  | A   | D1      | D2       | L   | Weight (kg) |
|-------------------------------|----------|-----|---------|----------|-----|-------------|
| TB-530.42-10 Tilt bracket 10° | 111-0639 | 10° | 42 x 90 | 42 x 100 | 205 | 0.50        |

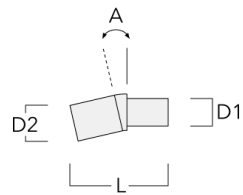

**VFL530-SE LED**

---

| Description                   | Part ID  | A   | D1      | D2       | L   | Weight (kg) |
|-------------------------------|----------|-----|---------|----------|-----|-------------|
| TB-530.42-15 Tilt bracket 15° | 111-0640 | 15° | 42 x 90 | 42 x 100 | 205 | 0.50        |

---



## Optical Accessories

### Light shield

| Description | Part ID  | Additional information  |
|-------------|----------|---|
| LS180-[A60] | 430-0038 | Light shield LS180 to greatly reduce or eliminate light pollution.<br>PA injection moulded component, black matt.<br>Suitable for asymmetric light distribution [A60].                          |
| LS180       | 430-0029 | Glare Shield for backlight spill. Glare Shield factory-installed or available as retrofit kit.<br>Suitable for [S60], [S65], [S70], [R65], [P65] lenses. Must be specified at time of ordering. |