



Description

IP66, Class I. IK08. Marine-grade die-cast aluminium alloy. 5CE superior corrosion protection including PCS hardware. RFC™ Reflection Free Contour main lens. Silicone CCG® Controlled Compression Gasket. Luminaire is factory-sealed and does not need to be opened during installation.

Integral electronic converter with DALI interface. Advanced thermal management protects LEDs while optimising lumens output. Removable LED boards for upgrading. CAD-optimised optics for superior illumination and glare control. OLC® One LED Concept.

Variant with 2200 K or as 'Wild-Light' 2200 K combined with 3000 K with Eco Step Dim® Advanced or Motion available on request, must be specified at time of ordering.

Contact WE-EF direct or your local WE-EF sales representative for an individual solution designed to precisely meet your needs.

Including 0.5 m cable with a cable connector.

Maximum spacing for streetlighting applications depends on wattage and light distribution: 5.5 to 9 times the mounting height.

Weight	5.80 kg
Light distribution	rectangular, side throw [R65]
Light source	LED-24/48W / 700 mA - 4000 K
CRI	80
Power supply	EC
BUG	B1 U0 G1
LEDs	24
Rated input power	54 W

Nominal Lumen (lm)

LED Lumen	310
Total Lumen	7440
Tj	85

Rated lumens (lm)

LED Lumen	257.8
Total Lumen	6187.9
Ta	25

WE-EF LIGHTING (Thailand) Co., Ltd.

57 Moo 5, Kingkaew Rd., Bangplee, 10540 Samutprakarn - Phone: +66 2 738 96 20 - Fax: +66 2 738 96 29

<https://we-ef.com/asia>

Subject to technical changes and errors. - Generated on 23/11/2024

108-1296

VFL530-SE LED

we-ef

Wild-Light options available on request.

WE-EF LIGHTING (Thailand) Co., Ltd.

57 Moo 5, Kingkaew Rd., Bangplee, 10540 Samutprakarn - Phone: +66 2 738 96 20 - Fax: +66 2 738 96 29

<https://we-ef.com/asia>

Subject to technical changes and errors. - Generated on 23/11/2024

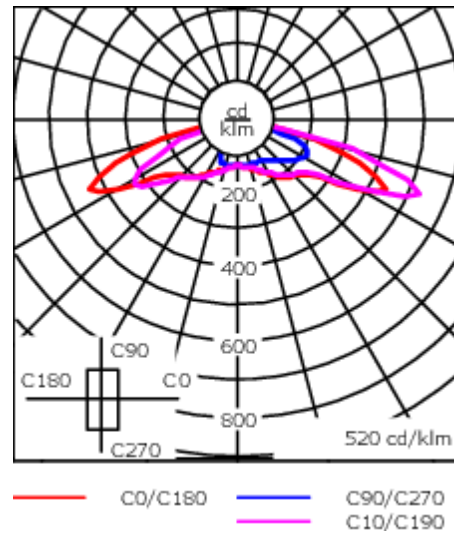
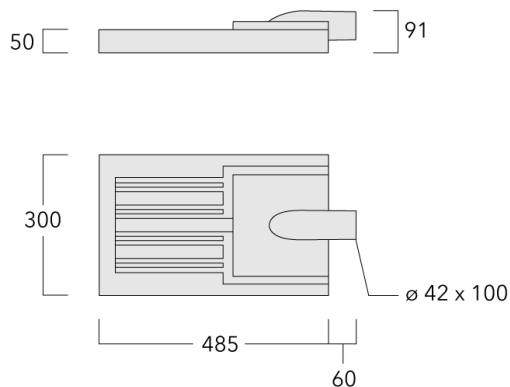

Specifications

Material description

Body	Marine-grade, die-cast aluminium alloy
Lens	RFC™ Reflection Free Contour main lens
Colours	<div style="display: flex; align-items: center;"> <div style="width: 20px; height: 15px; background-color: black; margin-right: 5px;"></div> RAL9004 Signal black </div> <div style="display: flex; align-items: center; margin-top: 5px;"> <div style="width: 20px; height: 15px; background-color: grey; margin-right: 5px;"></div> RAL9007 Grey aluminium </div> <div style="display: flex; align-items: center; margin-top: 5px;"> <div style="width: 20px; height: 15px; background-color: darkgrey; margin-right: 5px;"></div> RAL7016 Anthracite grey </div> <div style="display: flex; align-items: center; margin-top: 5px;"> <div style="width: 20px; height: 15px; background-color: lightgrey; margin-right: 5px;"></div> RAL9016 Traffic white </div>
Gasket	Silicone CCG® Controlled Compression Gasket
Fasteners	PCS Polymer Coated Stainless Steel Hardware
Ingress protection	IP66
Impact resistance	IK08
Corrosion resistance	5CE
Windage	0.149 m ²

Electrical description

Power supply	220-240V / 50-60 Hz
Driver / Ballast	Integral electronic converter with DALI interface
Power factor	> 0.9

Additional information

Lifetime	Ta=25° L90B10 > 90000h
BUG Rating	Please see individual Spec Sheets for classification of Backlight, Uplight and Glare

WE-EF LIGHTING (Thailand) Co., Ltd.

57 Moo 5, Kingkaew Rd., Bangplee, 10540 Samutprakarn - Phone: +66 2 738 96 20 - Fax: +66 2 738 96 29

<https://we-ef.com/asia>

Subject to technical changes and errors. - Generated on 23/11/2024

Mounting Accessories

Pole brackets RF

Description	Part ID	C1	D × L1	H1	Weight (kg)	C	H
RF1-530 Pole bracket, single	111-0044	190	76 x 80	275	4.70	190	275

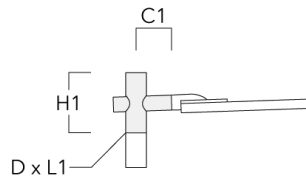

RF2-530 Pole bracket, double	111-0045	190	76 x 80	275	5.00	190	275
------------------------------	----------	-----	---------	-----	------	-----	-----

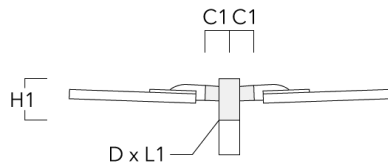

Wall and pole brackets RE

Description	Part ID	Additional information	C1	D1	D2	D × L1	H1	M1	Weight(kg)	C	H
Wall bracket RE0-530	111-0052		180	230	195			12	2.50	120	

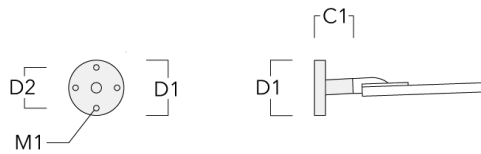

Pole bracket RE1-530, single	111-0040		180			76 x 80	400		5.50	180	400
------------------------------	----------	--	-----	--	--	---------	-----	--	------	-----	-----

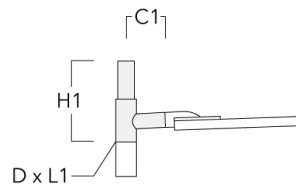

VFL530-SE LED

Description	Part ID	Additional information	C1	D1	D2	D × L1	H1	M1	Weight (kg)	C	H
Pole bracket RE2-530, double	111-0041		180			76 x 80	400		6.10	180	400

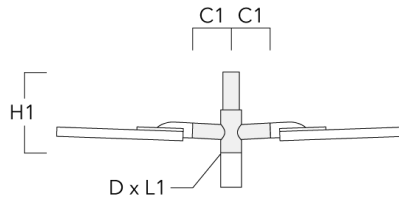

Pole bracket RE1, single for mounting on AML-A poles	111-9020	Mounting brackets. Marine-grade aluminium alloy. 5CE superior corrosion protection including PCS hardware.	280			76 x 76	400		4.50		
--	----------	--	-----	--	--	---------	-----	--	------	--	--

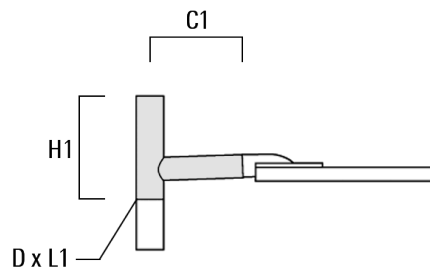

VFL530-SE LED

Description	Part ID	Additional information	C1	D1	D2	D × L1	H1	M1	Weight (kg)	C	H
Pole bracket RE2, double for mounting on AML-A poles	111-9021		280			76 x 76	400		5.00		

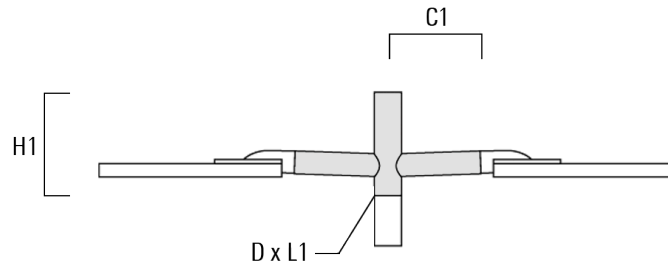

Wall and pole brackets RI

Description	Part ID	C1	D1	H1	Weight (kg)	D	H
RI-530 Wall and pole bracket	111-0178	184-255	76-133	127	1.85	102-133	96

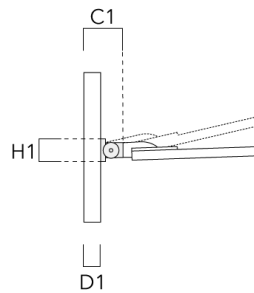

Wall and pole brackets RX

Description	Part ID	C1	D1	D2	D × L1	H1	H2	M1	M2	Weight (kg)
RX0-530 Wall bracket	111-0053	710	140	100		350	285	30	12	3.30

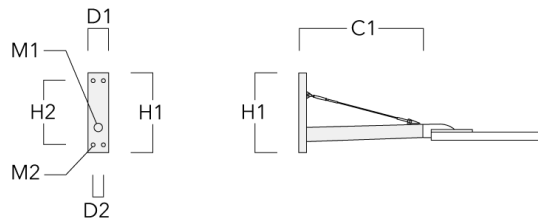

RX1-530 Pole bracket, single	111-0088	710			76 x 80	400				4.50
------------------------------	----------	-----	--	--	---------	-----	--	--	--	------

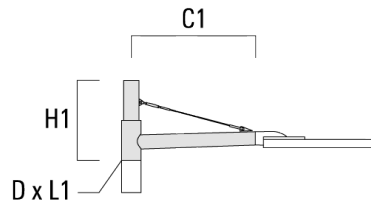

VFL530-SE LED

Description	Part ID	C1	D1	D2	D × L1	H1	H2	M1	M2	Weight (kg)
RX2-530 Pole bracket, double	111-0089	710			76 x 80	400				6.20

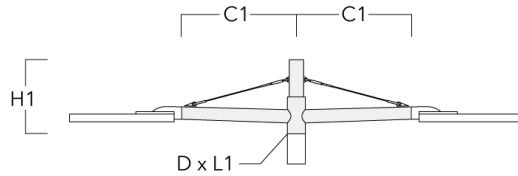

Tilt brackets TB

Description	Part ID	A	D1	D2	L	Weight (kg)
TB-530.42-10 Tilt bracket 10°	111-0639	10°	42 x 90	42 x 100	205	0.50

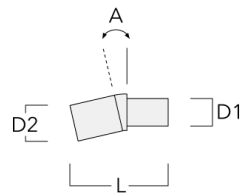

VFL530-SE LED

Description	Part ID	A	D1	D2	L	Weight (kg)
TB-530.42-15 Tilt bracket 15°	111-0640	15°	42 x 90	42 x 100	205	0.50

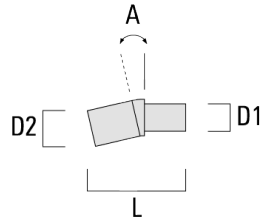

108-1296

VFL530-SE LED

we-ef

Control

R2C Ready to Connect

Description	Part ID
R2C Ready to Connect (top)	430-0019

WE-EF LIGHTING (Thailand) Co., Ltd.

57 Moo 5, Kingkaew Rd., Bangplee, 10540 Samutprakarn - Phone: +66 2 738 96 20 - Fax: +66 2 738 96 29

<https://we-ef.com/asia>

Subject to technical changes and errors. - Generated on 23/11/2024