



Description

IP66, Class I or Class II. IK08. Marine-grade, die-cast aluminium alloy. 5CE superior corrosion protection including PCS hardware. Silicone CCG® Controlled Compression Gasket. RFC® Reflection Free Contour main lens. Integral EC electronic converter in thermally separated compartment. DALI. CAD-optimised optics for superior illumination and glare control. OLC® One LED Concept. Factory installed LED circuit board. The luminaire is factory-sealed and does not need to be opened during installation.

Variant with 2200 K or as 'Wild-Light' 2200 K combined with 3000 K with Eco Step Dim® Advanced or Motion available on request, must be specified at time of ordering. For further details and available variants see below under additional information - Wild-Light Presentation.

Contact WE-EF direct or your local WE-EF sales representative for an individual solution designed to precisely meet your needs.

Photometric files (IES, LDT) for light distributions [S60] [S65] [S70] [R65] [P65] [A60] with Backlight Shield on request.

Weight	5.80 kg
Light distribution	rectangular, side throw [R65]
Light source	LED-12/24W / 700 mA - 4000 K
CRI	80
Power supply	EC
LEDs	12
Rated input power	27 W
Nominal Lumen (lm)	
LED Lumen	310
Total Lumen	3720
Tj	85
Rated lumens (lm)	
LED Lumen	257.8
Total Lumen	3094
Ta	25

VFL530-SE LED

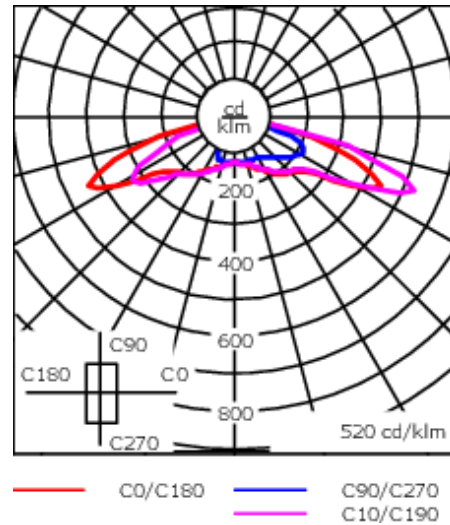
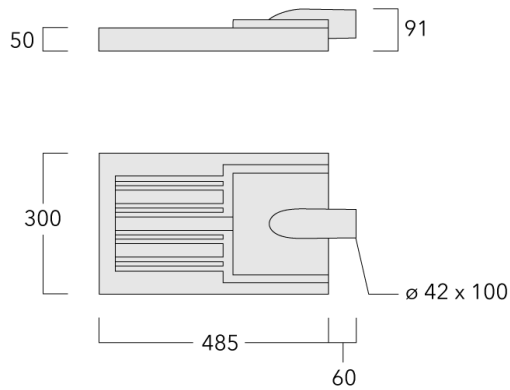

Specifications

Material description

Body	Marine-grade, die-cast aluminium alloy
Lens	RFC® Reflection Free Contour technology
Colours	<div style="display: flex; align-items: center;"> <div style="width: 20px; height: 15px; background-color: black; margin-right: 5px;"></div> <div>RAL9004 Signal black</div> </div> <div style="display: flex; align-items: center; margin-top: 5px;"> <div style="width: 20px; height: 15px; background-color: #cccccc; margin-right: 5px;"></div> <div>RAL9006 White aluminium</div> </div> <div style="display: flex; align-items: center; margin-top: 5px;"> <div style="width: 20px; height: 15px; background-color: #808080; margin-right: 5px;"></div> <div>RAL9007 Grey aluminium</div> </div> <div style="display: flex; align-items: center; margin-top: 5px;"> <div style="width: 20px; height: 15px; background-color: #333333; margin-right: 5px;"></div> <div>RAL7016 Anthracite grey</div> </div> <div style="display: flex; align-items: center; margin-top: 5px;"> <div style="width: 20px; height: 15px; background-color: #e0e0e0; margin-right: 5px;"></div> <div>RAL9016 Traffic white</div> </div>
Gasket	Silicone CCG® Controlled Compression Gasket
Fasteners	PCS Polymer Coated Stainless Steel Hardware
Ingress protection	IP66
Impact resistance	IK08
Corrosion resistance	5CE
Windage	0.149 m ²

Electrical description

Power supply	220-240V / 50-60 Hz
Driver / Ballast	Integral EC electronic converter. DALI
Power factor	> 0.9
Surge protection	6/6 kV

Additional information

Lifetime Ta=25° L90B10 > 90000h

Energy efficiency class C-D (Light source)

Control

Eco Step Dim® Basic

Description	Part ID
Eco Step Dim® Basic LED	430-0001

Eco Step Dim® Advanced

Description	Part ID
Eco Step Dim® Advanced LED	430-0002

Eco Step Dim® Motion

Description	Part ID
Eco Step Dim® Motion - Linked	430-0021



VFL530-SE LED

Description	Part ID
Eco Step Dim® Motion - Connected	430-0022

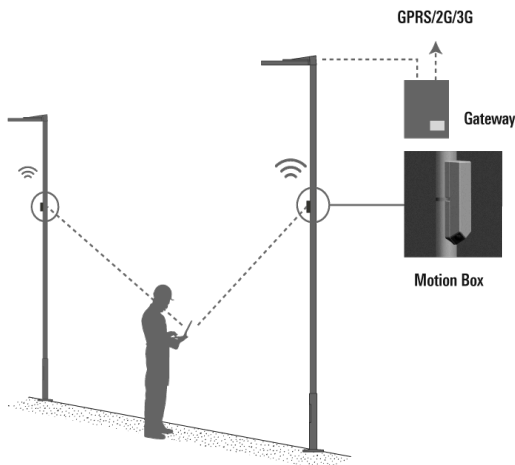

R2C Ready to Connect

Description	Part ID
R2C Ready to Connect (top)	430-0019

Wild-Light Eco Step Dim® Advanced

Description	Part ID	Additional information
Wild-Light Eco Step Dim® Advanced	430-0034	<p>Fully automatic independent dimming pre-set, without additional installation effort, Example: Starting the night with warm white (3000 K from 20:00 to 22:00), reduced to biodiversity friendly in the heart of the night (2200 K from 22:00 to 06:00), and returning back to warm white in the early morning (3000 K from 06:00 to 07:00).</p> <p>This is the easiest to implement solution to create a nature-friendly lighting scenario, as no additional installations or external controls are needed. All pre-settings are made in the two LED drivers. The dimming values are programmed into the driver during the production of the luminaires. An optional link with sunrise and sunset times can mean additional optimisation. A customer-specific configuration is possible.</p> <p>The settings can be changed directly on the LED driver at any time (NFC). The necessary tool is standardised and can also be obtained from WE-EF as an optional extra.</p>
Wild-Light Motion	430-0035	

Citygrid Motion On Pole

Description	Part ID	Additional information
Citygrid Motion - Entry-Package	420-0011	<p>Citygrid Motion. Das All-in-One Gerät, das vorhandene Leuchten in ein intelligentes Lichtsystem verwandeln kann.</p> <p>Einstiegs-Paket WE-EF liefert und konfiguriert Leuchten und Citygrid System einmalig ab Werk bzw. am Einsatzort. Neukonfiguration als Service abrufbar (kostenpflichtig). Gateway/App nicht inbegriffen.</p> <p>Anwendungen: Kommunale Einzelprojekte, Insellösungen und Feldversuche für Smart Lighting, z.B. einzelne Straßen, Wege oder Plätze. Halböffentliche oder private Projekte, z.B. Firmengelände, Parkplatz.</p>



VFL530-SE LED

Description	Part ID	Additional information
Citygrid Motion - Standalone-Package	420-0012	<p>Citygrid Motion On Pole Controller. The Citygrid Motion On Pole Controller is the all-in-one device that can convert existing luminaires into an intelligent lighting system.</p> <p>The standalone package: Dongle & apps included; operators can configure, change and service the Citygrid system themselves (on site) using the apps on their mobile device. Applications: demarcated communal projects (street, square, district) or private projects (larger company sites, commercial estates) if qualified personnel are available for the operation of the system.</p>



Citygrid Motion On Luminaire

Description	Part ID	Additional information
Citygrid Motion - Entry-Package	420-0021	<p>Citygrid On Luminaire - Entry Package Citygrid On Luminaire. Die Sensoren erkennen Bewegung und Verkehr beim Betreten des Sensor und Leuchtenfelds.</p> <p>Einstiegs-Paket WE-EF liefert und konfiguriert Leuchten und Citygrid System einmalig ab Werk bzw. am Einsatzort. Neukonfiguration als Service abrufbar (kostenpflichtig). Gateway/App nicht inbegriffen.</p> <p>Anwendungen: Kommunale Einzelprojekte, Insellösungen und Feldversuche für Smart Lighting, z.B. einzelne Straßen, Wege oder Plätze. Halböffentliche oder private Projekte, z.B. Firmengelände, Parkplatz. Citygrid built-in light controller with angled sensors The sensors detect motion and traffic on entering the sensor and lighting field.</p> <p>The entry-level package: WE-EF supplies and configures luminaires and the Citygrid system once ex works or on site. Reconfiguration is available as a service (chargeable). Gateway/app not included.</p> <p>Applications: individual communal projects, isolated solutions and field trials for smart lighting, e.g. single streets, paths or squares. Semi-public or private projects, e.g. company site, car park.</p>

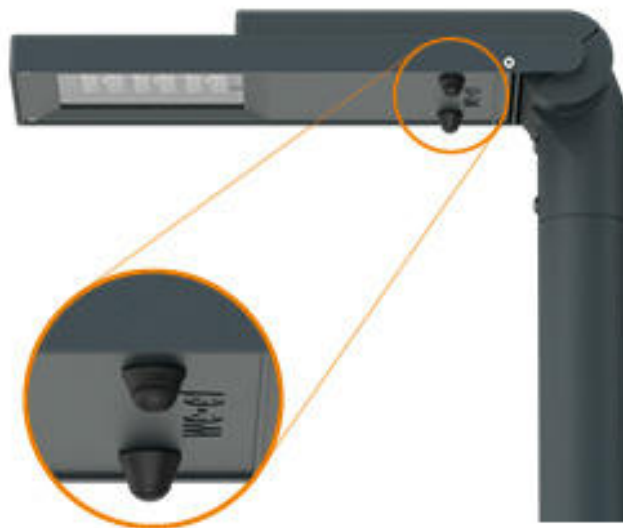

VFL530-SE LED

Description	Part ID	Additional information
Citygrid Motion - Standalone-Package	420-0022	Citygrid Motion built-in light controller with angled sensors The sensors detect motion and traffic on entering the sensor and lighting field.

The standalone package:

Dongle & apps included; operators can configure, change and service the Citygrid system themselves (on site) using the apps on their mobile device.

Applications: demarcated communal projects (street, square, district) or private projects (larger company sites, commercial estates) if qualified personnel are available for the operation of the system.

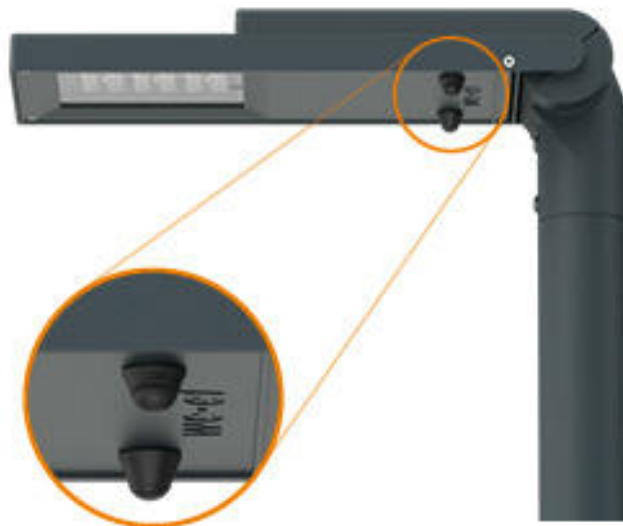

VFL530-SE LED

Description	Part ID	Additional information
Citygrid Motion - Smart-City-Package	420-0023	<p>Citygrid Motion built-in light controller with angled sensors The sensors detect motion and traffic on entering the sensor and lighting field.</p> <p>The Smart-City package: Internet gateway (via mobile phone) and dashboard included; operators can configure, change and service themselves (remotely). Networked Smart-City functions (data collection, remote maintenance, etc.). Applications: larger communal projects or field trials in the context of Smart City; operator has qualified personnel (municipal utilities).</p>

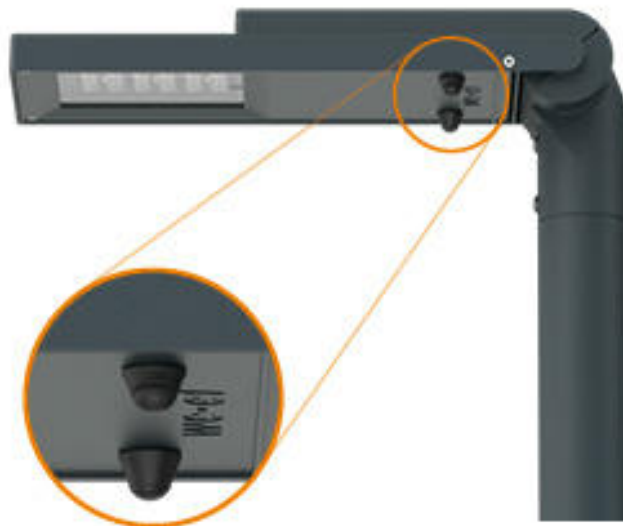

Citygrid Motion Zhaga

Description	Part ID	Additional information
Citygrid Motion - Standalone-Package	420-0032	<p>Citygrid Motion Zhaga controller with sensor.</p> <p>The compact all-in-one design turns every luminaire with a Zhaga Book 18 socket facing the street surface into motion-controlled, intelligent street & area lighting.</p> <p>The standalone package: Dongle & apps included; operators can configure, change and service the Citygrid system themselves (on site) using the apps on their mobile device. Applications: demarcated communal projects (street, square, district) or private projects (larger company sites, commercial estates) if qualified personnel are available for the operation of the system.</p>



VFL530-SE LED

Description	Part ID	Additional information
Citygrid Motion - Smart-City-Package	420-0033	<p>Citygrid Motion Zhaga controller with sensor.</p> <p>The compact all-in-one design turns every luminaire with a Zhaga Book 18 socket facing the street surface into motion-controlled, intelligent street & area lighting.</p> <p>The Smart-City package:</p> <p>Internet gateway (via mobile phone) and dashboard included; operators can configure, change and service themselves (remotely). Networked Smart-City functions (data collection, remote maintenance, etc.).</p> <p>Applications: larger communal projects or field trials in the context of Smart City; operator has qualified personnel (municipal utilities).</p>



Wild-Light Citygrid Motion On Pole

Description	Part ID	Additional information
Wild-Light Citygrid Motion - Entry- Package	420-1111	<p>Citygrid Motion On Pole Controller.</p> <p>The Citygrid Motion On Pole Controller is the all-in-one device that can convert existing luminaires into an intelligent lighting system.</p> <p>The entry-level package: WE-EF supplies and configures luminaires and the Citygrid system once ex works or on site. Reconfiguration is available as a service (chargeable). Gateway/app not included.</p> <p>Applications: individual communal projects, isolated solutions and field trials for smart lighting, e.g. single streets, paths or squares. Semi-public or private projects, e.g. company site, car park.</p>



VFL530-SE LED

Description	Part ID	Additional information
Wild-Light Citygrid Motion - Standalone-Package	420-1112	<p>Citygrid Motion On Pole Controller for Wild-Light.</p> <p>The Citygrid Motion On Pole Controller is the all-in-one device that can convert existing luminaires into an intelligent lighting system.</p> <p>The standalone package:</p> <p>Dongle & apps included; operators can configure, change and service the Citygrid system themselves (on site) using the apps on their mobile device.</p> <p>Applications: demarcated communal projects (street, square, district) or private projects (larger company sites, commercial estates) if qualified personnel are available for the operation of the system.</p>



VFL530-SE LED

Description	Part ID	Additional information
Wild-Light Citygrid Motion - Smart-City-Package	420-1113	<p>Citygrid Motion On Pole Controller for Wild-Light.</p> <p>The Citygrid Motion On Pole Controller is the all-in-one device that can convert existing luminaires into an intelligent lighting system.</p> <p>The Smart-City package:</p> <p>Internet gateway (via mobile phone) and dashboard included; operators can configure, change and service themselves (remotely). Networked Smart-City functions (data collection, remote maintenance, etc.).</p> <p>Applications: larger communal projects or field trials in the context of Smart City; operator has qualified personnel (municipal utilities).</p>



Mounting Accessories

Pole brackets RF

Description	Part ID	C1	D × L1	H1	Weight (kg)	C	H
RF1-530 Pole bracket, single	111-0044	190	76 x 80	275	2.30	190	275

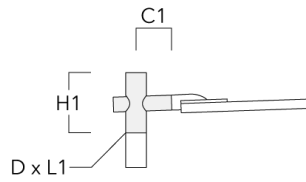

RF2-530 Pole bracket, double	111-0045	190	76 x 80	275	3.00	190	275
------------------------------	----------	-----	---------	-----	------	-----	-----

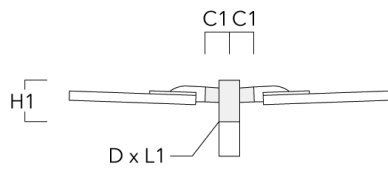

Wall and pole brackets RE

Description	Part ID	C1	D1	D2	D x L1	H1	M1	Weight (kg)	C	H
RE0-530 Wall bracket	111-0052	180	230	195			12	2.90	120	

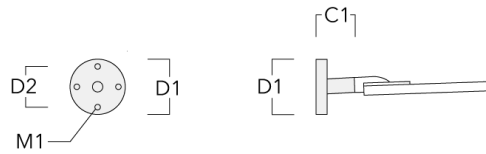

RE1-530 Pole bracket, single	111-0040	180			76 x 80	400		3.20	180	400
------------------------------	----------	-----	--	--	---------	-----	--	------	-----	-----

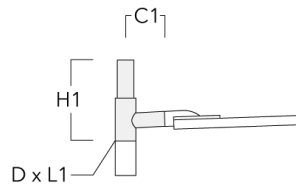

VFL530-SE LED

Description	Part ID	C1	D1	D2	D × L1	H1	M1	Weight (kg)	C	H
RE2-530 Pole bracket, double	111-0041	180			76 x 80	400		3.60	180	400

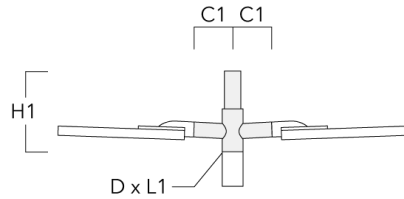

Wall and pole brackets RI

Description	Part ID	C1	D1	H1	Weight (kg)	D	H
RI-530 Wall and pole bracket	111-0178	184-255	76-133	127	1.85	102-133	96

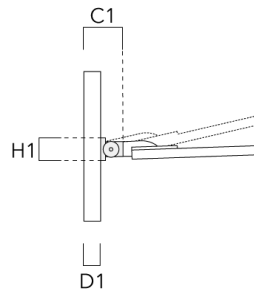

VFL530-SE LED

Wall and pole brackets RX

Description	Part ID	C1	D1	D2	D x L1	H1	H2	M1	M2	Weight (kg)
RX0-530 Wall bracket	111-0053	710	140	100		350	285	30	12	3.30

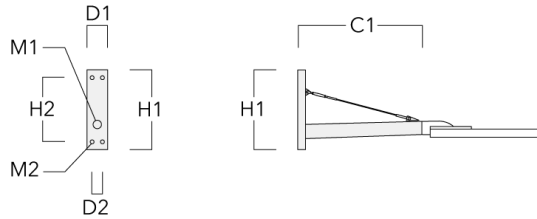

RX1-530 Pole bracket, single	111-0088	710			76 x 80	400				4.50
------------------------------	----------	-----	--	--	---------	-----	--	--	--	------

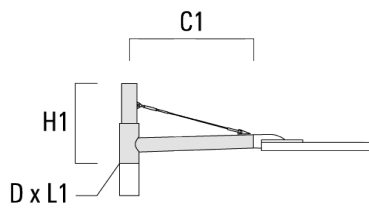

VFL530-SE LED

Description	Part ID	C1	D1	D2	D x L1	H1	H2	M1	M2	Weight (kg)
RX2-530 Pole bracket, double	111-0089	710			76 x 80	400				6.20

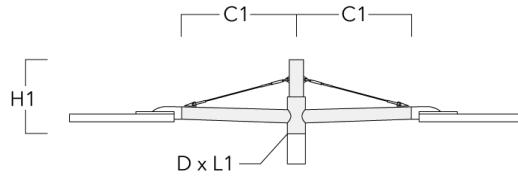

Tilt brackets TB

Description	Part ID	A	D1	D2	L	Weight (kg)
TB-530.42-10 Tilt bracket 10°	111-0639	10°	42 x 90	42 x 100	205	0.50

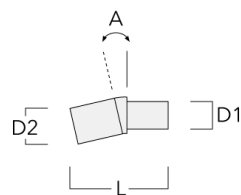

VFL530-SE LED

Description	Part ID	A	D1	D2	L	Weight (kg)
TB-530.42-15 Tilt bracket 15°	111-0640	15°	42 x 90	42 x 100	205	0.50

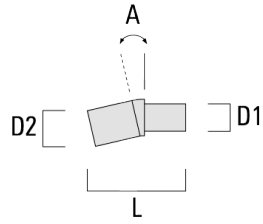

Optical Accessories**Light shield**

Description	Part ID	Additional information
LS180-[A60]	430-0038	Light shield LS180 to greatly reduce or eliminate light pollution. PA injection moulded component, black matt. Suitable for asymmetric light distribution [A60].
LS180	430-0029	Glare Shield for backlight spill. Glare Shield factory-installed or available as retrofit kit. Suitable for [S60], [S65], [S70], [R65], [P65] lenses. Must be specified at time of ordering.